



**EXPLANATORY NOTE RELATED TO THE PUBLIC CONSULTATION ON THE TERMS AND CONDITIONS FOR OUTAGE PLANNING AGENT, TERMS AND CONDITIONS FOR THE SCHEDULING AGENT AND RULES FOR COORDINATION AND CONGESTION MANAGEMENT**

29/03/2024

## TABLE OF CONTENTS

---

<b>Table of Contents .....</b>	<b>2</b>
<b>1. Practical information .....</b>	<b>3</b>
<b>2. Introduction .....</b>	<b>4</b>
<b>3. General evolutions introduced by iCAROS design in phase 1 .....</b>	<b>7</b>
3.1. New terminology introduced by iCAROS design.....	7
3.2. Coordinability of Technical Facilities .....	11
3.3. Data completeness and consistency control of exchanged data.....	12
<b>4. Specific evolutions related to the Outage planning process .....</b>	<b>14</b>
4.1. Participation to the service .....	14
4.2. Designation of an OPA .....	14
4.3. Outage planning process .....	15
<b>5. Specific evolutions related to the Scheduling and Redispatching Processes</b>	<b>18</b>
5.1. Participation to the service .....	18
5.2. Designation of a SA .....	18
5.3. Scheduling process.....	19
5.4. Return to daily schedule process.....	21
5.5. Must run and may-not-run processes .....	28
5.6. Redispatching process.....	28
<b>6. Evolutions related to Congestion Management .....</b>	<b>41</b>
<b>6.1. Congestion Risk Indicator (CRI) .....</b>	<b>41</b>
6.1.1. Identification of electrical zone subject to CRI level .....	42
6.1.2. Determination of the CRI levels .....	43
<b>6.2. Other modifications to the Rules for Coordination and Congestion Management</b>	<b>46</b>

## 1. Practical information

This note aims to contextualize the documents that are submitted for public consultation by Elia.

At the end of the public consultation, all non-confidential comments will be made public on Elia's website, with an explanation of how Elia responded to these remarks or the reasons why they were not considered. Elia will respect the request for confidentiality and/or anonymity of respondents.

Comments concerning items outside the scope of the documents will not be considered by Elia.

The non-confidential documents submitted for consultation can be consulted on the Elia website.

The official public consultation starting with the documents subject to the public consultation being available in Dutch and French, lasts one month. Reactions must be sent using the online form available on the Elia website and no later than the deadline mentioned on the website.

Questions relative to the consultation can be sent to the following email address: [consultations@elia.be](mailto:consultations@elia.be).

## 2. Introduction

In the framework of the iCAROS<sup>1</sup> project, Elia intends to develop efficient and modern processes for the coordination of system relevant assets of grid users and for congestion management in a fast evolving electricity market in order to ensure grid security and compliancy with the applicable legislation (in particular with the requirements from the European regulation System Operation Guidelines – SOGL<sup>2</sup> and of the national regulation Code of Conduct). These processes are necessary for a safe management of the grid by contributing to the mitigation of congestions on the grid, the follow-up of the availability of ancillary services, the monitoring of the availability of power production means to satisfy the demand and the safeguarding of the operational security. In particular, the evolutions foreseen in the iCAROS project concern the following processes:

1. The **Outage planning** process ensured by the **Outage Planning Agent (OPA)** pursuant to articles 92 of the SOGL and 125 and 126 of the Code of Conduct. This process corresponds to the provision of availability plans necessary for the efficient coordination of system relevant assets of grid users and the planning of outages of Elia grid assets.
2. The **Scheduling** process ensured by the **Scheduling Agent (SA)** pursuant to articles 46 of the SOGL and 128 and 129 of the Code of Conduct. This process concerns the provision of active power schedules from day-ahead necessary for the coordination of system relevant assets of grid users and provides a necessary input for the assessment of congestion risks on the grid.
3. The **Redispatching** process (costly remedial actions) ensured by the **Scheduling Agent (SA)** pursuant to articles 130 and 131 of the Code of Conduct. This process concerns the provision and the activation of flexibility (active power upwards and downwards) offered by the SA as a means to solve operational security issues on the grid.
4. **The Congestion management process ensured by Elia pursuant to SOGL and CACM<sup>3</sup> requirements.** The introduction of a new **Congestion Risk Indicator** allowing to better represent the congestion risk in the different Belgian electrical zones contributes to the improvement of this process.

---

<sup>1</sup> iCAROS = integrated Coordination of Assets for Redispatching and Operational Security

<sup>2</sup> SOGL: Commission Regulation (EU) 2017/1485 of 2 August 2017 establishing a guideline on electricity transmission system operation entered into force on 14 September 2017.

<sup>3</sup> CACM: Regulation (EU) 2015/1222 establishing a guideline on capacity allocation and Congestion management

The evolutions of these processes were first described in three design notes<sup>4</sup> published and consulted in 2017. Following discussions and agreements with market parties, the implementation of the iCAROS design has been split in different phases reflecting the operational prioritization. The first phase (topic of the current public consultation) ensures the inclusion of all features required to allow a split of mFRR free bids and redispatching bids while ensuring operational excellence. The initial planning and content of the next phase of the iCAROS project (phase 2) is also detailed in a separate document that is also part of this public consultation and for which comments of market parties regarding the feasibility of the timeline and content are collected. After the setting of the scope of the first phase, aligned with market parties, the focus was on the design, relevant for this first phase, which was fine-tuned during several fine-tuning workshops between Elia and the market parties. An overview of the fine-tuned iCAROS design for this first phase is available on the Elia website<sup>5</sup>.

This explanatory document accompanies the public consultation of the updated versions of the Terms and Conditions for the Outage Planning Agent (T&C OPA), the Terms and Conditions for the Scheduling Agent (T&C SA) and the Rules for the Coordination and Congestion Management. Furthermore, this document intends to describe the evolutions, foreseen in phase 1 of the iCAROS implementation project, that are integrated in the new version of the beforementioned documents (and not the full design that will be implemented when all phases of iCAROS implementation project will have been completed). In addition to the present introduction, this note is composed of four other sections:

- Section 3 describes some general evolutions introduced in the phase 1 of the iCAROS implementation project
- Section 4 focuses on the evolutions in phase 1 related to the outage planning process that impact the new version of the T&C OPA
- Section 5 focuses on the evolutions in phase 1 related to the scheduling and redispatching processes that impact the new version of the T&C SA

---

<sup>4</sup> Available on the Elia website :

- for scheduling and redispatching: <https://www.elia.be/-/media/project/elia/elia-site/electricity-market-and-system---document-library/outage-planning-and-scheduling-agents/2018/2018-design-note-icaros-future-scheduling--redispatching.pdf>
- For outage planning: <https://www.elia.be/-/media/project/elia/elia-site/electricity-market-and-system---document-library/outage-planning-and-scheduling-agents/2018/2018-design-note-icaros-future-outage-planning.pdf>
- For Congestion Risk Indicator: <https://www.elia.be/-/media/project/elia/elia-site/electricity-market-and-system---document-library/congestion-management-and-redispatching/2018/2018-design-note-icaros-future-congestion-risk-indicator.pdf>

<sup>5</sup> <https://www.elia.be/en/users-group/wg-balancing/task-force-icaros/20230208-meeting>

- Section 6 explains the main modifications in phase 1 brought to the Rules for the Coordination and Congestion Management

### 3. General evolutions introduced by iCAROS design in phase 1

In phase 1 of the implementation project iCAROS, some new data concepts are introduced that are applicable for outage planning, scheduling and redispatching processes. These new data concepts are described below. The data concept of “system relevant assets for grid users” was translated to different sub-concepts for the processes in scope of iCAROS phase 1 in order to ensure the exchange of relevant and high quality data for the processes in scope while reflecting operational reality at the side of the service provider.

#### 3.1. New terminology introduced by iCAROS design

The iCAROS design introduces some new data concepts and a specific terminology applicable for the outage planning, scheduling and redispatching processes that is in line with the target design. This terminology is particularly important to define the level at which the information provided by the OPA and the SA needs to be exchanged. This specific terminology is used in the consulted T&C OPA and T&C SA.

##### Technical Units (TU)

A technical unit is a device or aggregation of devices connected directly or indirectly to the synchronous electrical network that produces and/or consumes electricity.

A technical unit can be:

- A power unit (PU)
- A demand unit (DU)

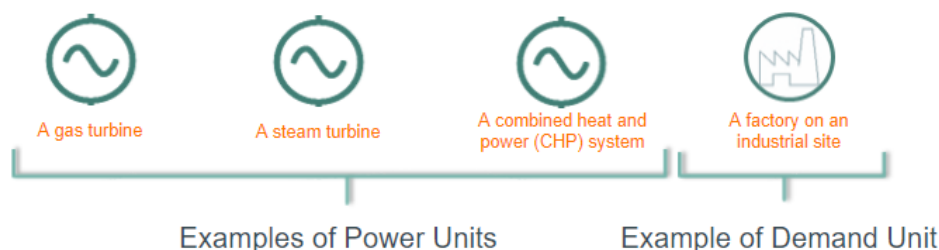

##### Technical Facility (TF)

A technical Facility is a complete set of technical unit(s) which are operationally linked and which, combined together in one or several operating modes, can consume or generate electricity on its own.

A technical facility can be a:

- Synchronous Power Generating Module (sPGM)



- Power Park Module (PPM) **per primary energy source**, i.e. the aggregation of all the components of the Power Park Module (as defined in NC RfG<sup>6</sup>) but contrary to the notion of PPM from the RfG, Elia introduces the notion of **PPM per primary energy source**. This means that if different PPMs are connected behind the same access point and use different primary energy source (e.g. one wind power park and one solar power park), two different PPMs per primary energy source are defined behind this access point.
- Demand Facility (DF)

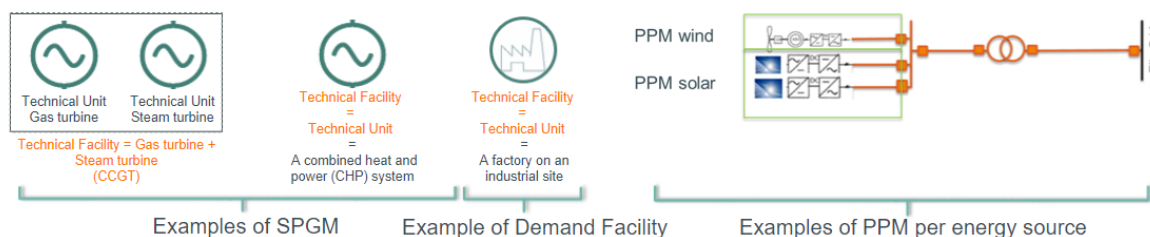

The technical facilities that have some energy limitations (the Energy Storage Devices (ESD) such as batteries or pump-hydro storage) are considered as either sPGM or PPM with Limited Energy Reservoir (LER). The presence of a LER is to be indicated in the technical characteristics of the technical facility in the relevant annex of the SA and OPA contract<sup>7</sup>.

The technical facility is the level at which the outage planning, scheduling and redispatching **obligations** are defined. For example, a technical facility (sPGM) with a maximum installed power of 40 MW, which is composed of two technical units with a maximum power of 20 MW, is obliged to participate to these services as the obligation is at the level of the technical facility which has a maximum installed power higher than 25 MW (see sections 4.1 and 5.1 for the description of the participation to these services)

### Operating Mode (OM)

An operating mode is any subset of technical units, being part of the same technical facility, that can generate or consume electricity on its own.

<sup>6</sup> RfG: The Commission Regulation (EU) 2016/631 of 14 April 2016 establishing a network code on requirements for grid connection of generators;

<sup>7</sup> The information concerning the presence of a LER is temporary collected in the SA contract until the same data is collected through the upcoming reviewed Connection Contract.





The operating mode concept is mainly introduced to allow the SA to accurately represent the **actual way of operating** of a technical facility when providing redispatching (RD) bids. The SA and Elia (KAM energy) have to agree on the list of operating modes available for a technical facility. If an operating mode contains more than one technical unit, the SA needs to provide a distribution key in the SA contract that allows Elia to know the repartition of an increase/decrease of injection/offtake between the different technical units in case of a redispatching activation request on this operating mode.

### Delivery Point (DP)

The definition of a delivery point is: a point on an electricity grid or within the electrical facilities of a grid user, where a service is delivered. This point is associated with one or several metering(s) and/or measures, according to dispositions of the contract related to this service, which enable(s) ELIA to control and assess the delivery of the concerned service.

Elia introduces this concept to precisely define the point at which the schedules and the outage plans have to be provided. This concept also allows performing quality and coherency checks of data. The rules to define the delivery point are described in the OPA and SA contracts. An important rule is that the **delivery points related to a given technical facility/technical unit defined in the T&C OPA for the outage planning process have to be identical to the ones defined in the T&C SA for the scheduling and redispatching processes.**

### Examples

1. The figure below illustrates the situation of a **CCGT** (Combined Cycle Gas Turbine) which is a synchronous Power Generating Module composed of three technical units: two gas turbines and one steam turbine. Three delivery points are defined at the level of the TUs and correspond to the points at which the data (in this example: availability statuses) need to be delivered as shown in the figure below.

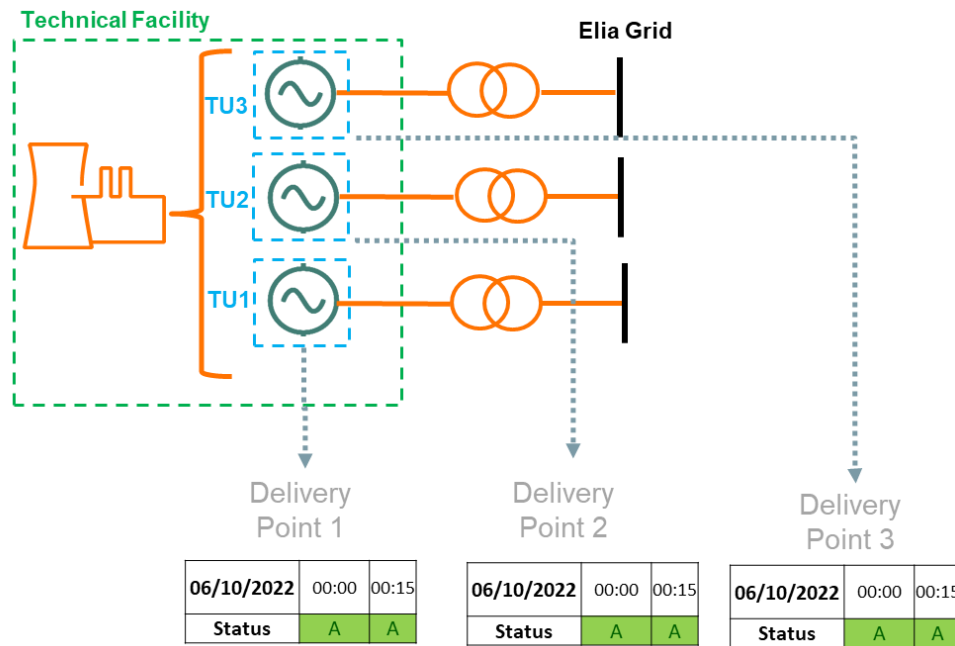

2. The figure below illustrates the case of a **wind park** which is a Power Park Module (PPM) whose primary energy source is wind. The delivery point for the provision of the availability statuses is defined at the level of the technical unit (which is by default also the technical facility as it is a PPM)

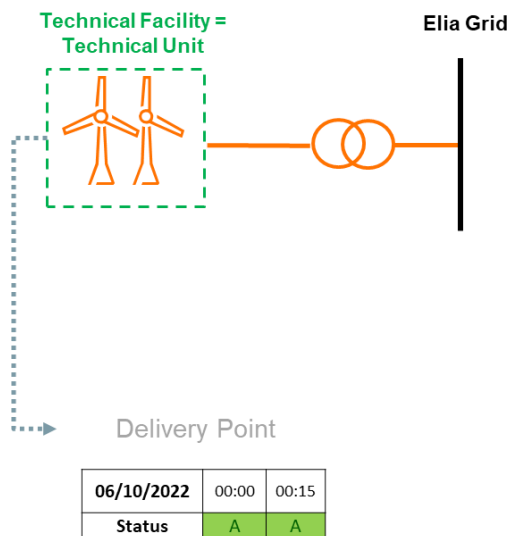

3. The figure below illustrates the case of a **wind park** which is a Power Park Module (PPM) whose primary energy source is wind and a **solar park** which is a PPM whose primary energy source is the sun. Both PPMs are **connected behind the same access point to the Elia Grid**. In this case, two different technical facilities are defined as the wind park and the solar park have different primary energy sources. A delivery point for the provision of the availability statuses is defined separately for each technical facility at the level of the technical unit.

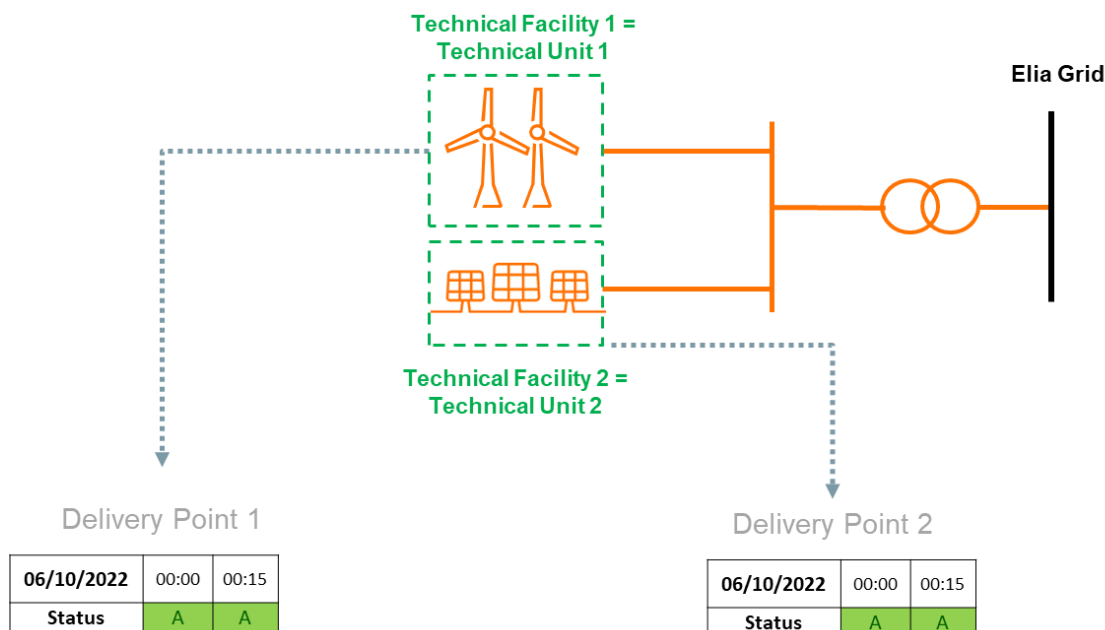

### 3.2. Coordinability of Technical Facilities

The iCAROS design also brings some changes to the concept of coordinability of a technical facility. The notion of “coordinability level” is introduced and is defined as: the ability or inability of a technical facility to modify its injection (or offtake) on the ELIA Grid, upon request by ELIA.

The main modifications compared to the existing definition of coordinability is that:

- The coordinability level is defined at the **level of the technical facility**. All technical units and operating modes related to a technical facility inherit from its coordinability level.
- Two levels of coordinability are defined:
  - **Coordinable (C)** that corresponds to the ability to modify the injection (and/or offtake) on the ELIA Grid, upon request by ELIA
  - **Not Coordinable (NC)** that corresponds to the inability to modify the injection (or offtake) on the ELIA Grid, upon request by ELIA.
- The coordinability level is defined **per direction** i.e. two coordinability levels are defined for a technical facility:
  - Coordinable/Not coordinable in the **upward direction** (i.e. the ability to increase the injection of active power or reduce the offtake of active power)
  - Coordinable/Not coordinable in the **downward direction** (i.e. the ability to reduce the injection of active power or increase the offtake of active power)

To allow defining clearly and unequivocally the coordinability of a technical facility, the existing concept of “Limited Coordinable (LC) unit” is not used anymore. This concept is not necessary as possible limitations of the coordinability of a technical facility are managed differently in iCAROS design:

- The limitation in terms of power flow direction is considered via the association of a direction to the coordinability level (the coordinability can be different in upward and downward direction)
- The limitation in terms of ramping (up or down) necessary for a technical facility to modify its injection/offtake at the request of Elia is considered separately in the characteristics of explicit redispatching bids provided by the SA as explained in the Section 5.6.

Some examples of coordinability levels for different types of technical facilities are shown in the table below. The coordinability level of a technical facility is always determined based on a discussion between the SA and Elia (KAM Energy).

Type of Technical Facility	Direction	Coordinability Level
<b>Gas Turbine</b>	Upward	C
	Downward	C
<b>Wind power park</b>	Upward	NC
	Downward	C

The coordinability levels are mainly used to assess if the delivery points related to a technical facility are eligible for:

- The data completeness and consistency control as explained in section 3.3
- The application of a return to schedule command as explained in section 5.4
- The provision of redispatching bids as explained in section 5.5

### 3.3. Data completeness and consistency control of exchanged data

In the iCAROS design, Elia emphasizes the importance of acquiring good quality and complete and consistent data from the different service providers when it is related to the same technical facility.

As the OPA and the SA can be different parties, Elia introduces the consistency controls to ensure that the data provided by the OPA and the SA do not lead to inconsistencies that could endanger the security of the grid as these data are used as inputs for the grid security

analyses. The different data whose consistency is verified at delivery point level are described in the table below.

Data consistency control between				Reason
Data 1	from	Data 2	from	
Availability status	OPA	Schedule	SA	<p>The availability status and maximum available power provided by the OPA has to be consistent with the daily schedule provided by the SA i.e.</p> <ul style="list-style-type: none"> <li>• a non-zero daily schedule cannot be provided while the status of the technical unit is set to unavailable by the OPA</li> <li>• the daily schedule must be lower or equal to the maximum available power in case the availability status is set to available</li> </ul>
Availability status	OPA	RD bids	SA	<p>This control ensures that the submission of redispatching energy bids by the SA is consistent with the availability status given by the OPA i.e.</p> <ul style="list-style-type: none"> <li>• At least one RD energy bid is submitted if the availability status is set to available</li> <li>• No RD energy bid is submitted if the availability status is set to unavailable</li> </ul> <p>This consistency controls is performed taking into account the coordinability level of the delivery point.</p>

In addition to these consistency controls, a data completeness control is introduced in the Scheduling Agent contract to verify that the first version of the daily schedule is well provided by the SA at the required timing in D-1 as explained in section 5.3. The provision of the daily schedule at the required timing is indeed essential to ensure grid security analyses executed in D-1.

The precise control, conditions for the control and consequences of inconsistencies or lack of completeness are described in the T&C OPA and T&C SA.

## 4. Specific evolutions related to the Outage planning process

### 4.1. Participation to the service

The table below describes the participation of different types of technical facilities to the outage planning process for the phase 1 of iCAROS implementation project.

Type of technical facilities	Participation to outage planning
sPGM – PPM connected to Elia grid or to a CDS grid connected to Elia grid with a maximum power larger than or equal to 25 MW	Mandatory
sPGM – PPM connected to Elia grid or to a CDS grid connected to Elia grid with a maximum power lower than 25 MW	Voluntary or application of default rules as defined in the whereas 21 of the T&C OPA
sPGM - PPM connected to Distribution Grid	Voluntary
Demand facilities	Application of default rules as defined in the whereas 22 of the T&C OPA

For the reasons explained in the section 2 of this note, the obligation to participate to the outage planning process in iCAROS phase 1 is limited to the sPGM and PPM with a maximum power larger than or equal to 25 MW and connected to the Elia grid or a CDS grid connected to the Elia grid. The replacement of default rules for an actual data exchange for the other types of technical facilities is in the scope of the next phases of the iCAROS implementation project.

### 4.2. Designation of an OPA

In the framework of phase 1 of the iCAROS project, and conform to article 243 of the Code of Conduct and in line with article 126 2° of the Code of Conduct, the responsibility of OPA is **by default** taken up by the BRP in charge of the access point<sup>8</sup> to which the technical facility is connected. This approach was agreed with market parties to gradually introduce the new

---

<sup>8</sup> Or the BRP in charge of the delivery point below the access point in case a multiple BRPs solution is defined behind the access point according to the modalities that will be described in the upcoming reviewed access contract and BRP contract.

roles and responsibilities foreseen for OPA and SA in the iCAROS design as well as to provide a learning period before the full split of the SA/OPA and BRP roles.

In case a grid user of a technical facility is willing to deviate from this by-default designation, the T&C OPA allows the grid user to become OPA or to designate a third party (other than the BRP) as OPA for the technical facility (and as such all delivery points linked to this technical facility). In both cases, an opt-out arrangement between the OPA and the BRP needs to be provided to Elia to ensure all parties acknowledge the transfer of responsibility for the outage planning process. For clarity, this option is only relevant if the **grid user voluntarily chooses** to deviate from the default rule (i.e. the OPA is the BRP as stated above) that applies in all the other situations.

### 4.3. Outage planning process

In accordance with article 92 of the SOGL, the notion of “availability status” is introduced in the outage planning process described in the T&C OPA. Consequently, the following availability statuses as defined in the SOGL are defined in the T&C OPA:

Available (A)	Unavailable (U)	Testing (T)
<p>The Delivery Point to which a Technical Unit is associated is capable of and ready for injecting or offtaking active power regardless of whether it is or it is not in operation</p>	<p>The Delivery Point to which a Technical Unit is associated is not capable of or ready for injecting or offtaking active power due to a full planned unavailability</p>	<p>The capability of the relevant Delivery Point to which a Technical Unit is associated, for injecting or offtaking active power is being tested</p>

As part of the phasing of the iCAROS implementation project, the **current procedures** related to the exchange of information concerning the availability of technical units are maintained in iCAROS phase 1 **until Thursday W-1 18:00 after the end of the ready-to-run procedure** i.e. the content of the Listed, Revision, Stand-by and Ready-to-run procedures have not been modified in this version of the T&C OPA. However, an alignment of the availability statuses with the SOGL terminology is made in the T&C OPA meaning that the statuses Available, Unavailable and Testing are used for all procedures throughout the T&C OPA. An implementation code has been each time added to link these new statuses with the existing statuses that are still used in the operational information exchange process (i.e. the actual operational data exchange via the Elia “Topaz” tool<sup>9</sup>). As an example: for the

<sup>9</sup> As the current procedures until the end of the ready-to-run procedure have not been modified, all the data in the templates to exchange information with Elia (as described in Annex 4 of the OPA contract) still need to be provided by the OPA (including information such as the Peak Forecast Load in the template of the Stand-by procedure and the Off-peak Forecast Load in the template of the Ready-to-Run procedure). An update of these procedures and related data exchange is foreseen in iCAROS phase 2.



Revision procedure, if the OPA needs to indicate that its delivery point is Available, it has to use the existing code “NRV (Not Revision)” in the information exchange process.

After the Ready-to-run procedure, the **provision of an availability plan by the OPA is required**. This availability plan consists in providing to Elia, on a quarter-hour basis for a given delivery point:

- An availability status corresponding to one of the three statuses described above or a Forced Outage status under the conditions described below in this note;
- A corresponding maximum available power.

The evolution of the outage planning process in iCAROS phase 1 can be summarized in the following figure:

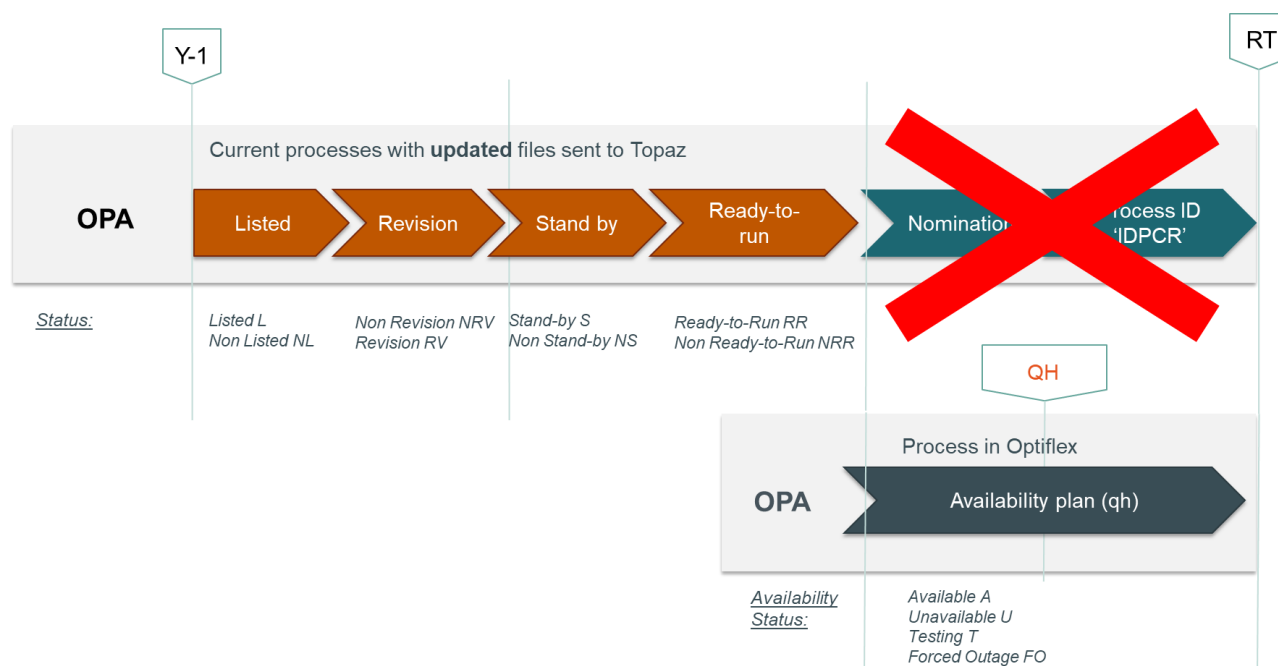

### Generation and update of availability plans

To ensure the transition between the existing procedures and the new Availability Plan, a quarter-hourly availability plan is **automatically generated** by Elia from the information provided through the Ready-to-run procedure by the OPA. The status coming from the Ready-to-run procedure is automatically translated to a “A” or “U” status with a corresponding maximum available power for all quarter-hours according to the conversion table described in the T&C OPA.

**Example:**

↪ Automatic translation ↩

Procedure :	READY-TO-RUN
Period of execution :	2022W39
OPA :	OPA_NAME
File Type :	PREVISION
OPA Version :	1
ISO :	
ISO Version :	

Monday	DD/MM/YYYY	Off-Peak Forecast Load (MW): 100.00				
EAN CODE DELIVERY POINT	FRIENDLY NAME	OPA		TSO		
		Status (V1)	Power Injection (MW)	Status (V1)	Planned Outage (MW)	Planned Outage (MW)
18Dgt_EAN_Wind Park A	Wind Park A	RR	50.0			
18Dgt_EAN_CCGT B GT1	CCGT B GT1	RR	75.0			
18Dgt_EAN_CCGT B GT2	CCGT B GT2	NRR	75.0			
18Dgt_EAN_CCGT B ST1	CCGT B ST1	RR	50.0			

06/10/2022		00:00	00:15	00:30	00:45	01:00
Wind Park A	Status	A	A	A	A	A
	$P_{max,avail}$	75	75	75	75	75
CCGT B GT1	Status	A	A	A	A	A
	$P_{max,avail}$	85	85	85	85	85
CCGT B GT2	Status	U	U	U	U	U
	$P_{max,avail}$	0	0	0	0	0
CCGT B ST	Status	A	A	A	A	A
	$P_{max,avail}$	55	55	55	55	55

$P_{tech,max}$  from contractual data

After the automatic translation, the OPA must keep the availability plan up-to-date by modifying, if necessary, the availability status and/or the maximum available power for a given quarter hour according to the rules stated in the T&C OPA. In particular, in case the OPA is willing to indicate a **partial** planned unavailability for a delivery point, it has to submit a status “Available” with a maximum available power lower than the maximum power of the delivery point.

### Forced Outage process

In addition to the three statuses A, U and T, a specific Forced Outage (FO) status is defined to handle **unexpected partial or full unavailabilities** preventing a delivery point to inject/offtake active power in agreement with article 127 of the Code of Conduct. This status is also introduced to be compliant with transparency regulation (EU Regulation 543/2013) that requires a specific distinction between planned and unplanned unavailabilities when publishing information on the ENTSOe Transparency Platform. To ensure coherent processes and avoid parallel ways to communicate information (that would represent an additional complexity for market parties without any added value for the process), the existence of a specific status for unplanned unavailability is necessary. In case the OPA needs to indicate a partial forced outage of a delivery point, it has to submit a status “Forced Outage” with a maximum available power larger than 0 MW. The updates of availability plan due to a forced outage follow specific validation rules due to the unexpected nature of the event. These rules are described in the relevant section of the T&C OPA.

## 5. Specific evolutions related to the Scheduling and Redispatching Processes

### 5.1. Participation to the service

The table below describes the participation of different types of technical facilities to the scheduling and redispatching processes for the phase 1 of iCAROS.

Type of Technical Facilities	Participation to Scheduling and Redispatching
sPGM – PPM connected to Elia grid or to a CDS grid connected to Elia grid with a maximum power larger than or equal to 25 MW	Mandatory
sPGM – PPM connected to Elia grid or to a CDS grid connected to Elia grid with a maximum power lower than 25 MW	Voluntary or application of default rules as defined in the whereas 19 of the T&C SA
sPGM - PPM connected to Distribution Grid	Voluntary
Demand facilities	Exempted

For the reasons explained in the section 2 of this note, the obligation to participate to the scheduling and redispatching processes in iCAROS phase 1 is limited to the sPGM and PPM with a maximum power larger than or equal to 25 MW. The replacement of default rules for an actual data exchange for the other types of technical facilities is in the scope of the next implementation phases of iCAROS project.

### 5.2. Designation of a SA

In the framework of phase 1 of the iCAROS project, and conform to article 243 of the Code of Conduct and in line with article 131 §1 2° of the Code of Conduct, the responsibility of SA is taken up by the BRP in charge of the access point<sup>10</sup> to which the technical facility is connected. This approach was agreed with market parties to gradually introduce the new roles and responsibilities foreseen for OPA and SA in the iCAROS design as well as to provide a learning period before the full split of the SA/OPA and BRP roles.

<sup>10</sup> Or the BRP in charge of the delivery point below the access point in case a multiple BRPs solution is defined behind the access point according to the modalities that will be described in the upcoming reviewed access contract and BRP contract.

### 5.3. Scheduling process

The active power schedules are of key importance to Elia. They inform ELIA about the level of electricity production and/or consumption of technical units connected to the grid. Consequently, their impact on load flow calculations is examined during the grid security analysis. **ELIA uses the schedules received as an input:**

- in load flow calculations to analyze the system security and to detect potential operational security risks before real-time and the need for national and/or cross-border redispatching;
- in the CRI (Congestion Risk Indicator) level determination;
- for the calculation of cross-border capacities;
- for maintenance planning;
- for the assessment of the unavailability risk of ancillary services (e.g. the availability of active and reactive power reserves).

The scheduling process consists of **providing schedules of active power injection/offtake at the level of each delivery point** related to a technical facility having a scheduling obligation:

- One MW value is expected for each quarter-hour of a given day and has to correspond to the best estimation of the active power injection/offtake of the delivery point (note: for a battery, the average active power injection or offtake for a given quarter-hour needs to be indicated).
- Active power injection/offtake values below the technical minimum injection/offtake power of the delivery point (e.g. in the framework of a start up or shut down) also have to be indicated in the schedules.
- The schedule sent by the SA for a given delivery point is independent of the possible redispatching or balancing activations requested by Elia that include this delivery point i.e. the SA should not consider these activations in the schedule it provides to Elia. The impact of redispatching and balancing activations is internally considered for security analyses and settlement processes in Elia's system.
- The SA needs to use the following sign convention for the submitted schedules:
  - A positive value corresponds to an offtake of active power from the Elia grid
  - A negative value corresponds to an injection to the Elia grid

The timings related to the delivery of schedules are shown on the figure below:

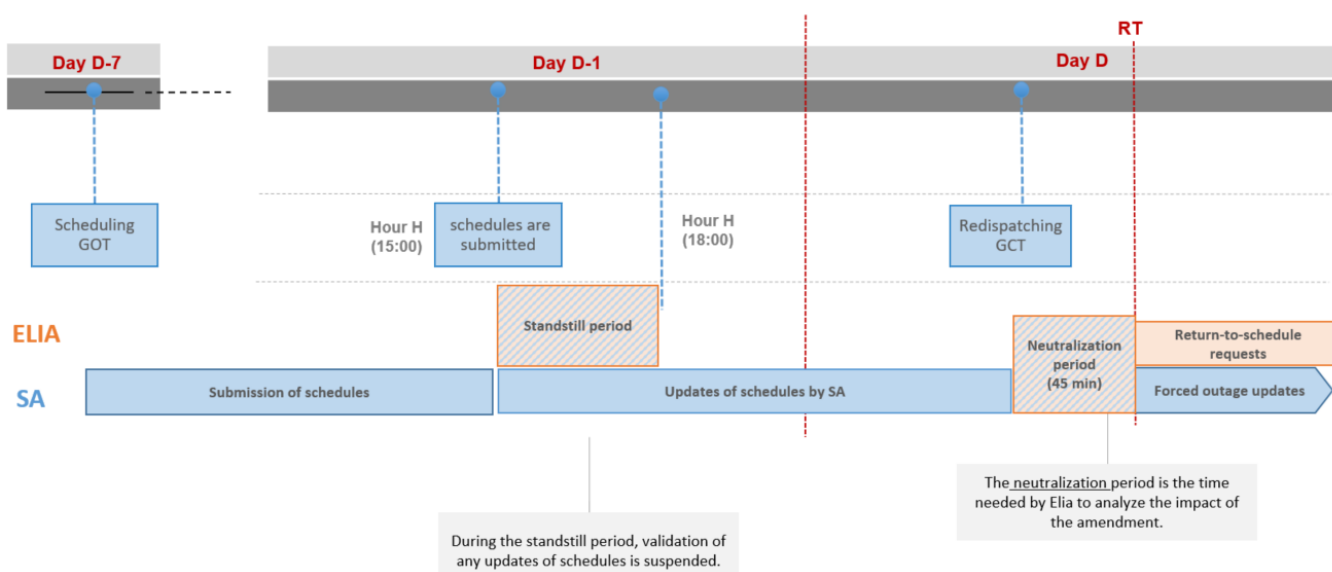

While the scheduling gate opening time (GOT) is on D-7, a first version of the daily schedule for day D is expected on D-1 15:00 at the latest. After the submission of the first version of the daily schedule, the SA must update its daily schedule when necessary so that the daily schedule always represents the best estimation of the expected active power injection/offtake. Just after the submission of the initial schedules, a **standstill period** is defined in which the validation of daily schedule updates is suspended<sup>11</sup>. This period allows Elia to freeze the input data for the creation of the first individual grid model (IGM) of day D that is used as a basis for the grid security analysis on the national and European level. During this standstill period, Elia creates the IGM based on the provided daily schedules, cross-border nomination, and best estimates (of load, renewable generation, and thermal limits of grid elements including dynamic line rating) and perform a security analysis. Based on the results of this analysis, Elia takes some first decisions related to a.o. conditional outages and remedial actions to be taken.

With the go-live of the first phase of the iCAROS implementation project, Elia introduces the **freedom of dispatch** concept meaning that the schedules can be updated without Elia's validation related to congestion risks until Redispatching Gate Closure Time (RD GCT corresponding to 45 minutes before the start of a given quarter-hour), with some exceptions as specified later on. This means that the SA can profit from all market opportunities before RD GCT, even if a risk of congestion was identified in a certain electrical zone. The neutralization period after RD GCT is necessary to leave enough time for Elia to perform security analyses to detect congestions based on the last available schedules and to assess the need of remedial actions to solve these congestions as well as apply these remedial actions (e.g. request a redispatching energy bid activation) if necessary.

<sup>11</sup> In exceptional situations such as a delay in the single day-ahead market coupling, the standstill period could start later to allow market parties to provide their daily schedules. In such situation the delayed deadline will be communicated to market parties and the control related to data completeness will be applied considering the delayed deadline.

Three exceptions to freedom of dispatch, in which daily schedule updates for a particular delivery point are rejected or need a manual validation from Elia, exist:

- In case a daily schedule update of a delivery point belonging to a technical facility is in the opposite direction of a previously requested redispatching energy bid activation including this delivery point as this could reduce or even cancel the effect of the redispatching activation that is necessary to solve a congestion on the grid;
- In case a daily schedule update of a delivery point belonging to a technical facility is in the opposite direction of a previously agreed must-run or may-not-run on a delivery point of a technical facility as this could cancel the effect of the requested schedule reservation;
- In case of a sea storm, and as foreseen in article 134 of the Code of Conduct, in order to perform the cut-in coordination of the offshore wind power parks after the storm and ensure that the return of the power production does not create operational security risk for the grid.

#### 5.4. Return to daily schedule process

Pursuant to article 133 of the Code of Conduct, and as the last validated daily schedule at RD GCT is expected to be firm, **Elia can enforce the SA to return to its daily schedule in real-time**. Elia will only enforce the SA to return to its daily schedule when this is deemed necessary for the grid security i.e. if the deviation of the daily schedule causes or aggravates a congestion risk. This command will be requested for all delivery points in a specific electrical zone, in accordance with the CRI level (as described in Section 6.1) defined in this zone. The SA of the delivery point **only needs to react if its active power injection/offtake is deviating from the daily schedule in the direction of the medium or high CRI defined in the zone** (note: the authorized boundaries in which the delivery point is allowed to operate is indicated in the return to schedule request message)

A return to schedule request:

- Applies instantly to the quarter-hour in which the request was sent by Elia and until the end of the third quarter-hour after the request. The return to schedule is requested most of the time at the beginning of the first quarter-hour of an hour for which a high or medium CRI was defined beforehand so that the full hour is covered by the return to schedule. In case of an unexpected operational security issue, the return to schedule can also be requested later than the first quarter-hour of an hour for which a low CRI was previously defined. In this case, the CRI level of this hour (and possibly next hours) is directly adapted before the return to schedule is requested and the return to schedule request is only valid from the quarter-hour of the request until the end of the last quarter-hour of this hour;
- Is only sent to delivery points of technical facilities which are coordinable in the direction allowing a return to schedule

Two examples of possible return to schedule commands are illustrated below, considering the following electrical zone containing three technical facilities each with one delivery point (in the example technical facility = technical unit = delivery point) :

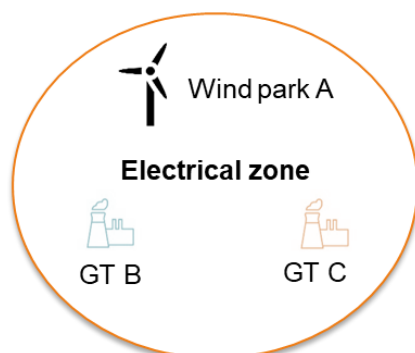

Type of Technical Facility	Direction	Coordinability Level
Gas turbines (GT) B and C	Upward	C
	Downward	C
Wind park A	Upward	NC
	Downward	C

- An upward **return to schedule** is requested in the electrical zone while a **CRI medium or high in the downward direction** is defined in this zone. As illustrated on the figure below, the following reaction is expected from the technical facilities:
  - The GT B that was deviating from its schedule in the direction of the CRI needs to realign its power injection with its schedule (or inject more power than its scheduled injection)
  - The GT C that was deviating from its schedule in the opposite direction of the CRI does not need to react to the request
  - The wind park A, that was deviating from its schedule in the direction of the CRI, does not receive the return to schedule request as it is not coordinable in the upward direction



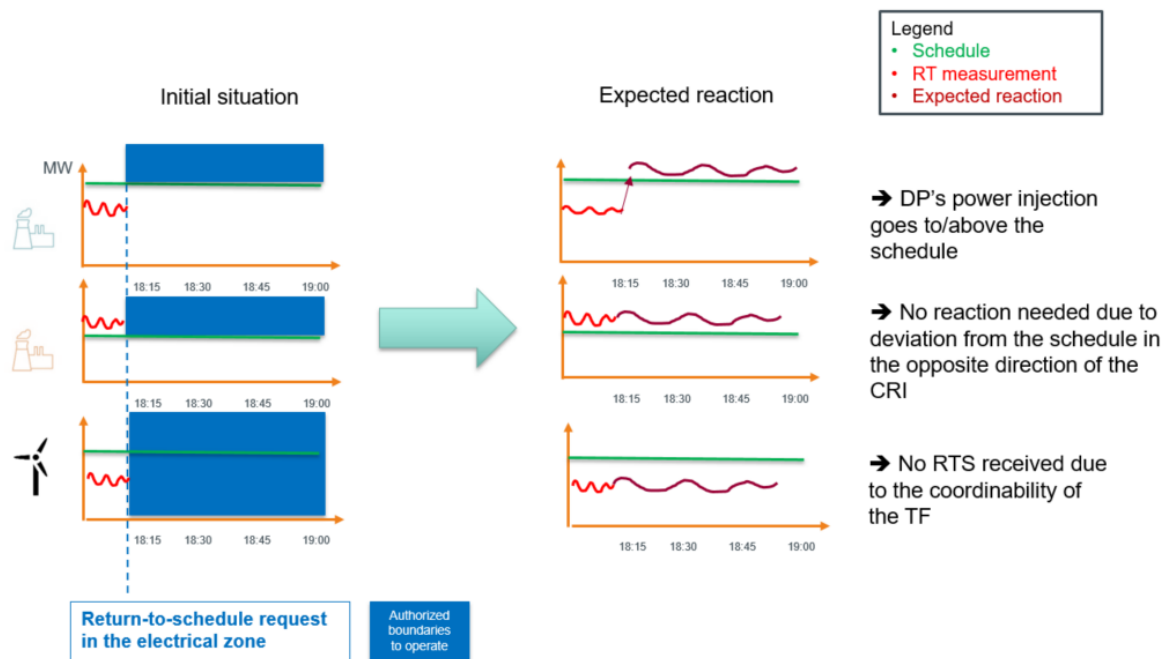

- A downward **return to schedule** is requested in the electrical zone while a **CRI medium or high in the upward direction** is defined in this zone. As illustrated on the figure below, the following reaction is expected from the technical facilities:
  - The GT B that was deviating from its schedule in the opposite direction of the CRI does not need to react to the request
  - The GT C that was deviating from its schedule in the direction of the CRI needs to realign its power injection with its schedule (or inject less power than its scheduled injection)
  - The wind park A, that was deviating from its schedule in the direction of the CRI needs to realign its power injection with its schedule (or inject less power than its scheduled injection)

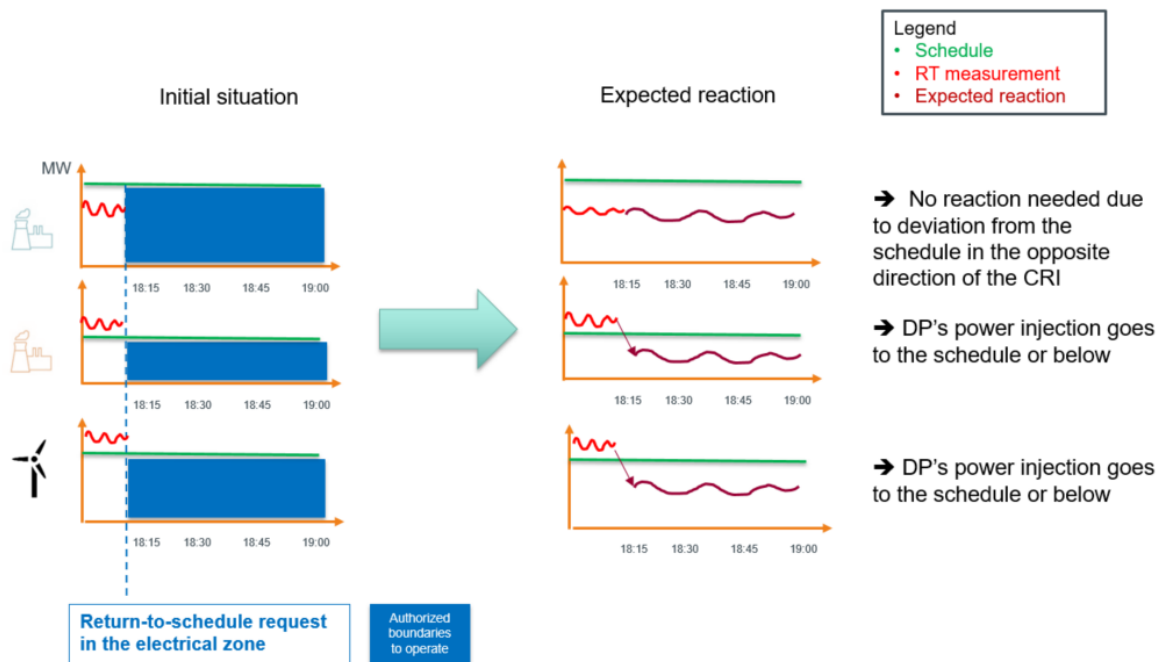

## Return to daily schedule control and settlement

Each return to daily schedule request is subject to an ex-post return to daily schedule control to ensure that the SA correctly executed the command. This control consists of verifying if the actual active power injection/offtake of the delivery point (based on measurements) does not deviate from the daily schedule of that delivery point in the direction of the medium or high CRI, defined in the zone. This control is performed for all quarter-hours for which the return to daily schedule request is applicable. In case the return to schedule is not requested during the first quarter-hour of an hour (due to unexpected operational security issue), the control is only applied from the quarter-hour of the return to schedule request until the end of the last quarter-hour of this hour.

In order to respect the return to daily schedule it may be necessary for a technical unit linked to a delivery point to increase/decrease its active power output (ramping up or ramping down), as such Elia considers a specific tolerance in the control for the quarter-hour following the quarter-hour in which the request was sent. This tolerance corresponds to 50% of the deviation from the daily schedule during the quarter-hour in which the return to schedule request was sent by Elia. Elia also considers a general tolerance for all quarter-hours<sup>12</sup> for which the return to daily schedule request is applicable to take precision errors around the schedule into account. This tolerance is equal to the maximum value between two terms<sup>13</sup>:

<sup>12</sup> For the first quarter-hour after the request, the highest value between the general tolerance and the specific tolerance is considered for the control.

<sup>13</sup> This tolerance is only applicable in the framework of the phase 1 of iCAROS and shall be revised for the next phases of iCAROS.

- 2% of the maximum power that can be injected or taken off by the delivery point. In case the delivery point can inject and consume active power, the highest value between the maximum power in injection and in offtake is used.
- 2 MW

In case a balancing activation is requested on the same delivery point in the direction of the CRI (e.g. a scheduled mFRR activation involving a delivery point located in a zone with a medium CRI which is requested before the return to daily schedule command is requested), Elia shall consider the balancing activation in the return to daily schedule control to avoid penalizing the SA.

Some examples of compliant and non-compliant return to schedule are illustrated below for a delivery point injecting active power whose injection deviates from its daily schedule in the direction of the CRI (considered as high in the downward direction meaning that the DP cannot inject less active power than its daily schedule) at the moment of the request<sup>14</sup>.

- Compliant return to daily schedule as the deviation from the daily schedule in QH1 is lower than 50% of the deviation identified in QH0 (i.e. 50% of the difference between the daily schedule and the actual injection in QH0) and the actual injection in QH2 and QH3 is equal or higher than the schedule.

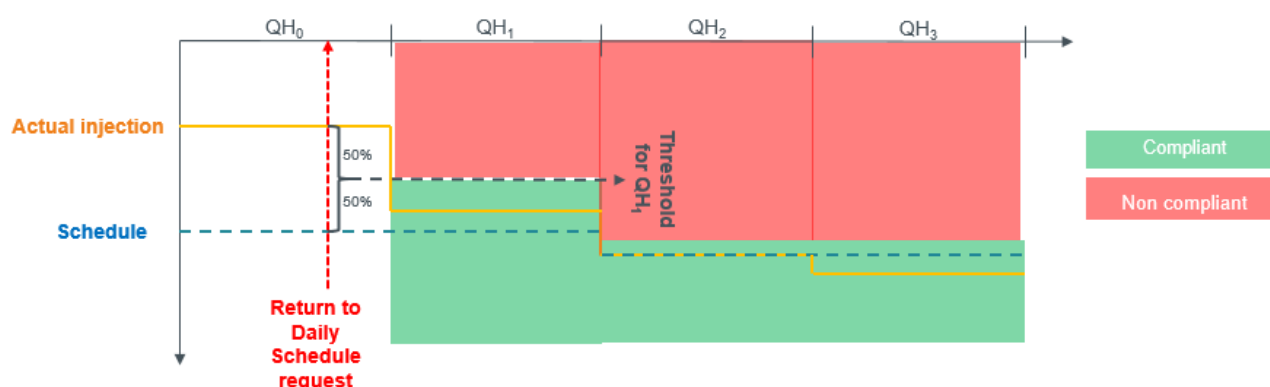

- Non-compliant return to daily schedule as the actual injection is lower than the schedule in QH2 (the second quarter-hour following the quarter-hour of the request) even considering the tolerance

<sup>14</sup> Using the sign convention defined previously (indicating injection as a negative value), an increase of injection corresponds to a more negative value on the figures

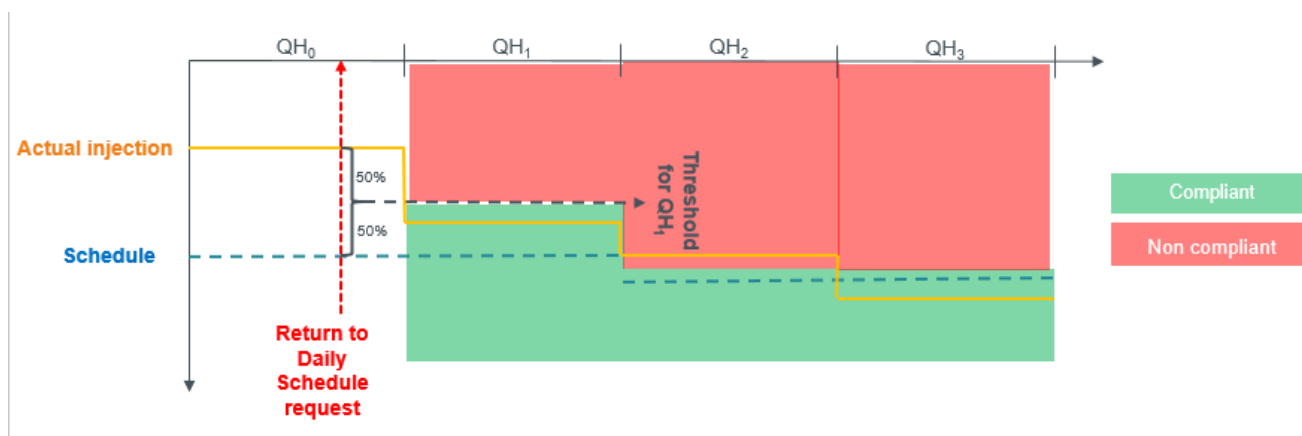

- Non-compliant return to daily schedule as the deviation from the schedule in QH1 is higher than 50% of the deviation from the daily schedule in QH0

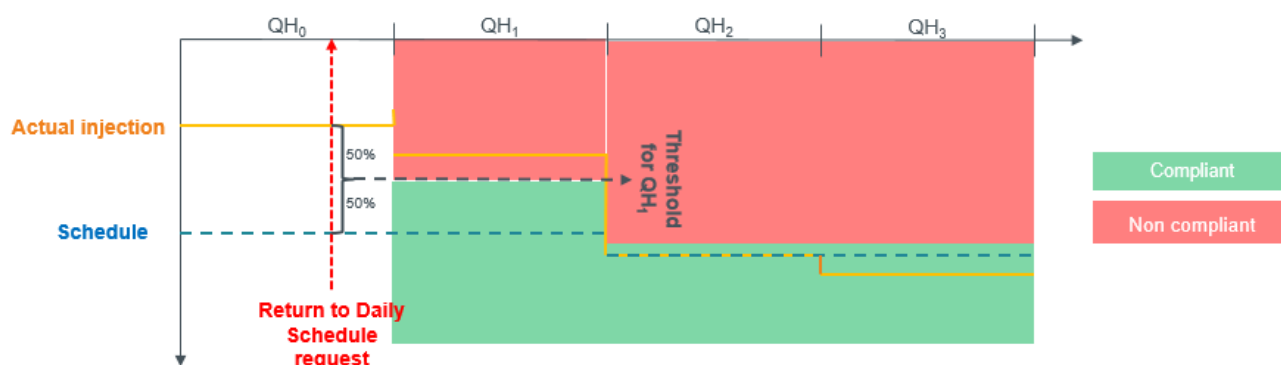

The return to daily schedule executed by a SA is considered as non-compliant when the conditions explained above are not satisfied **for at least one of the quarter-hours impacted by the return to schedule request.**

Each non-compliant return to schedule will lead to the application of a settlement. The settlement is based on the energy corresponding to the difference between the daily schedule and the actual active power injection/offtake in the direction of the medium or high CRI level for all the quarter-hours of the return to schedule and a settlement price.

The price applied per quarter-hour for the settlement corresponds to the highest absolute value of the two following options, for the concerned quarter hour:

- the imbalance price of the quarter-hour and
- the rolling average, of the last 6 complete Months day-ahead power auction market price, for Belgium, published by EPEX; preceding the month in which the return to schedule request was sent.

This price is set to incentivize SA's to effectively execute the request even if the value of the imbalance price would give an incentive to the BRP to keep deviating from the daily schedule. As highlighted at the beginning of this section, Elia needs to ensure that sufficient incentives

exist to perform the return to schedule requests as they are very critical for safeguarding the operational security. Some values of the average of the day-ahead power auction market price are shown for illustration-purpose in the table below:

Month of the Return to Schedule	Price (€/MWh)
Jul-22	200,93
Apr-22	206,13
Jan-22	150,79

An example of the application of the settlement is shown on the following figure. In this example, the RTS is considered as non-compliant due to a deviation from the schedule in the direction of the medium or high CRI (in downward direction) in QH2.

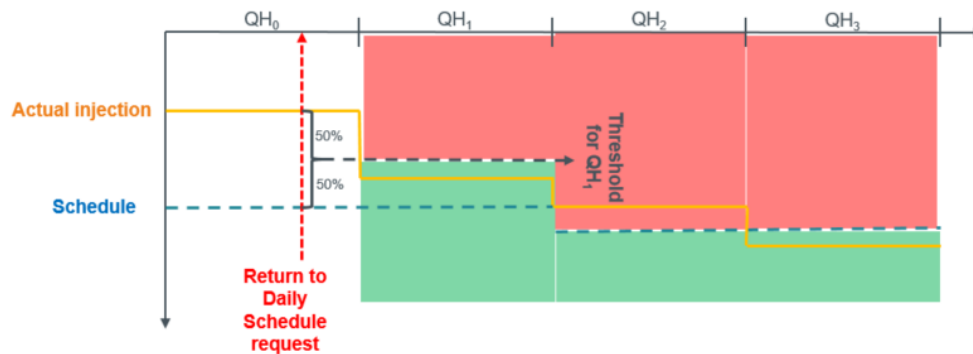

The energy corresponding to the (absolute value of the) difference between the daily schedule and the actual active power injection in the direction of the medium or high CRI level is then computed for all QHs of the RTS

Quarter-hour	Daily Schedule – actual injection  (MW) in direction of CRI	Energy corresponding to this difference (MWh)
QH0	60	15
QH1	20	5
QH2	10	2,5
QH3	0	0

Considering that the average of the day-ahead power auction market price is 200,93 €/MWh (price for July 2022 as indicated in the table above) and the following values of the imbalance price for the different quarter-hours, the settlement for each quarter-hour of the RTS amounts to:

Quarter-hour	Imbalance price (€/MWh)	Settlement (€)
QH0	150	/
QH1	150	5 x 200,93= 1004,25
QH2	250	2,5 x 250= 625
QH3	300	0

The total amount of the settlement in this examples amounts to 1629, 25 €

## 5.5. Must run and may-not-run processes

The must-run and may-not-run are processes allowing Elia to impose conditions on the scheduled active power injection or offtake of a technical unit with an availability status “A”. Requesting a must run or a may-not-run means that the SA needs to take these conditions into account when providing its initial daily schedule in D-1 and when providing later updates of this daily schedule in ID.

While must-run and may-not-run processes were initially described in the T&C OPA, the operational and financial conditions for requesting a must-run or a may-not-run are now part of the T&C SA as they impact the scheduling process and so fall within the scope of the responsibilities of the SA. Must-run and may-not-run can be requested by Elia at the latest 5 working days before the execution day so that the SA has the possibility to provide a financial offer for performing the request. In case of grid security risk, Elia can however request a must run or a may-not-run later than 5 working days before the execution day if an agreement is found with the SA.

## 5.6. Redispatching process

According to article 130 of the Code of Conduct, and as described in the Rules for Coordination and Congestion Management, Elia uses redispatching activations as a remedial action to ensure the operational security of the grid. In particular, redispatching activations are used for:

- National congestion management on the Elia grid
- Cross-border redispatching and countertrading in the context of cross-border congestion management processes

- Less frequently for some exceptional procedures such as the procedure in case of exhausted FRR and escalation procedure<sup>15</sup>

The main changes related to the redispatching process in iCAROS phase 1 are summarized in the following table and detailed in the next sections:

		As is	iCAROS as from phase 1
<b>Redispatching Submission process</b>		<i>Implicit bidding</i>	<i>Explicit bidding</i>
<b>Remuneration</b>	DA redispatching	<i>Cost-based prices</i>	<i>Cost-based prices</i>
	ID redispatching	<i>Free prices</i>	
<b>Activation control</b>		/	<i>Based on the difference between the supplied energy and the requested energy</i>

### Submission of redispatching (RD) bids

iCAROS design foresees a transition from the current implicit bidding process in which Elia computes the available volume for redispatching (for units with a maximum power equal to or larger than 25 MW) to an explicit bidding process in which the SA has to provide the relevant data related to the costly redispatching means available at the delivery points managed by the SA (including at least the available volume and price), taking into account the capabilities of its technical units as well as the operating modes of these technical units. **This evolution gives the SA the possibility (and the responsibility) to provide the most accurate information concerning the capability of its technical units (considering the operating modes of these technical units) to provide costly redispatching means, respecting also the requirements of article 130 of the code of conduct.**

This evolution is also triggered by the fact that explicit bidding is a requirement for the mFRR product in order to be in line with the requirements related to the connection to the MARI platform (EU platform for mFRR). Today the same data exchange is used for RD bids and mFRR free bids based on the fact that although these are different flexibility products they both reflect a similar remaining flexibility linked to the same delivery points. As such, both

---

<sup>15</sup> These procedures are described in the Elia's LFC block operational agreement available on the Elia website: [https://www.elia.be/-/media/project/elia/elia-site/electricity-market-and-system/system-services/keeping-the-balance/20220715\\_lfcboa\\_v20220714\\_en\\_maindocument.pdf](https://www.elia.be/-/media/project/elia/elia-site/electricity-market-and-system/system-services/keeping-the-balance/20220715_lfcboa_v20220714_en_maindocument.pdf)



flexibility products, RD bids as well as mFRR free bids needed to evolve to explicit bidding at the same time in order to safeguard the possibility for Elia and the service providers to maintain coherency between the two flexibility products. Given that RD bids and mFRR free bids can be offered by different service providers in the target design, being implemented through the iCAROS implementation project, separate data flows for the two products need to be developed.

Process-wise, the SA needs to submit explicit RD energy bids (volumes and prices being only valid for redispatching energy bids) representing an operating mode in accordance with the requirements stated in the SA contract. Multiple parameters exist to ensure that the SA can, in the most accurate way, offer the available volume for redispatching on its delivery points linked to technical units. For coherency and simplification reasons, these parameters are mostly all aligned with the parameters defined for the mFRR product. Others are nevertheless specific for the redispatching such as:

- **Full Activation Time (FAT)** that allows bidding flexibility with an activation time longer than 12,5 min
- **Maximum Activation Time (MAT)** that allows bidding flexibility that can only be activated during a limited period of time due to energy limitations. The use of the MAT or another parameter to represent energy limitations is still subject to finalization depending on ongoing discussions with market parties in the framework of market facilitations features. Modifications of this parameter can be a consequence of these discussions and as such could lead to modifications in the SA contract reflecting the final agreement between market parties and Elia but the finality of the parameter being allowing bidding of flexibility taking into account energy limitations will be maintained.
- **Minimum Activation Time (MIT)** allowing bidding flexibility that needs to be activated during a minimum period of time for technical reasons (limited to start-up case)

These parameters are extensively described in the **Energy Bidding Manual** that provides the SA with the necessary information to submit RD bids.

**To ensure grid operational security in the context of the freedom of dispatch** (as explained in section 5.3), Elia needs to rely on up-to-date RD bids aligned with the last schedules provided. Indeed, up-to-date RD bids must always be at the disposal of Elia to solve a congestion induced by a schedule update. This has two impacts on the scheduling and redispatching obligations:

1. The SA must update its RD bids in line with the flexibility available on the DPs that are part of these RD bids. RD bids updates are at least expected each time a new schedule (of a DP contained in the RD bids) is submitted.
2. In order not to put operational security at risk, Elia is allowed to revert the automatic validation of a schedule update of a given DP in case the RD bids related to the same delivery point are not updated in due time (15 min) after the update of the schedule (exemption update of RD bids after activation done by Elia). This process is only applied if an operational risk is identified and the use of these RD bids is necessary to solve the issue.

## Activation of RD bids

Two kinds of activation of a RD bid can be requested by Elia:

- **Scheduled activation:** these redispatching activations are usually requested **ahead** of real-time (e.g. one to two hours before real-time and always respecting the indicated FAT).
- **Direct activation**<sup>16</sup>: these redispatching activations are requested **in real-time** and **need to be executed directly**

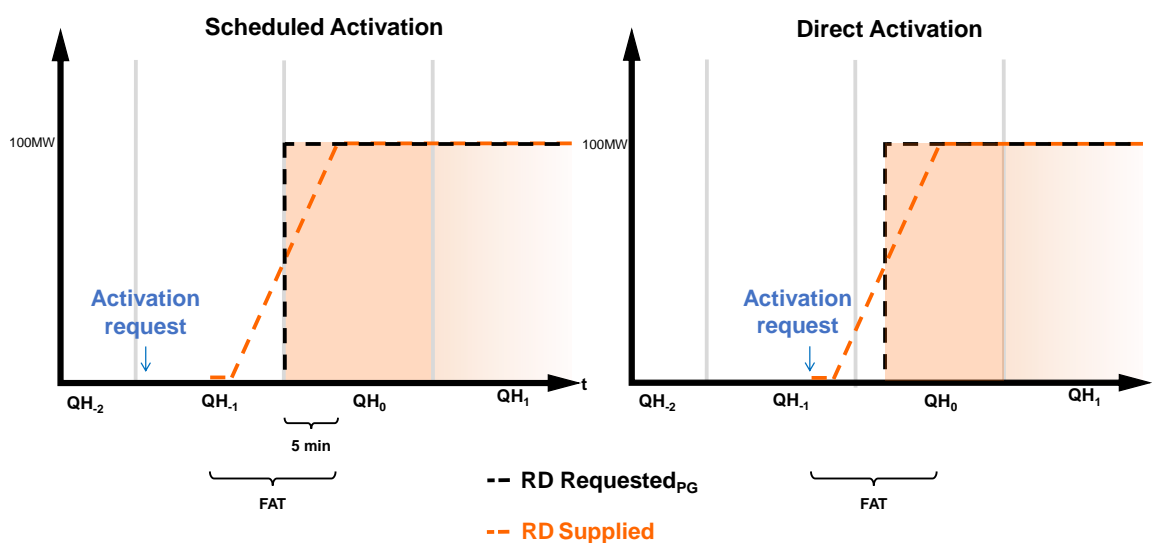

The RD energy bid delivery profile has been aligned with the TSO-BSP shape used for mFRR energy bids in order to facilitate the offering of the same flexibility by different actors in the framework of different flexibility products covering the same delivery points. As a consequence, the shortest (and by default) full activation time for redispatching has been aligned with the full activation time from mFRR i.e. 12,5 min.

## Remuneration of RD activations

Each RD activation will be remunerated based on the energy requested by Elia and the activation price as defined in the RD bid submitted by the SA. The activation price has to be **cost-based** i.e. should reflect the costs for activating the flexibility and therefore be **reasonable, directly related to the activation, and demonstrable**. Elia introduces cost-based redispatching in accordance with article 13 §3(c) of the Clean Energy Package. Indeed, the congestion management is very dependent on the localization of the redispatching means and the number of technical units that can have a significant impact on

<sup>16</sup> Only valid for iCAROS phase 1 : the extension of this concept for smaller units will be assessed during the preparation of iCAROS phase 2

a given congested grid element is limited in Belgium. This situation could lead to a risk of distortion of the market (“inc-dec gaming”) which is substantially reduced if the redispatching is provided at cost-based. In addition, the introduction of the freedom of dispatch and the disappearance of the red zone mechanism will lead to an increase of redispatching activations as the schedule updates of units in electrical zones with an identified congestion risk can no longer be blocked. Cost-based redispatching ensures then that the redispatching costs remain under control and avoid that the cost for the society becomes too high. The combination of freedom of dispatch and cost-based redispatching is part of the so-called “package deal” discussed and agreed with market parties in the framework of iCAROS implementation project.

As a basis for the cost-based price, the SA needs to provide a cost-based formula in the SA contract whose components need to be agreed with Elia at the signature of the SA contract. A non-exhaustive list of acceptable components (such as the fuel costs, the costs related to start-up and shut-down, or the costs related to a loss of subvention) for the cost formula is mentioned in the SA contract. Costs related to losses of market opportunities (e.g. energy that could have been sold on the intraday or balancing market) cannot be part of the cost formula. In case the cost-reflective conditions are not respected, Elia can, in agreement with the CREG, request a revision of the formula.

### Correction of BRP perimeter

Each RD bid activation leads to a correction of the BRP perimeter in charge of the access point to which the technical facility is connected (or the BRP in charge of the delivery point in case multiple BRPs are appointed behind the access point) with the energy requested by Elia as defined in the T&C SA. This correction ensures that no imbalance is created in the perimeter of the BRP when a RD bid activation is requested and correctly executed by the SA. A review of this mechanism will be necessary when the SA will be allowed to be a different party than the BRP.

### Activation control

Each RD activation leads to a compliancy control to ensure the redispatching energy was correctly delivered. The principle of the activation is to verify if the actually supplied energy (RD energy supplied which is the energy corresponding to the difference between the schedule and the active power measured) is equal to or higher (respectively lower) than the requested energy (RD energy requested) for an upward (resp. downward) redispatching activation as summarized in the table below. Overdelivery in the direction of the requested activation is tolerated.

RD activation	Non compliant if
Upward	$RD\ Energy\ to\ be\ supplied - RD\ Energy\ supplied > 0$
Downward	$RD\ Energy\ to\ be\ supplied - RD\ Energy\ supplied < 0$

To consider the possible ramping up or down due to the activation profile or between consecutive quarter-hours of a same activation, Elia introduces the notion of “redispatching energy to be supplied”. The redispatching energy to be supplied is equal to the requested

energy except for two situations in which the redispatching energy to be supplied is equal to 90%<sup>17</sup> of the requested energy:

- For the first quarter-hour of an activation due to the redispatching delivery profile
- For an upward activation (respectively downward), if the requested volume for a given quarter hour is higher (resp. lower) than the requested volume for the previous quarter hour (meaning that a ramp-up (resp. ramp-down) is caused by Elia's activation request) **and** if the sum of the schedule and the requested volume for this given quarter-hour is higher (resp. lower) than the sum of the schedule and the requested volume for the previous quarter hour (meaning that there is an actual ramp-up (resp. ramp-down) performed by the unit).

Some examples of the computation of the redispatching to be supplied are shown on the following figures for upward redispatching activations:

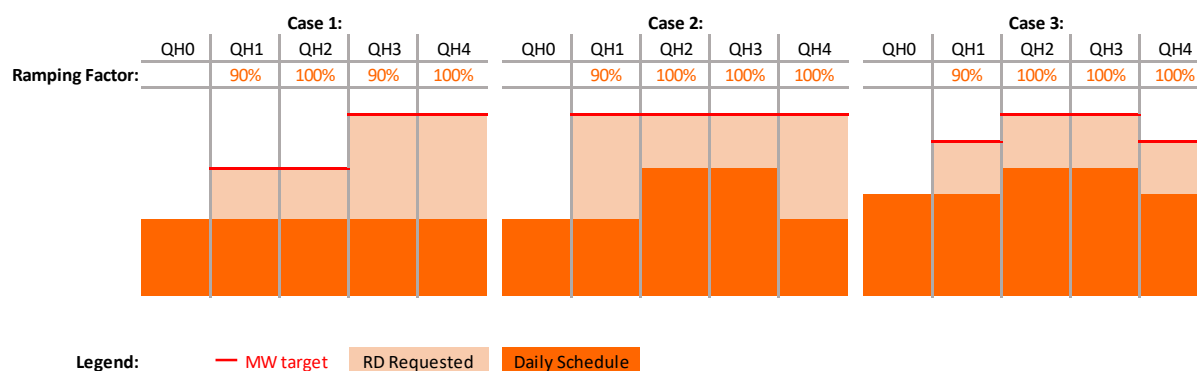

In case of a direct activation, a pro-rata approach is used to determine the redispatching energy to be supplied for the first quarter-hour of the activation.

Examples:

1. A technical facility is composed of one power unit which is then the DP. An upward RD bid activation of 50 MW is requested by Elia on this DP from Qh2 to Qh5. The schedule, RD energy to be supplied and active power measured at DP level are listed in the table below:

<b>07/11/2022</b>	Qh1	Qh2	Qh3	Qh4	Qh5	Qh6
<b>Schedule (MW)</b>	-20	-20	-20	-10	-10	-30
<b>RD energy to be supplied (MWh)</b>	/	0.9 x 12.5 = 11.25	12.5	12.5	12.5	/

<sup>17</sup> This corresponds to the energy actually supplied during a quarter-hour if the unit follows a linear ramping profile in 12.5 min to reach the full requested volume 5 min after the start of the quarter-hour. This 90 % value is used regardless of the full activation time indicated in the bid i.e. even if more energy should actually be delivered due to a longer ramp-up/ramp-down.

Active power measured (MW)	-20	-70	-80	-40	-60	-32
----------------------------	-----	-----	-----	-----	-----	-----

Considering these values, Elia computes the RD energy supplied as:

$$\text{RD Energy supplied} = \frac{1}{4} \times (\text{Schedule} - \text{Active power measured})$$

07/11/2022	Qh1	Qh2	Qh3	Qh4	Qh5	Qh6
RD energy supplied (MWh)	/	12,5	15	7,5	12,5	/

Finally, Elia checks the difference between the RD energy supplied and the RD energy to be supplied

07/11/2022	Qh1	Qh2	Qh3	Qh4	Qh5	Qh6
Max( RD energy to be supplied- RD energy supplied;0) (MWh)	/	0	0	5	0	/

In this example, QH4 is considered as non-compliant as the RD energy supplied is lower than the RD energy to be supplied (the difference between both terms being positive).

- A technical facility is composed of two power units (two DPs – GT and ST). A downward RD bid activation of -20 MW (i.e. RD energy requested = - 5MWh) is requested by Elia on the operating mode (GT+ST) from QH1 to QH6. The schedule and active power measured at DP level are illustrated on the figure below:

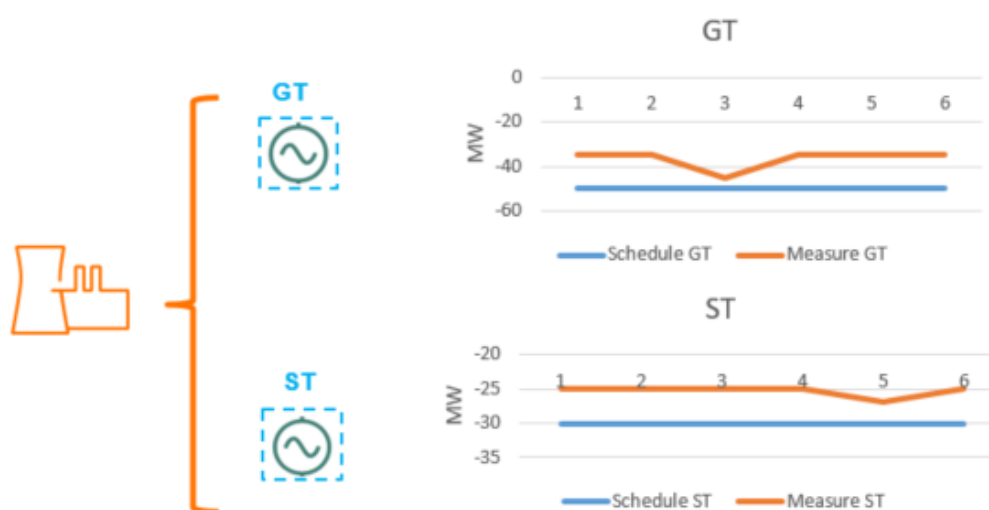

Elia computes the RD energy supplied for each DP:

07/11/2022	Qh1	Qh2	Qh3	Qh4	Qh5	Qh6
RD energy supplied GT(MWh)	-3,75	-3,75	-1,25	-3,75	-3,75	-3,75
RD energy supplied ST (MWh)	-1,25	-1,25	-1,25	-1,25	-0,75	-1,25

Elia compares the total RD energy supplied by both DPs (i.e. the sum of the energy supplied by each DP) with the RD energy to be supplied at providing group level (the providing group being the operating mode in this example):

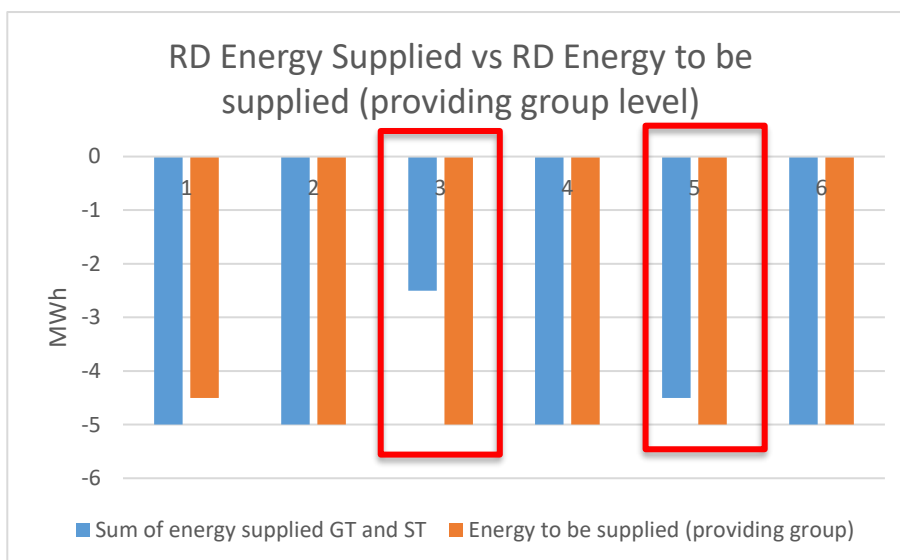

In this example, QH3 and QH5 are considered as non-compliant because the total RD energy supplied is lower than the RD energy to be supplied.

3. A technical facility is composed of three power units (three DPs – GT1, GT2 and ST). Two upward RD bids are requested to be activated on the following operating modes:
  - a. RD Bid 1: 30 MW is requested on operating mode 1 (OM1): GT1 + ST
  - b. RD Bid 2: 20 MW is requested on operating mode 2 (OM2): GT2 + ST

07/11/2022	Qh1	Qh2	Qh3	Qh4	Qh5	Qh6
RD energy to be supplied OM1 (MWh)	0,9 x 7,5 = 6,75	7,5	7,5	7,5	7,5	7,5
RD energy to be supplied OM2 (MWh)	0,9 x 5 = 4,5	5	5	5	5	5

The schedule and active power measured at DP level are illustrated on the figure below:

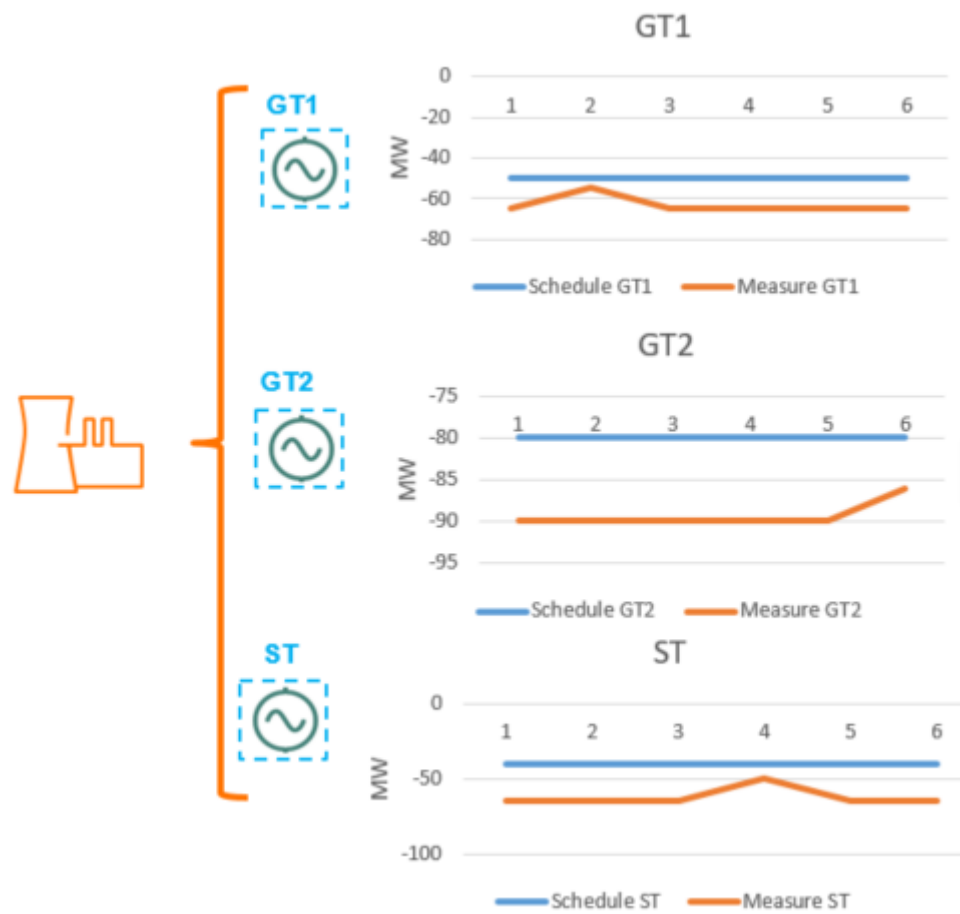

Elia computes the RD energy supplied per for each DP:

07/11/2022	Qh1	Qh2	Qh3	Qh4	Qh5	Qh6
RD energy supplied GT1(MWh)	3,75	1.25	3,75	3,75	3,75	3,75
RD energy supplied GT2 (MWh)	2.5	2.5	2.5	2.5	2.5	1.5
RD energy supplied ST (MWh)	6.25	6.25	6.25	2.5	6.25	6.25

Elia compares the total RD energy supplied (i.e. the sum of the supplied energy by the three DPs) with the total RD energy to be supplied (i.e. the sum of the RD energy to be supplied at providing group level i.e. including both operating modes):

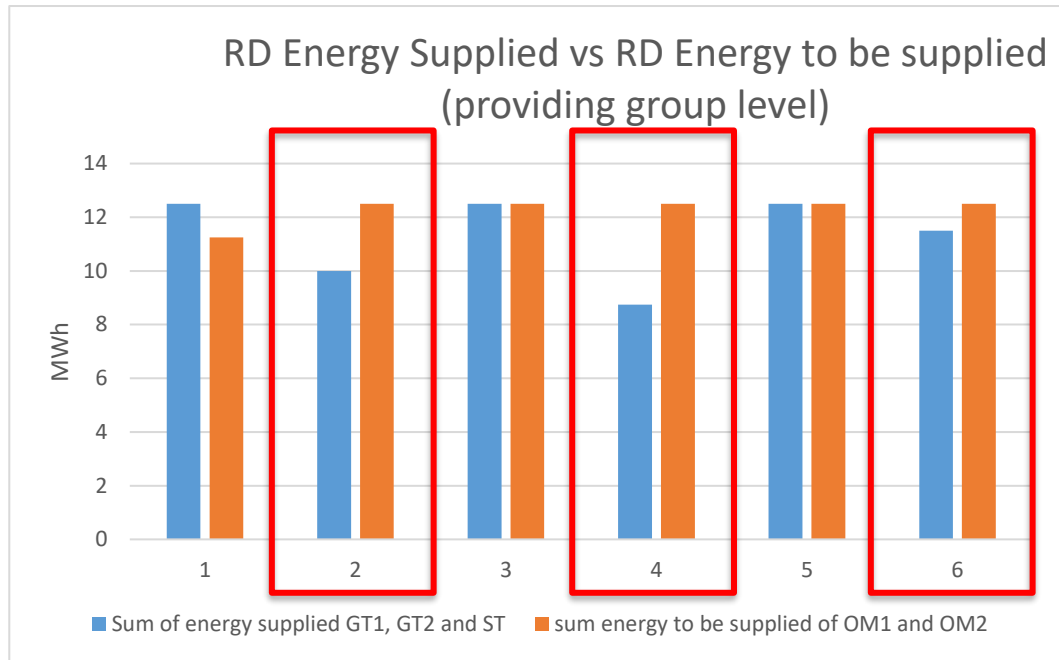

In this example, QH2, QH4 and QH6 are considered as non-compliant because the total RD energy supplied is lower than the total RD energy to be supplied

### Settlement and additional component

Each non-compliant redispatching activation leads to the application of a settlement and possibly of an additional component based on the redispatching energy missing at providing group level i.e.

- $Settlement = RD\ Energy\ Missing_{PG} \times \sum_{bids} (pro - rata_{bid} \times |imbalance\ price - activation\ price_{bid}|)$
- $Additional\ component = |Incentive\ Factor \times RD\ Energy\ Missing_{PG} \times \sum_{bids} (pro - rata_{bid} \times activation\ price_{bid})|$
- 

Where:

1. The **redispatching energy missing** is identified during the activation control and is defined for each qh as the difference between the RD energy to be supplied and RD energy supplied at providing group level:

Examples:

- In the first example above, the activation control leads to the identification of one non-compliant quarter-hour (Qh4) and the RD energy missing is equal to 5 MWh

07/11/2022	Qh1	Qh2	Qh3	Qh4	Qh5	Qh6
RD energy supplied (MWh)	/	12,5	15	7,5	12,5	



RD energy missing (MWh)	/	0	0	5	0	/
-------------------------	---	---	---	---	---	---

- In the second example above, the activation control leads to the identification of two non-compliant quarter-hours (Qh3 and Qh5) with following RD energy missing:

07/11/2022	Qh1	Qh2	Qh3	Qh4	Qh5	Qh6
Total RD energy supplied (MWh)	-5	-5	-2.5	-5	-4.5	-5
RD energy to be supplied (MWh)	-5	-5	-5	-5	-5	-5
RD energy missing (MWh)	0	0	2,5	0	0.5	0

- In the third example above, the activation control leads to the identification of three non-compliant quarter-hours (Qh2, Qh4 and Qh6). In the specific case where the activation of two RD bids with one common DP is requested for one (or more) quarter-hours, Elia computes a total RD energy missing based on the difference between the total RD energy supplied by all DPs contained in the two RD bids and the total RD energy to be supplied at providing group level i.e. for both RD bids:

07/11/2022	Qh1	Qh2	Qh3	Qh4	Qh5	Qh6
Total RD energy supplied (MWh)	12.5	10	12.5	8.75	12.5	11.5
Total RD energy to be supplied (MWh)	12.5	12.5	12.5	12.5	12.5	12.5
Total RD energy missing (MWh)	0	2.5	0	3.75	0	1

2. The **pro-rata term** is relevant in case the activation of multiple RD energy bids with common DP(s) are requested. In these situations, a pro-rata approach based on the requested volume is used to define the settlement to be applied per RD energy bid. In the first and second examples above, the activation of only one RD energy bid is

requested so that the pro-rata factor equals to 1. In the third example, the pro-rata term equals to:

For bid 1 on OM 1 (GT1 + ST):

$$pro - rata_{Bid1} = \frac{RD\ requested_{Bid\ 1}}{RD\ requested_{Bid\ 1} + RD\ requested_{Bid\ 2}} = \frac{30}{30 + 20} = 0.6$$

For bid 2 on OM 2 (GT2 + ST):

$$pro - rata_{Bid2} = \frac{RD\ requested_{Bid\ 2}}{RD\ requested_{Bid\ 1} + RD\ requested_{Bid\ 2}} = \frac{20}{30 + 20} = 0.4$$

3. The **price component** is composed of two terms:

1. A settlement to discourage any gaming induced by the possibility of arbitration between the activation of the RD bid by the SA and the potential benefit for the BRP taking a deliberate open position by not delivering the requested energy (as the perimeter of the BRP is anyway corrected with the requested energy). This additional settlement equals to the difference between the imbalance price and the RD energy bid price and is only applied if the risk of arbitration is present i.e. if
  - For an upward activation (meaning BRP perimeter correction in the downward direction) : Imbalance price < RD Energy Bid price
  - For a downward activation (meaning BRP perimeter correction in the upward direction): Imbalance price > RD Energy Bid price

This settlement is very important to avoid that market parties could benefit from a non-compliant redispatching activation leading to a high risk for the security of the system<sup>18</sup>.

2. An additional component equal to incentive factor times the activation price which is the price indicated in the RD energy bid. The application of this term (including the value of the incentive factor) is described in the Article 2.6 of the T&C SA (“Implementation Date”). At least during a period of 12 months after the go-live of iCAROS phase 1, the incentive factor equals 0%.

An example of application of the settlement and the additional component is illustrated on the figure below where:

- A RD bid activation is requested for a given quarter-hour in the upward direction on one of the delivery points in the portfolio of a SA. The scheduled active energy injection of this DP is 10 MWh and the RD energy requested is equal to 20 MWh.

---

<sup>18</sup> Note that this approach shall be re-evaluated when an effective split of roles and responsibilities between the SA and the BRP will be introduced and, in particular, if the mechanism for the BRP perimeter correction evolves in the future.

With a RD bid price of 100 €/MWh, this leads to a remuneration from Elia to the SA of the delivery point equal to 2000€.

- The activation is not performed by the SA (RD energy missing = 20 MWh). The perimeter of the BRP in charge of the access point (to which the technical facility related to this DP is connected) is anyway corrected with the RD energy requested i.e. a correction of -20 MWh is applied to its perimeter. Assuming the BRP was in balance before the RD activation, the non-compliant activation leads to an imbalance of -20 MWh in the BRP perimeter.

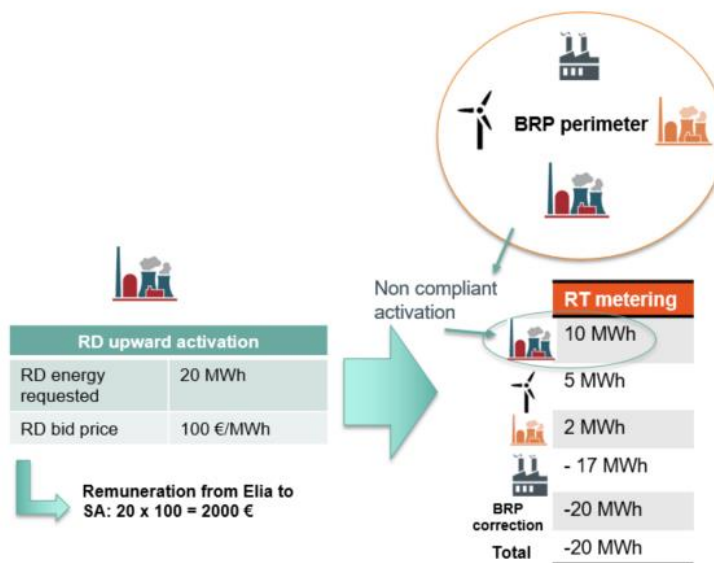

- Two situations are distinguished:
  1. The imbalance price for this quarter-hour is larger than the RD bid price (e.g. 200 €/MWh) leading to an imbalance settlement for the BRP equal to  $-20 \text{ MWh} \times 200 \text{ €/MWh} = -4000 \text{ €}$ . In this case, there is no risk of gaming as a non-compliant RD activation is not beneficial for the BRP and the SA. Only the additional component applies (e.g. below with an incentive factor equal to 5<sup>19</sup>%):

$$20 \text{ MWh} \times 5\% \times |\text{RD bid price}| = 100 \text{ €}$$

2. The imbalance price for this quarter-hour is lower than the RD bid price (e.g. -300 €/MWh) leading to an imbalance settlement for the BRP equal to  $-20 \text{ MWh} \times -300 \text{ €} = 6000 \text{ €}$ . In this case, a non-compliant activation is beneficial for the BRP and the SA as the SA and BRP financial account is positive:

$$\text{Remuneration SA (2000€)} + \text{imbalance settlement BRP (6000€)} = 8000 \text{ €}$$

<sup>19</sup> At least during a period of 12 months after the go-live of iCAROS phase 1, the incentive factor equals 0% (Article 2.6 of the T&C SA ("Implementation Date")).

The settlement avoids gaming by neutralizing the benefits resulting from the non-compliant activation i.e.

$$20 \text{ MWh} \times |\text{imbalance price} - \text{RD bid price}| = 8000 \text{ €}$$

The total applied settlement is then equal to the sum of the settlement to discourage gaming and the additional component:

$$\text{Total settlement} = 8000 \text{ €} + 100\text{€} = 8100 \text{ €}$$

## Cancellation

Elia can fully cancel a previously requested scheduled activation of a RD bid until whichever value comes first: RD GCT or the activation deadline of the RD bid for the concerned quarter-hour (i.e. the last moment a scheduled activation can be requested considering the FAT). The remuneration of the scheduled activation of a RD Bid will only be canceled if Elia revokes the scheduled activation before D-1 10 PM. If the annulment is done in ID (and not triggered by a forced outage of the technical unit linked to the activated delivery point), the remuneration will be maintained as costly actions might already have been taken by the SA on the technical unit linked to the activated delivery point and market opportunities might be lost.

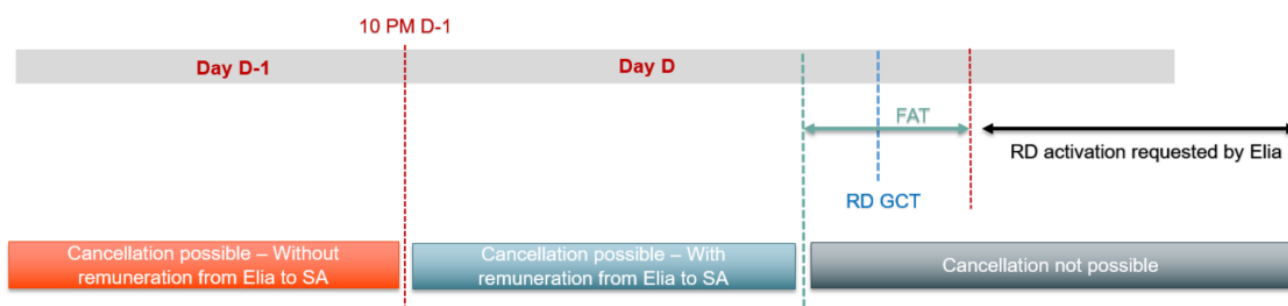

Note that the annulment of a RD bid activation is a needed option for exceptional circumstances implying large unexpected changes in the grid. However, this option should not be used frequently by Elia as RD bids are typically activated once the need is confirmed.

## 6. Evolutions related to Congestion Management

### 6.1. Congestion Risk Indicator (CRI)

In line with the introduction of the freedom of dispatch as described in the Section 5.3, Elia modifies the methodology of the existing red zones mechanism to allow the schedules to be updated in all electrical zones without Elia validation (except in some specific situations as described in Section 5.3) until RD GCT. A red zone (RZ) is currently defined as the status of an electrical zone, for a defined direction (upward/downward) and for a defined period of the day, in which a constraint in MW has been set with regards to production program adaptation on technical units linked to a specific delivery point, which is subject to scheduling obligations situated in this electrical zone. With the current red zones mechanism, if an electrical zone

has a “red” status in a given direction, schedule updates in this direction from delivery points covered by a SA contract are not authorized. The red zone mechanism is also used to set a limit on balancing bids activation if a risk of congestion is detected in a defined electrical zone.

Together with the removal of the red zone mechanism for schedule updates of delivery points, Elia introduces the notion of Congestion Risk Indicator (CRI) that represents the congestion risk in a Belgian electrical zone. The goal of the CRI is different from the red zone as:

- It does not prevent any updates of schedules for delivery points in a given electrical zone (ensuring freedom of dispatch)
- It is mainly used to set a limit on aFRR/mFRR activations in case a risk of congestion is present in an electrical zone so that balancing activations cannot create or aggravate a congestion risk. The filtering of balancing bids will be described in details in the T&C aFRR; T&C mFRR and the Balancing Rules document.
- It is also used as an input for Elia to identify the need of remedial actions to solve a congestion issue detected in an electrical zone such as a request of return to schedule or the activation of a RD bid

The main characteristics of the CRI are defined in the table below:

Congestion Risk Indicator	
<b>Geographical granularity</b>	Electrical zone
<b>Time granularity</b>	Hour
<b>Direction</b>	Upward, downward or both
<b>Level</b>	Low, medium or high

### 6.1.1. Identification of electrical zone subject to CRI level

Annually (at least) or ad hoc (per trigger) Elia defines the electrical zones subject to a level of CRI as described in detail in the Rules for Coordination and Congestion Management. The monitored elements, on which the impact of the received schedules will be assessed in order to determine the CRI levels, will only be those identified as cross-zonal during the electrical zone determination. In other words, the principle behind the electrical zone determination process is that a line with a congestion risk should be crossing electrical zones (“cross-electrical zone”) and will be monitored during the process of CRI level determination. The congestions of the lines inside an electrical zone will be ignored during the process of CRI determination (hypothesis of copper plate inside an electrical zone), except if there is a relevant outage that creates structural congestion inside a zone. In this case an internal line shall be monitored (used as a monitored line) temporarily. If a monitored element is regularly identified inside an electrical zone, the electrical zone will be re-organized so that this monitored element becomes cross-electrical zone as shown in the example below:

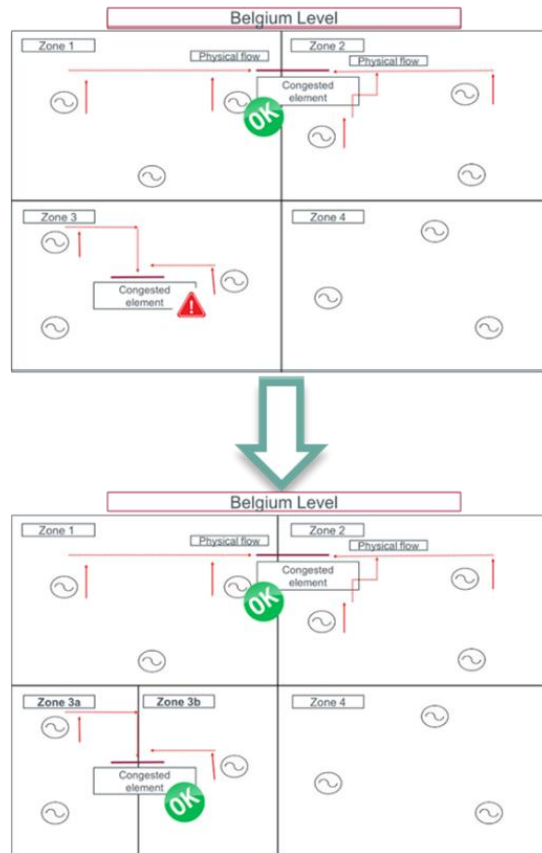

### 6.1.2. Determination of the CRI levels

The determination of the CRI level is a two-steps process that is described in detail in the Rules for Coordination and Congestion Management and summarized in the following figure:

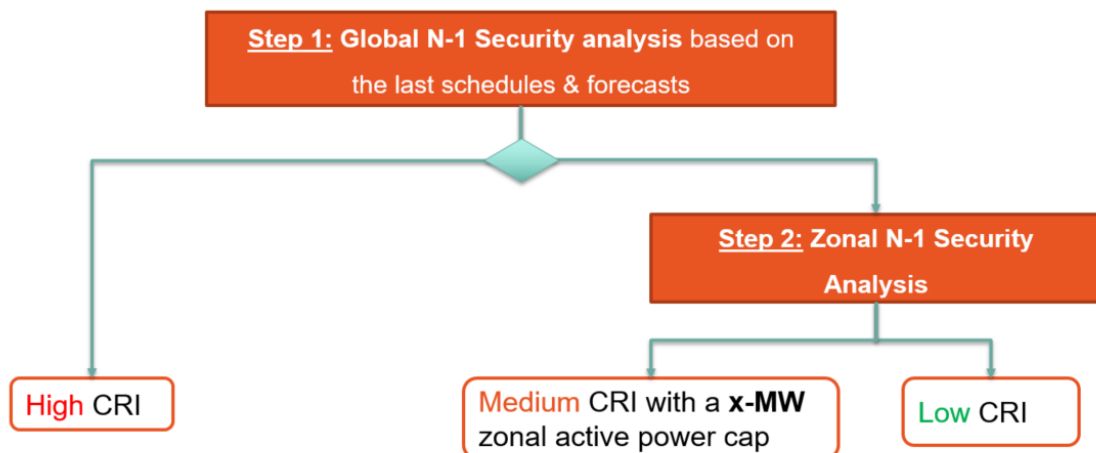

To illustrate the process, the following example is provided:

- The first step is the application of the global N-1 security analysis allowing to assess the security of the grid. The figure below illustrates the performed analysis :

- No congestion is detected for the monitored elements a, b, c and d for the main relevant contingencies<sup>20</sup> analyzed. An overload on element a is detected in case of the trip of the transformer y but can be managed via a (non-costly) remedial action
- The monitored line f is congested in case of trip of line z even after application of non-costly remedial actions. This means that a high CRI needs to be defined in the zone 3b (in the upward direction) and zone 4 (in the downward direction)

#### Outcomes of Step 1: securing the grid

N-1		Loading [%]	Remedial action
Monitored lines	Contingency (C)		
Zone 1 -> Zone 2			
a	Line x	80%	
c	Line x	75%	
a	Tfo y	117% → 90%	Coupler A
c	Tfo y	50%	
Zone 1 -> Zone 3a			
b	Line w	53%	
d	Line w	60%	
b	Tfo v	37%	
d	Tfo v	75%	
Zone 3b -> Zone 4			
Line f	Line z	115%	PST taps

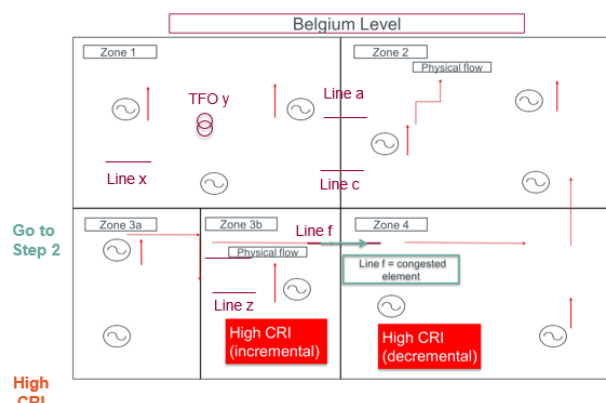

- The second step consists of analysing the impact of an increase/decrease of net injection of active power on the monitored elements to determine the CRI level (low or medium) for each zone (except those with a high CRI) via zonal N-1 security analysis. The net injection of active power (distributed in the zone by GLSK – Generator and Load Shift Keys<sup>21</sup>) is gradually increased/decreased until one of the monitored element is overloaded. The increase/decrease of net injection leading to this overload corresponds to the zonal active power cap in the concerned direction. In the example, the results of this analysis for the zone 1 (as presented in the table below) show that an increase of net injection above 120 MW would create the first congestion (on the line a due to a contingency of the line y).

<sup>20</sup> A contingency is a trip of an element that is simulated during N-1 analysis.

<sup>21</sup> These GLSKs represent the distribution of the increase (resp. decrease) of net injection due to balancing offers in the analysed zone

Result of Step 1  
= no high CRI

		Increase in net injection in zone 1 [MW]						
Monitor ed line	C (N-1)	0	20	40	60	80	100	120
Line a	Line x	80%	82%	83%	85%	86%	88%	90%
b	x	53%	59%	64%	69%	75%	80%	85%
c	x	75%	76%	77%	78%	79%	80%	81%
d	x	60%	60%	59%	59%	58%	58%	57%
a	y	90%	92%	93%	95%	96%	98%	101%
b	y	37%	42%	47%	53%	58%	63%	69%
c	y	50%	51%	52%	53%	54%	55%	56%
d	y	75%	75%	74%	74%	73%	73%	72%

Elia then compares this value with a specific threshold which is defined per electrical zone, per direction and per hour based on the remaining flexibility of all technical units (that are coordinable in the considered direction) in the electrical zone. The remaining flexibility in upward direction is determined as the sum of the individual remaining upward flexibility of each technical unit (coordinable in the upward direction) in the electrical zone that is computed as the difference between the maximum technical power of these technical units and their schedules (for technical units included in a SA contract) or an active power reference based on forecasts<sup>22</sup> (for technical units not included in a SA contract).

The level of the CRI is then determined as follows:

- If 120 MW > threshold: low CRI
- If 120 MW <= threshold: Medium CRI with zonal active power cap equal to 120 MW

### Monitoring and publications

As defined in the Rules for Coordination and Congestion Management, Elia will make the following data available:

- Daily publication and notification:
  - All CRI levels of the electrical zones will be published when calculated initially and up-dated on the Elia website
  - Notifications to all impacted market parties will be made
- Historical data available on Elia platform OpenData for statistical analysis
- Annual reporting

<sup>22</sup> As described in the study available here: [https://www.elia.be/-/media/project/elia/elia-site/grid-data/congestion-management/20221227\\_congestion-management-incentive-2022---final-report\\_23\\_12\\_2022.pdf](https://www.elia.be/-/media/project/elia/elia-site/grid-data/congestion-management/20221227_congestion-management-incentive-2022---final-report_23_12_2022.pdf)



- Publication of statistics on the CRI levels such as the number of high/medium CRI per zone
- Publication of statistics on the impact of the CRI levels on balancing bids availability per zone
- List of electrical zones and monitored elements

## 6.2. Other modifications to the Rules for Coordination and Congestion Management

In addition to the introduction of the CRI methodology (replacing the red zones one), some other modifications are made in the Rules for Coordination and Congestion Management. The main modifications concern the alignment of the document with the concepts introduced by the iCAROS design (such as the evolution of the redispatching process or the introduction of the return to schedule request) or some changes related to the CREG decision B2056 about the first version of the Rules for Coordination and Congestion Management. These changes mainly consist in clarifying some terms in the document or removing some articles that belong in a more appropriate way to the new T&C OPA (such as the financial modalities to request a change of availability status) or T&C SA (such as some modalities for the request of a must run/may not run). Two specific changes are however described in the following section.

### Compensation mechanism

In order not to create imbalance on the grid, the activations of RD bids to solve internal operational security issues are compensated by Elia. For this purpose, Elia requests the activation of a balancing bid (“compensation bid”) in the opposite direction to the requested RD bid to maintain the balance of the grid.

The current approach to perform this compensation is to request systematically the compensation bid simultaneously with the RD bid. As introduced in the new mFRR design, Elia proposes an evolution towards a more efficient mechanism consisting in considering the compensation need for redispatching to assess the need for (mFRR) balancing activations, benefiting from a netting effect with possible other RD activations or mFRR prequalification/availability tests in opposite direction. This approach also allows the use of the liquidity available via the MARI platform for the compensation of the RD bid activation.

This new approach for the compensation mechanism is described in the relevant section of the Rules for Coordination and Congestion Management.

This mechanism will be applied to compensate activations of redispatching requested by Elia for internal congestions and can also be applied for the compensation of countertrading activations on the BE-UK border requested to solve congestions in the Belgian grid or UK grid<sup>23</sup>. Indeed, countertrading on BE-UK border consists in changing the power flow on the HVDC cable between BE and UK to solve a congestion and adapting the power generation/offtake in both countries accordingly. As these adaptations of the power

---

<sup>23</sup> In accordance with the modalities defined in the bilateral agreement with the TSO for Great Britain regarding countertrading.

generation/offtake do not need to be precisely localized in Belgium, balancing activations via the European mFRR- balancing platform MARI can be used. Consequently, the volume of active power necessary for compensating the countertrading activation on the BE-UK border can also be considered to assess the need for (mFRR) balancing activations. Note that this approach is however not applicable for cross-border redispatching activations as these activations need to be localized in Belgium to ensure a positive impact on the congestion as well as for countertrading activations with other neighboring countries than UK for which the compensation cannot come from anywhere in continental Europe to also ensure a positive impact on the congestion. In other words, those volumes cannot be sourced through the European balancing platform MARI since this provides no information on the location in Europe of the activated bid, and hence do not ensure a positive impact on the congestion.

### **Intraday market access**

Elia introduced in 2019 a mechanism allowing Elia to access to the intraday market for the compensation of some specific countertrading activations on Nemo Link (described in the “Intraday Market access rules”). Due to the evolution of the compensation mechanism with expected access to more liquidity (as described previously) and due to the replacement of the red zones by the CRI levels (preventing a safe use of a trade on the intraday market for the compensation as this could lead to an activation in a congested electrical zone), Elia has decided to stop using this mechanism as from iCAROS phase 1 go-live and removed the reference to it in the new version of the Rules for Coordination and Congestion Management.