

# Description and Use of Metering Messages transmitted by Elia

The purpose of this document is to explain how to access, understand and use messages containing metering data transmitted by Elia. It describes the content of the messages, how they are transmitted, the type of data transmitted and how this data can be implemented in client's business applications.

This manual should be read by:

- Metering operational staff who need to understand the contents of metering messages
- IT Developers, who need to use the message content in the implementation of custom applications

Version: 3.1

Publication: September 2021

Contact email address in case of business or technical issues: [metering.services@elia.be](mailto:metering.services@elia.be)

*Elia hereby excludes all liability (whether in contract, tort, delict, quasi-delict, statute or strict liability) for any type of damage, direct or indirect, consequential, or of any other nature, resulting of the use of this document*

*For the avoidance of doubt, Elia does not accept any liability for the acts or omissions of the users of this document.*

## Table of Contents

<b>Chapter 1 Metering concepts</b>	<b>11</b>
1.1. Metered data	11
1.1.1. Active and reactive power	11
1.1.2. Direction	11
1.1.3. Quantities	12
1.2. Messages	14
1.2.1. Market roles	14
1.2.2. Message types	15
1.2.3. Message validity	17
1.2.4. Message delivery	17
1.2.5. Accessing messages – protocols	18
1.2.6. Accessing messages – formats	18
1.2.7. Message formats and protocols independency	18
1.2.8. Regulated messages & message delivery frequency	19
1.3. Related documents	24
<b>Chapter 2 Understanding messages</b>	<b>25</b>
2.1. Access Point	25
2.1.1. Recipients	25
2.1.2. Accessing Access Point messages	25
2.1.3. Message content	25
2.2. Service Point	28
2.2.1. Recipients	28
2.2.2. Accessing Service Point messages	28
2.2.3. Message content	29
2.3. Metering Point	29
2.3.1. Recipients	29
2.3.2. Accessing Metering Point messages	29
2.3.3. Message content	29
2.4. CDS Access Point	33
2.4.1. Recipients	33
2.4.2. Accessing CDS Access Point messages	33
2.4.3. Message content	33
2.5. CDS Loop Losses (PBO)	37
2.5.1. Recipients	38
2.5.2. Accessing CDS Loop Losses (PBO) Message	38
2.5.3. Message content	38
2.6. Infeed TSO per substation	43
2.6.1. Recipients	43
2.6.2. Accessing Infeed TSO per substation messages	43

2.6.3. Message content .....	43
2.7. Infeed TSO per substation and per supply bay .....	47
2.7.1. Recipients .....	47
2.7.2. Accessing Infeed TSO per substation and per supply bay messages	47
2.7.3. Message content .....	47
2.8. GEMP .....	51
2.8.1. Recipients .....	52
2.8.2. Accessing GEMP messages .....	52
2.8.3. Message content .....	52
2.9. Imbalance .....	56
2.9.1. Recipients .....	57
2.9.2. Accessing Imbalance messages .....	57
2.9.3. Message content .....	57
2.10. Transfer of Energy (ToE) Delivered volumes .....	69
2.10.1. Recipients .....	69
2.10.2. Accessing Transfer of Energy (ToE) delivered volumes messages	70
2.10.3. Message content .....	70
2.11. Real-Time DGO Allocation.....	75
2.11.1. Recipients .....	75
2.11.2. Accessing Real-Time DGO Allocation messages .....	75
2.11.3. Message content .....	75
2.12. DGO Border Point and Supply Bay metering.....	80
2.12.1. Recipients .....	80
2.12.2. Accessing DGO Border Point and Supply Bay messages .....	80
2.12.3. Message content .....	80
2.13. Delta TS report .....	84
2.13.1. Recipients .....	84
2.13.2. Accessing Delta TS messages .....	84
2.13.3. Message content .....	84
2.14. Delta DGO Exchanges (DGO2DGO) report .....	88
2.14.1. Recipients .....	89
2.14.2. Accessing Delta DGO Exchanges (DGO2DGO) messages.....	89
2.14.3. Message content .....	89
2.15. DGO Loop Losses (DGO PBO) report .....	93
2.15.1. Recipients .....	94
2.15.2. Accessing DGO Loop Losses (DGO PBO) Message .....	94
2.15.3. Message content .....	94
2.16. DGO Reactive Area and Supply Bay (DGO RA) .....	98
2.16.1. Recipients .....	98
2.16.2. Accessing DGO Reactive Area and Supply Bay (DGO RA) Message	98
2.16.3. Message content .....	98

<b>Chapter 3 CSV format messages .....</b>	<b>102</b>
3.1. CSV Access Point messages .....	102
3.1.1. Message structure .....	102
3.2. CSV Service Point messages .....	105
3.3. CSV Metering Point messages .....	105
3.3.1. Message structure .....	106
3.4. CSV CDS Access Point messages .....	108
3.5. CSV CDS Loop Losses (PBO) messages .....	109
3.5.1. Message structure .....	109
3.6. CSV Infeed TSO per substation messages.....	112
3.6.1. Message structure .....	112
3.7. CSV Infeed TSO per substation and per supply bay messages .....	115
3.7.1. Message structure .....	115
3.8. CSV GEMP messages .....	118
3.8.1. Message structure .....	119
3.9. CSV Imbalance messages.....	123
3.9.1. Message structure .....	123
3.10. CSV Transfer of Energy (ToE) Delivered volumes messages .....	126
3.10.1. Message structure .....	126
3.11. CSV Real-Time DGO Allocation messages .....	129
3.11.1. Message structure .....	130
<b>Chapter 4 XML format messages .....</b>	<b>134</b>
4.1. Reference XSD .....	134
4.2. XML Access Point messages .....	134
4.2.1. Message structure .....	134
4.3. XML Metering Point messages .....	136
4.3.1. <header> .....	136
4.3.2. <data-list>.....	137
4.4. XML CDS Loop Losses (PBO) messages .....	137
4.4.1. XML CDS Loop Losses (PBO) Header fields.....	138
4.4.2. XML CDS Loop Losses (PBO) TimeSeries fields .....	139
4.4.3. XML CDS Loop Losses (PBO) Period fields.....	140
4.4.4. XML CDS Loop Losses (PBO) Point fields.....	140
4.5. XML Infeed TSO per substation messages.....	141
4.6. XML Infeed TSO per substation and per supply bay messages .....	143
4.7. XML GEMP messages .....	145
4.7.1. Message structure .....	145
4.7.2. ARPGemp .....	145
4.7.3. ARPRegionGemp .....	146
4.7.4. ARPSupplierGemp .....	148
4.8. XML Imbalance messages.....	150



4.8.1.	XML Imbalance Header fields .....	150
4.8.2.	XML Imbalance TimeSeries fields.....	152
4.8.3.	XML Imbalance Period fields .....	155
4.8.4.	XML Imbalance Point fields .....	155
4.9.	XML Transfer of Energy (ToE) delivered volumes .....	156
4.9.1.	XML Transfer of Energy (ToE) delivered volumes Header fields.	157
4.9.2.	XML Transfer of Energy (ToE) delivered volumes TimeSeries fields	158
4.9.3.	XML Transfer of Energy (ToE) delivered volumes Period fields ..	159
4.9.4.	XML Transfer of Energy (ToE) delivered volumes Point fields....	160
4.10.	XML Real-Time DGO Allocation Estimation .....	162
4.10.1.	XML Real-Time DGO Allocation Estimation Header fields.....	162
4.10.2.	XML Real-Time DGO Allocation Estimation TimeSeries fields ....	164
4.10.3.	XML Real-Time DGO Allocation Estimation Period fields .....	164
4.10.4.	XML Real-Time DGO Allocation Estimation Point fields .....	165
4.11.	XML DGO Border Point and Supply Bay (DGOBP) message.....	166
4.11.1.	XML DGOBP Header fields.....	166
4.11.2.	XML DGOBP TimeSeries fields .....	167
4.11.3.	XML DGOBP Period fields.....	169
4.11.4.	XML DGOBP Point fields.....	170
4.12.	XML DeltaTS message.....	172
4.12.1.	XML Delta TS <header> .....	172
4.12.2.	XML Delta TS TimeSeries fields .....	173
4.12.3.	XML Delta TS Point fields.....	176
4.13.	XML Delta DGO Exchanges (DGO2DGO) message.....	177
4.13.1.	XML Delta DGO Exchanges (DGO2DGO) Header fields .....	177
4.13.2.	XML Delta DGO Exchanges (DGO2DGO) TimeSeries fields .....	178
4.13.3.	XML Delta DGO Exchanges (DGO2DGO) Point fields.....	181
4.14.	XML DGO Loop Losses (DGO PBO) messages .....	181
4.14.1.	XML DGO Loop Losses (DGO PBO) Header fields.....	183
4.14.2.	XML DGO Loop Losses (DGO PBO) TimeSeries fields .....	184
4.14.3.	XML DGO Loop Losses (DGO PBO) Period fields.....	185
4.14.4.	XML DGO Loop Losses (DGO PBO) Point fields.....	185
4.15.	XML DGO Reactive Area and Supply Bay metering message.....	186
4.15.1.	XML DGO Reactive Area and Supply Bay metering Header fields	187
4.15.2.	XML DGO Reactive Area and Supply Bay metering TimeSeries fields	188
4.15.3.	XML DGO Reactive Area and Supply Bay metering Period fields	190
4.15.4.	XML DGO Reactive Area and Supply Bay metering Point fields..	190
4.16.	XML elements .....	191
4.16.1.	Party elements.....	191
4.16.2.	Point elements .....	192

4.16.3. Schedule elements .....	193
4.17. Data types.....	195
<b>Chapter 5 Excel (XLSX) format messages .....</b>	<b>196</b>
5.1. Excel Access Point messages.....	196
5.1.1. Message structure .....	197
5.2. Excel Metering Point messages.....	199
5.2.1. Message structure .....	200
5.3. Excel CDS Loop Losses (PBO) messages.....	200
5.3.1. Message structure .....	200
5.4. Excel Infeed TSO per substation messages .....	203
5.4.1. Message structure .....	203
5.5. Excel Infeed TSO per substation and per supply bay messages .....	205
5.5.1. Message structure .....	205
5.6. Excel GEMP messages .....	206
5.6.1. Message structure .....	206
5.7. Excel Imbalance messages .....	207
5.7.1. Message structure .....	207
5.8. Excel Transfer of Energy (ToE) delivered volumes.....	209
5.8.1. Transfer of Energy (ToE) delivered volumes- Sheet "Summary" structure .....	210
5.8.2. Transfer of Energy (ToE) delivered volumes - Sheet "Detail" structure .....	212
5.9. Excel DGO Loop losses (DGO PBO) metering messages .....	214
5.9.1. Sheet "Summary" structure .....	214
5.9.2. Sheet [DGO Network name] structure.....	217
5.10. Excel Delta TS (DTS) metering messages .....	218
5.10.1. Sheet "Summary" structure .....	219
5.10.2. Sheet "Detail" structure .....	221
5.11. Excel Delta DGO Exchanges (DGO2DGO) metering messages .....	223
5.11.1. Sheet "Summary" structure .....	223
5.11.2. Sheet "Detail" structure .....	226
5.12. Excel Real-Time DGO Allocation messages.....	228
5.12.1. Message structure .....	228
5.13. Excel DGO Border Point and Supply Bay (DGOBP) metering messages	230
5.13.1. Sheet "BorderPoint" structure .....	230
5.13.2. Sheet "Supply Bay" structure.....	233
5.14. Excel DGO Reactive Area and Supply Bay metering messages.....	234
5.14.1. Sheet "Reactive Area" structure .....	235
5.14.2. Sheet "Supply Bay" structure.....	238
<b>Chapter 6 Accessing messages.....</b>	<b>240</b>
6.1. Characteristics of the different protocols.....	240



- 6.2. The EVMSB2C protocol ..... 240
- 6.3. SFTP protocol..... 241
  - 6.3.1. Use of certificates: Public key – private key ..... 241
- 6.4. Metering messages name ..... 243
  - 6.4.1. EVMSB2C message file names ..... 243
  - 6.4.2. FTP Metering message file names ..... 244
- 6.5. Time formatting and Daylight saving ..... 245
  - 6.5.1. Time and date formatting ..... 245
  - 6.5.2. Daylight saving ..... 246
  - 6.5.3. Value periods in a message ..... 246

Abbreviation	Description
AC	Alternating Current
ACH	Access Contract Holder
aFRR	automatic Frequency Restoration Reserve
AP	Access Point
BRP	Balance Responsible Party Note: the former term "ARP" (Access Responsible Party) is still used in some documents or file names to maintain compatibility.
BRP <sub>O.I.</sub>	Balance Responsible Party associated with an Offshore Interconnector
ASCII	American Standard Code for Information Interchange
B2B	Business to Business
BA	Business Application
BSP	Balancing Service Provider (generic role)
C	Compensated values
CC	Compensated Corrected values
CDS	Closed Distribution System
CDSO	Closed Distribution System Operator
CSV	Comma Separated Values
DGO	Distribution Grid Operator
DGOBP	Distribution Grid Operator Border Point
DCP	DGO Connection Point
DSO	Distribution System Operator: In this document this term has exactly the same meaning as the DGO
DP	Distribution Point
EAN	European Article Number
EIC	Energy Identification Code
ENTSO-E	European Network of Transmission System Operators for Electricity
EVMSB2C	Web site allowing to download the metering publications
FDM	Flexibility Data Manager
FTP	File Transfer Protocol
G	Gross power
GEMP	Global Elia Metered Position
GU	Grid User
MCH	Metering Contract Holder
MRCO	Meter Reading Company
N	Net Power

NC	Non-Compensated values
PBO	In French "Pertes de Bouclage": Loop losses, clearing differences or allocation control
PROD	Producer
mFRRCipu (mFRRDPsu)	manual Frequency Restoration Reserve delivered by CIPU units (also known as DP <sub>SU</sub> )
mFRRNonCipu (mFRRDPpg)	manual Frequency Restoration Reserve delivered by non CIPU units (also known as DP <sub>PG</sub> ). Equivalent of the former R3 Flex & R3E
DA/ID	DA/ID flexibility service delivered by DP <sub>PG</sub> delivery points (former non CIPU units). This flexibility service is provided by FSPs in the context of energy trades carried out by the BRP <sub>FSP</sub> (associated to this FSP) on the Day-Ahead and IntraDay markets.
R3Flex	Tertiary Control Power Service by Non CIPU Technical units. Replaced by mFRRNonCipu
R3E	Tertiary Control Non Reserved Power Service by Non CIPU Technical units (Bidladder). Replaced by mFRRNoncipu
SDR	Strategic Demand Reserve
SGR	Strategic Generation Reserve
SP	Service Point
SUP	Supplier
ToE	"Transfer of Energy" as introduced by the Law of 13 <sup>th</sup> of July 2017
TSO	Transmission System Operator (Elia in this document)
UMIG	Utility Market Implementation Guide
XLSX	Microsoft ® Excel format and file qualifier
XML	eXtensible Markup Language

## Introduction

This document describes all aspects of metering data provided by Elia. This includes how to understand metering messages and how to access messages delivered via one of the protocols put at disposal by Elia.

This document serves three purposes:

- To provide clear understandable explanations of the data contained in metering messages. This information is for the use of operational staff, who need to understand message content and its application.
- To explain the use of the <https://evmsb2c.elia.be> web page to the operational staff.
- To provide reference information for IT Developers who need to build business applications for both accessing and using metering data. Especially:
  - To explain the use of the SFTP protocol, adopted for the transfer of messages from Elia to its clients.

This document is structured as follows:

Chapter 1 describes all the concepts relating to metering messages, as well as the types of clients who can receive them. The terminology used in this chapter should be understood by both operational and development staff.

Chapter 2 contains general explanations of the contents of all message types. This information is aimed at the operational staff who need to understand message content.

Chapter 3, Chapter 4 and Chapter 5 contain detailed information on all the message fields and are targeted more at developers who need to access this information for use in their own business applications.

Chapter 6 explains how to access messages. It describes the different available protocols: it sets out the advantages of the use of the common communication protocol, which is of interest to all recipients, as well as detailed reference sections on the use of the protocol.

## Chapter 1 Metering concepts

### 1.1. Metered data

This section provides a general description of all the parameters used in the metering messages to describe measured data. In all the regulated messages, the measured data is electrical power. In the non-regulated messages, other quantities can be measured, both electric and non-electric. The way the parameters are incorporated into the metering messages is described in Chapter 2 "Understanding messages".

#### 1.1.1. Active and reactive power

An AC power flow is made up of active and reactive components. The active part is the real component of the power which can be used to perform real work. Active power is expressed in Watts (W). Active power is absorbed by resistive loads (the current and voltage are in phase).

Reactive power is absorbed by inductive or capacitive loads which cause the current and voltage to become out of phase. Both types of loads absorb energy during one part of the cycle that is stored in the device's electric and magnetic fields and which is returned to the source during another part of the cycle thus representing an inefficiency or loss. Reactive power is measured in Volt-Amperes Reactive (VAR).

Inductive loads, such as transformers or motors, cause the current to lag the voltage. Inductive power is in the same direction as the active power. Capacitive loads cause the current to lead the voltage. Capacitive power is in the opposite direction to the active power.

Knowing whether the power being used is active or reactive is interesting given the inefficiencies associated with reactive power.

#### 1.1.2. Direction

Power can flow into and out of the Elia grid:



Figure 1 Direction of power flow with the Elia grid

Power flowing from Elia to the client is also referred to as "offtake" and power flowing from the client into the Elia grid is also referred to as "injection":

- In the CSV formatted messages (described in Chapter 3) the direction of power flow is indicated by the labels CONS (consumption) and PROD (production).
- In the XML formatted messages (described in Chapter 4) the power flow is indicated by the <partyFrom> and the <partyTo> elements. Power is transferred FROM <partyFrom> TO <partyTo>.
- In the XLSX formatted messages (described in Chapter 5) the direction of power flow is indicated by the labels Outgoing (consumption) and Incoming (production).

All power values provided in metering messages are positive values which have an associated direction. Metering messages therefore can contain (up to) 6 components: incoming Active, Capacitive, Inductive and outgoing Active, Capacitive, Inductive.

Concerning specific messages like the Imbalance messages: power can flow into and out of the BRP Balance perimeter (see 2.9).

### 1.1.3. Quantities

Metering data is provided as series of power values. These values represent the average power transferred during value periods of 15 minutes (also known as quarter-hour values).

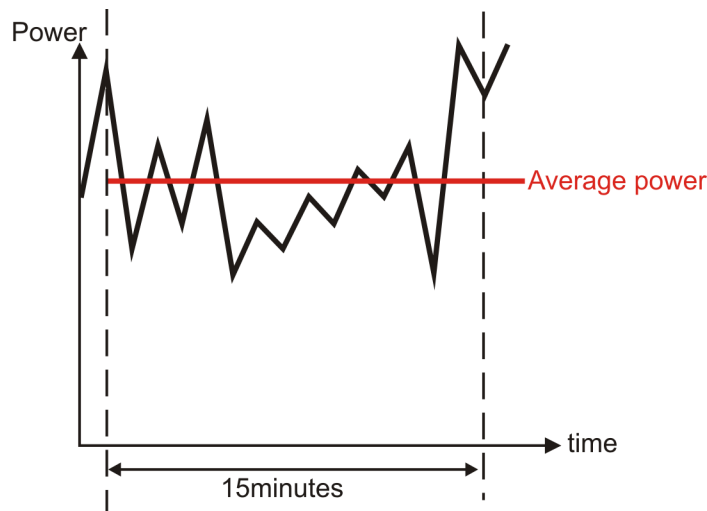

Figure 2 Averaged 15 minutes (quarter-hour) values

The series of value periods are delivered in a 'schedule' which has a specific duration. The duration is a single day. Each message contains all the daily schedules of a month. The duration is presented as a number of minutes. The number of value periods contained in a schedule is therefore the duration/15.

The number of value periods in a "normal" day is therefore  $(24 \cdot 60) / 15 = 96$ .

Due to daylight saving requirements, there is one day in the year which consists of 25 hours (and therefore 100 value periods), and one day which consists of 23 hours (and therefore 92 value periods). The switch between winter time and summer time for daylight saving reasons has implications for business applications that use metering data. For more detailed information, refer to section 6.5.2.

#### 1.1.3.1. Compensation

Compensated power values account for changes in direction during the 15 minutes (quarter-hour) period. Consider the situation illustrated in the figure below, where during one part of the value period, power is produced and during the other part, power is consumed.

In the case of non-compensated, two values will be provided: the averaged non-compensated production and the averaged non-compensated consumption.

Non-compensated values are labelled "NC" in a message.

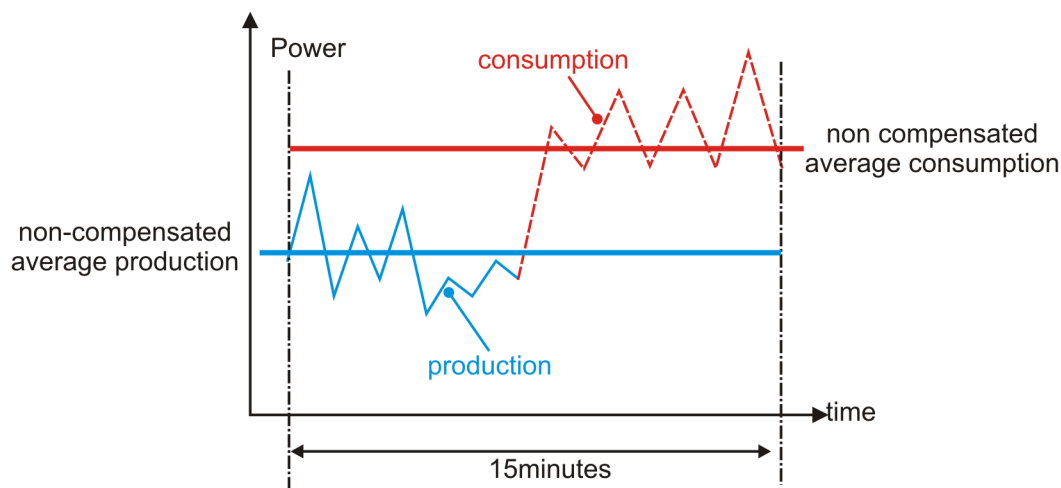

Figure 3 Non-compensated values



Compensated values are the difference between the power produced and consumed during the value period. One of them will be reduced to zero.

Compensated values are labelled "C" in a message.

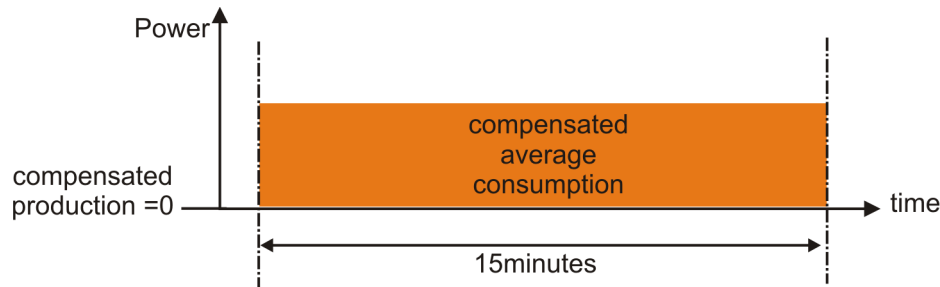

Figure 4 Compensated values

Compensated values are used for billing purposes.

In case of specific corrections due to SDR activations (for example), the Compensated values can be replaced by Compensated Corrected values.

Compensated Corrected values are labelled "CC" in a message.

#### 1.1.3.2. Units

Regulated messages always contain power values. The unit in which the power values are presented depends on type of power, i.e. active or reactive.

- Active power is expressed in Watts (W), Kilowatts (KW or KWT) and Megawatts (MW).
- Inductive and Capacitive reactive power is expressed in Volt-Amperes-reactive (VAR), Kilo Volt-Amperes-Reactive (KVAR or KVR) and Mega Volt-Amperes-Reactive (MVAR).

Non-regulated metering data can contain quantities other than power, and will be labelled with the corresponding unit.

#### 1.1.3.3. Quality

Power values can be measured, calculated or estimated. Every power value in the message is assigned a quality label which can be one of the following:

- N (Normal)

This refers to normal measured values, usually determined by a single properly functioning meter.

- I (Inexact)

Power values may be labelled as inexact for a number of reasons. It may be because there was a perceived problem with the meter, or that values were calculated from combined measurements from several meters, one of which was inexact.

- S (Substitute)

If no measurement is available, an estimated value is used.

Note that the quality of the measured data should not be confused with the *validity* of the message, as described in section 1.2.3.

#### 1.1.3.4. Metering type – Net and Gross

The metering type parameter specifies whether the power values are gross or net. Gross values are determined on the client side, where there is an interest in determining exactly how much power was produced and consumed within a certain period. Elia is concerned with net values.

The distinction between Gross and Net values is illustrated in the Figure below.

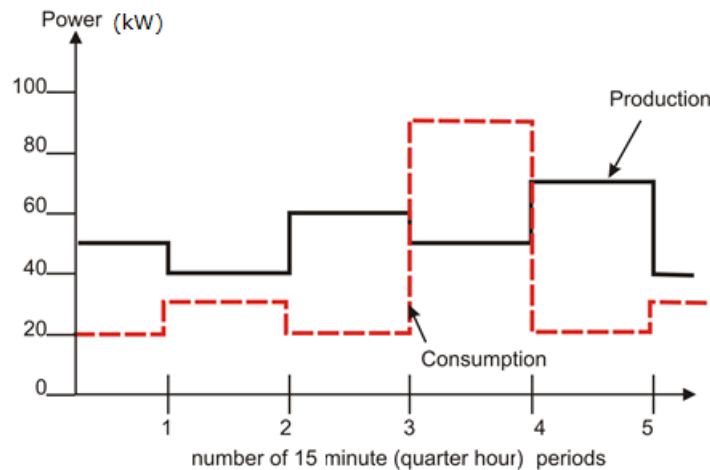

Figure 5 Gross production and consumption values

Periods/Type of consumption	1	2	3	4	5
Gross Consumption	20	30	20	90	20
Gross Production	50	40	60	50	70
Corresponding Net values	30 PROD	10 PROD	40 PROD	40 CONS	50 PROD

Gross power is labelled "G", Net power is labelled "N".

Power can also be defined as "Green Gross" ("GG") (not used at this moment) or "Gross CIPU" ("GC") (total of CIPU units).

## 1.2. Messages

### 1.2.1. Market roles

This section lists each type of clients who have a contractual right to metering information. Clients have different market roles and it is this role that determines the type of messages they receive. A client is identified as the "receiver" of the message.

Frequency delivery and messages received by the clients are defined in section "1.2.8 Regulated messages & message delivery frequency".

#### 1.2.1.1. Grid User (GU)

A Grid User has signed a Connection Contract which grants the right to be connected to the Elia grid. For details on this type of contract, refer to the website Elia:

<https://www.elia.be/en/customers/connection>.

#### 1.2.1.2. Access Contract Holder (ACH)

An Access Contract Holder has a contract allowing offtake or injection of energy at (a) particular Access Point(s). The Access Contract Holder is the party who manages the Access Point and is not necessarily the same as the Grid User for that same point. For details on this type of contract, refer to the website Elia: <https://www.elia.be/en/customers/access>.

### **1.2.1.3. Balance Responsible Party (BRP)**

A Balance Responsible Party is responsible for “nominating” the actual amounts of power injected or taken out of the Elia grid, and for maintaining the balance between injection and consumption into his balance perimeter.

The former name of the BRP is the “ARP” (Access Responsible Party).

Each Access Point must have a Balance Responsible Party associated with it. For details on this BRP role and on this type of contract, refer to the website Elia: <https://www.elia.be/en/electricity-market-and-system/role-of-brp>.

### **1.2.1.4. Supplier (SUP)**

A Supplier provides energy that is injected into the grid. This must be done through a corresponding Balance Responsible Party.

### **1.2.1.5. Producer (PROD)**

A Producer produces energy that is injected into the grid. This must be done through a Supplier.

### **1.2.1.6. Balancing Service provider (BSP) / Flexibility Service Provider (FSP)**

The Balance Service provider (BSP)/ Flexibility Service Provider (FSP) provides Elia with balancing/flexibility services or strategic reserves. This is a generic role given to the signatory of a balancing/flexibility service contract like a mFRR contract or SDR Contract/ DA/ID contract.

### **1.2.1.7. CDS Operator (CDSO)**

A CDSO is a company that operates a Closed Distribution System (CDS).

### **1.2.1.8. Distribution Grid Operator (DGO)**

A Distribution Grid Operator is connected to the Elia grid to distribute energy to end-users and to (re)inject energy from a power plant connected to a distribution grid. The Distribution Grid Operators fall under the authority of regulators in Belgium’s three regions.

### **1.2.1.9. Meter Reading Company (MRCO)**

A Meter Reading Company has a contract with Elia through the corresponding Distribution Grid Operator. Meter Reading Companies receive the same messages sent to the DGOs.

### **1.2.1.10. Metering Contract Holder (MCH)**

A Metering Contract Holder has a contract entitling the holder to receive specific (non-regulated) metering data at specific points. Such a contract is not necessary for clients listed above who will receive metering data as part of the regulatory requirement associated with the contracts they already hold with Elia. Any of the clients listed above can request additional non-regulated metering message. This type of message is described in section "2.3 Metering Point " and the frequency delivery is defined in the Metering Contract. For details on this type of contract, refer to the website Elia: <https://www.elia.be/en/customers/metering/additional-metering-services>.

### **1.2.1.11. Flexibility Data Manager (FDM)**

The System Operator is entrusted the mission of the flexibility data management as specified in Art.19ter of the Electricity Law. In his role of FDM, Elia provides the Supplier and the BSP with the volumes of energy that is both under ToE regime and delivered on request of Elia in the framework of the manual Frequency Restoration Reserve.

## **1.2.2. Message types**

The type of messages a client receives depends on the nature of the contract that is held with Elia and the “role” of the client. An overview of the message type by role is available at section 1.2.8. Elia delivers the following message types to its clients:

### **1.2.2.1. Access Point (AP)**

These messages contain power flow values (aggregated metering data) at specific Access Points. These messages are described in more detail in section "2.1 Access Point”.

Note : The Offshore Interconnection Point is a special Access Point.

#### **1.2.2.2. Service Point (SP)**

These messages contain power flow values at specific Service Point. The service can be Strategic Demand Reserve (SDR), mFRR DP<sub>PG</sub>, DA/ID or other services provided to Elia within the framework of balancing, flexibility or strategic reserves. These messages are described in more detail in section "2.2 Service Point".

#### **1.2.2.3. Metering Point (MP)**

These messages can contain:

- Specific metering data requested by a client and defined in a metering contract. They can contain electric or non-electric data and refer to a specific Access Point.
- Metering data of an individual meter. Usually, these individual meters are used to calculate an aggregation like an Access Point, a Service Point, etc.

A description can be found in more detail in section 2.3.

#### **1.2.2.4. CDS Access Point (CDS AP)**

These messages contain power transfer values at specific CDS Access Points (Access point into a Closed Distribution System). These messages are described in more detail in section "2.4.2 Accessing CDS Access Point messages".

#### **1.2.2.5. CDS Loop losses (PBO)**

These messages contain metering data destined to the CDS Operator. These messages contain the calculation and the components of the loop losses (PBO) of the CDS network for a given month. These messages are described in more detail in section 0.

#### **1.2.2.6. Infeed TSO per substation**

These messages contain power flow values between a TSO (Elia) substation and the Distribution Grid Operator(s) (DGO). Each message refers to a single substation and a corresponding DGO Border Point. These messages are described in more detail in section 0.

#### **1.2.2.7. Infeed TSO per substation and per supply bay**

These messages contain power flow values between a TSO (Elia) substation and a Distribution Grid Operator on a specific supply bay (a trunk or a transformer for example), also known as the DGO Connection Point (DGOCP). Each message refers to a single substation and a corresponding DGO Border Point. These messages are described in more detail in section 2.7.

#### **1.2.2.8. Global Elia Metered Position (GEMP)**

These messages provide aggregated data destined to the BRP. The data is summed nationally over Belgium, over each regulated region and over each regulated region per Supplier. These messages are described in more detail in section 2.8.

#### **1.2.2.9. Imbalance**

These messages contain metering data destined to the BRP and contain the Imbalance of his perimeter for a given month. These messages are described in more detail in section 2.9.

#### **1.2.2.10. Transfer of Energy (ToE) Delivered volume (ToE Del)**

These messages contain the volume delivered (only by DP<sub>PG</sub> delivery points (former non CIPU) with a Transfer of Energy regime) by a BSP/FSP in the framework of the mFRR & DA/ID service. The former name of this type of publications was "mFRR Del". These messages are described in more detail in section 2.10.

Note: The former messages mFRR non CIPU (DP<sub>PG</sub>) delivered volume (mFRR Del) are deprecated and are not published anymore.

#### **1.2.2.11. RT DGO Allocation**

These messages contain an estimate of the DGO Allocation destined to the BRP. These messages are described in more detail in section 0.

#### **1.2.2.12. DGO Border Point and Supply Bay metering**

These messages contain power flow values between a TSO (Elia) substation and a Distribution Grid Operator (DGO) on the supply bays, also known as the DGO Connection Point (DGOCP), and on the

corresponding DGO Border Point. Each message refers to a single substation and a corresponding DGO Border Point. These messages are described in more detail in section 2.12.

#### **1.2.2.13. Delta TS Report**

These messages contain power flow values between the TSO (Elia) and the Distribution Grid Operator(s) (DGO) at the DGO Border point, at the DGO Interconnection Point and provides the difference between the energy measured by Elia at a Border Point (4.1) and the sum of the energy reported by DGO at the DGO Interconnection Points (4.2) linked to the Border Point. These messages are described in more detail in section 2.13.

#### **1.2.2.14. Delta DGO Exchanges (DGO2DGO) report**

These messages contain power flow values measured by each of the DGO in a given DGO exchange point (DGO2DGO) and provides the difference between the energy measured by each of the DGO for a given DGO exchange point (DGO2DGO). These messages are described in more detail in section 2.14.

#### **1.2.2.15. DGO Loop Losses (DGO PBO) report**

These messages contain the result of the allocation control, i.e. the checks that volumes allocated by DGO on a quarter-hourly basis actually correspond to offtakes/injections on the Elia grid. These messages are described in more detail in section 0.

#### **1.2.2.16. Flexibility volumes for BSP or for SUP**

These messages contain flexibility volumes delivered on request of Elia in the framework of mFRR

- aggregated by 1/4h and by Supplier (for the BSP)
- or aggregated by 1/4h and by BSP (for the Supplier).

These messages facilitate the financial compensation required in the case a Transfer of Energy (ToE) applies.

Note : These messages are not described in this document. The related documentation is to find on the website of Synergrid: [http://www.synergrid.be/download.cfm?fileId=C8\\_05\\_FR\\_20180601.pdf](http://www.synergrid.be/download.cfm?fileId=C8_05_FR_20180601.pdf).

#### **1.2.2.17. DGO Reactive Area and Supply Bay metering**

These messages contain power flow values between a TSO (Elia) substation and a Distribution Grid Operator aggregated at the level of a 'Reactive Area'<sup>1</sup> as well as on each supply bay linked to the DGO Reactive Area. Each message refers to a single Reactive Area and the corresponding supply bays. These messages are described in more detail in section 2.16.

### **1.2.3. Message validity**

The initial metering message received by a client contains non-validated data. This should not be confused with the quality of the data – for even if all power values are labelled as normal (N) this does not yet mean that they are validated. The validity of the data applies to the complete set of values in the schedule. Data is validated by processes and checks carried out by Elia. When message is validated, the values are guaranteed to be correct by Elia.

### **1.2.4. Message delivery**

The power values transferred over the quarter hour periods are delivered regularly; daily and/or monthly. This pattern applies to all regulated messages.

#### **1.2.4.1. Daily delivered messages**

A message containing all the quarter hour power values for the current month is delivered by 8h each day. The day on which the message is sent is termed the "publication day". The values for the day(s) for and after the "publication day" are set as 0 (quality flag "Inexact")

So in Figure 6 below, values for all days before Day 2 are published on Day 2.

---

<sup>1</sup> Electrical zone of the network defined by Elia

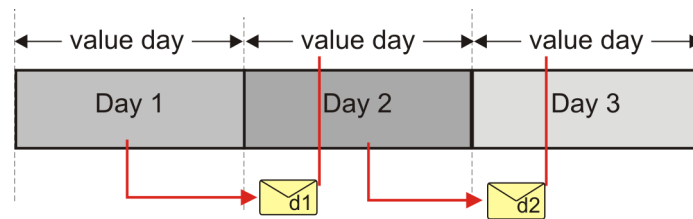

Figure 6 Daily delivery of metering messages

These messages contain non-validated data.

The deliveries are listed in section "1.2.8 Regulated messages & message delivery frequency".

#### 1.2.4.2. Monthly validated delivered messages

The delivery of monthly validated messages is illustrated in Figure 7 below.

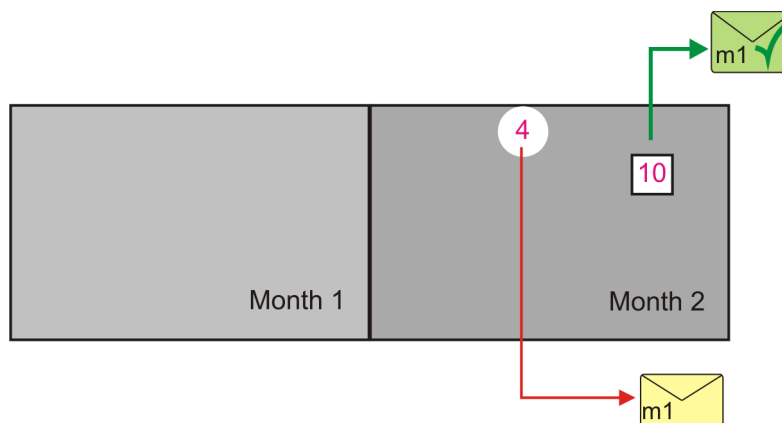

Figure 7 Regular deliveries of monthly messages

No corrections will be issued after the data has been flagged "validated by Elia".

The day of the delivery of validated messages are listed in section "1.2.8 Regulated messages & message delivery frequency".

#### 1.2.5. Accessing messages – protocols

Messages can be delivered using the SFTP protocol or an "EVMSB2C" webpage.

Section 6.1 contains an explanation of these protocols and provides a reference section for the development of applications to receive metering data messages.

#### 1.2.6. Accessing messages – formats

Messages are delivered in CSV, XML or Excel (XLSX) formats. The format in which the messages are delivered is defined in the client contract, and can be switched if required.

Understanding the contents of messages is explained in Chapter 2 on "Understanding messages". Full details on the structure of CSV messages are given in Chapter 3. Full details on the structure of XML message formats are given in Chapter 4 and full details on the structure of XLSX message formats are given in Chapter 5.

#### 1.2.7. Message formats and protocols independency

The format of messages and the protocols are independent. Technically, it is therefore possible to receive any format type using any protocol. However some combinations are not advised (see Elia Metering web page: <https://www.elia.be/en/customers/customer-tools-and-extranet/metering>).

Only one format can be provided per protocol but 2 different formats can be furnished on different protocols.

Example: It is possible to receive the Excel format on EVMSB2C and the XML format on sFTP. This way allows the clients to check in a friendly way the values treated by his own application,

More information about the messages formats in Chapter 3, Chapter 4, Chapter 5 and protocols in Chapter 6.

### **1.2.8. Regulated messages & message delivery frequency**

Table 1 lists all the client roles, the corresponding regulated messages they can receive and their delivery frequency.

Explanation of abbreviations used in the table 1 :

- CD = Calendar Day
- WD = Work day
- 4<sup>th</sup>WD-1 = The calendar day before the 4<sup>th</sup> work day (included)
- 10<sup>th</sup>WD-1 = The calendar day before the 10<sup>th</sup> work day (included)
- Previous month: metering of the previous month sent (back) the current month

Role	Message Type		Message publication frequency	
		page	Non-validated (Intermediate)	Validated (Final)
GU	Access Point	25	Previous month is published from 1 <sup>st</sup> to 9 <sup>th</sup> CD Current month is published every day	Previous month is published on the 10 <sup>th</sup> CD
	CDS Access Point	31	Previous month is published from 1 <sup>st</sup> to 9 <sup>th</sup> CD Current month is published every day	N/A
	Service Point	28	Previous month is published from 1 <sup>st</sup> to 9 <sup>th</sup> CD Current month is published every day	Previous month is published on the 10 <sup>th</sup> CD
	Metering Point	29	Previous month is published from 1 <sup>st</sup> to 9 <sup>th</sup> CD Current month is published every day	Previous month is published on the 10 <sup>th</sup> CD
	Offshore Interconnection Point	25	Previous month is published from 1 <sup>st</sup> to 9 <sup>th</sup> CD Current month is published every day	Previous month is published on the 10 <sup>th</sup> CD
ACH	Access Point	25	Previous month is published from 1 <sup>st</sup> to 9 <sup>th</sup> CD Current month is published every day	Previous month is published on the 10 <sup>th</sup> CD
BRP	Access Point	25	Previous month is published from 1 <sup>st</sup> to 9 <sup>th</sup> CD Current month is published every day	Previous month is published on the 10 <sup>th</sup> CD
	GEMP	51	Previous month is published from 1 <sup>st</sup> to 9 <sup>th</sup> CD Current month is published every day	Previous month is published on the 10 <sup>th</sup> CD
	CDS Access Point	33	Previous month is published from 1 <sup>st</sup> to 10 <sup>th</sup> WD-1 Current month is published every day	Previous month is published on the 10 <sup>th</sup> WD
	Imbalance	56	N/A	Together with invoicing
	RT DGO Allocation	73	Previous month is published the 4 first quarter-hours (till 1 AM) of the 1 <sup>st</sup> CD Current month is published every quarter-hour	N/A
	Offshore Interconnection Point		Previous month is published from 1 <sup>st</sup> to 9 <sup>th</sup> CD Current month is published every day	Previous month is published on the 10 <sup>th</sup> CD
SUP	Access Point	25	Previous month is published from 1 <sup>st</sup> to 9 <sup>th</sup> CD Current month is published every day	Previous month is published on the 10 <sup>th</sup> CD



Role	Message Type		Message publication frequency	
		page	Non-validated (Intermediate)	Validated (Final)
	CDS Access Point	33	Previous month is published from 1 <sup>st</sup> to 10 <sup>th</sup> WD-1 Current month is published every day	Previous month is published on the 10 <sup>th</sup> WD
PROD	Access Point	25	N/A	Previous month is published on the 10 <sup>th</sup> CD
	Metering Point	29	N/A	Previous month is published on the 10 <sup>th</sup> CD
BSP/FSP	Access Point	25	Previous month is published from 1 <sup>st</sup> to 9 <sup>th</sup> CD Current month is published every day	Previous month is published on the 10 <sup>th</sup> CD
	Service Point	28	Previous month is published from 1 <sup>st</sup> to 10 <sup>th</sup> WD Current month is published every day	N/A
	CDS Access Point	33	Previous month is published from 1 <sup>st</sup> to 10 <sup>th</sup> WD Current month is published every day	N/A
	Metering Point	29	Previous month is published from 1 <sup>st</sup> to 10 <sup>th</sup> WD Current month is published every day	N/A
	Transfer of Energy (ToE) Delivered volumes (mFRR DP <sub>PG</sub> & DA/ID)		On event : Previous month is published on 15 <sup>th</sup> WD	Together with Imbalance invoicing
CDSO	Access Point	25	Previous month is published from 1 <sup>st</sup> to 9 <sup>th</sup> CD Current month is published every day	Previous month is published on the 10 <sup>th</sup> CD
	CDS Access Point	33	Previous month is published from 1 <sup>st</sup> to 10 <sup>th</sup> WD Current month is published every day	N/A
	Service Point	28	Previous month is published from 1 <sup>st</sup> to 10 <sup>th</sup> WD Current month is published every day	N/A
	CDS Loop Losses (PBO)	37	Previous month is published from 1 <sup>st</sup> to 16 <sup>th</sup> WD-1 Current month is published every day	Previous month is published on the 16 <sup>th</sup> WD

Role	Message Type	Message publication frequency		
		page	Non-validated (Intermediate)	Validated (Final)
MRCO	Infeed TSO per substation Infeed TSO per substation and per Supply bay	43	Previous month is published from 1 <sup>st</sup> to 4 <sup>th</sup> WD -1 Current month is published every day	Previous month is published on the 4 <sup>th</sup> WD
DGO	Infeed TSO per substation Infeed TSO per substation and per Supply bay	43	Previous month is published from 1 <sup>st</sup> to 4 <sup>th</sup> WD -1 Current month is published every day	Previous month is published on the 4 <sup>th</sup> WD
	DGO Border Point and Supply Bay	80	Previous month is published from 1 <sup>st</sup> to 4 <sup>th</sup> WD -1 Current month is published every day	Previous month is published on the 4 <sup>th</sup> WD
	DGO Loop Losses (DGO PBO) report	93	Previous month is published from 10 <sup>st</sup> WD to 20 <sup>th</sup> WD -1 Current month is published every day	Previous month is published on the 20 <sup>th</sup> WD
	Delta TS Report	84	Previous month is published from 2 <sup>Wst</sup> to 15 <sup>th</sup> WD-1 Current month is published every day	Previous month is published on the 15 <sup>th</sup> WD
	Delta DGO Exchanges (DGO2DGO) report	88	Previous month is published from 5 <sup>st</sup> WD to 15 <sup>th</sup> WD-1 Current month is published every day	Previous month is published on the 15 <sup>th</sup> WD
	DGO Reactive Area and Supply Bay (DGO RA)	98	N/A	Previous month is published the 4 <sup>th</sup> WD
MRCO	DGO Border Point and Supply Bay	80	Previous month is published from 1 <sup>st</sup> to 4 <sup>th</sup> WD -1 Current month is published every day	Previous month is published on the 4 <sup>th</sup> WD

Role	Message Type	Message publication frequency	
		page	
MCH	(Non-regulated) Metering Point	29	Depends on the Client's needs

*Table 1 Message delivery frequency*

### 1.3. Related documents

More info about metering services is available from the Elia website:

- General metering page:

<https://www.elia.be/en/customers/metering>

- System Services:

<https://www.elia.be/en/electricity-market-and-system/system-services>

- Customers:

<https://www.elia.be/en/customers>

- Technical information, documentations, links,... :

<https://www.elia.be/en/customers/customer-tools-and-extranet/metering>

For any other information please contact your Elia Key Account Manager or Metering services (email: [Metering.Services@elia.be](mailto:Metering.Services@elia.be))

## Chapter 2 Understanding messages

This chapter describes the structure of metering message types. It describes how the parameters and type of metered data introduced in Chapter 1 are incorporated into the messages and is targeted principally at operational staff.

**Note:** All the client roles, the corresponding messages types they can receive and delivery frequency of the messages is summarized at section "1.2.8 Regulated messages & message delivery frequency".

### 2.1. Access Point

An Access Point (AP) corresponds to an Injection and/or Offtake Point to the Elia Grid. Every Access Point is associated with one or more meter(s).

Clients receive messages containing the aggregated metering data values for each Access Point specified in their contracts with Elia.

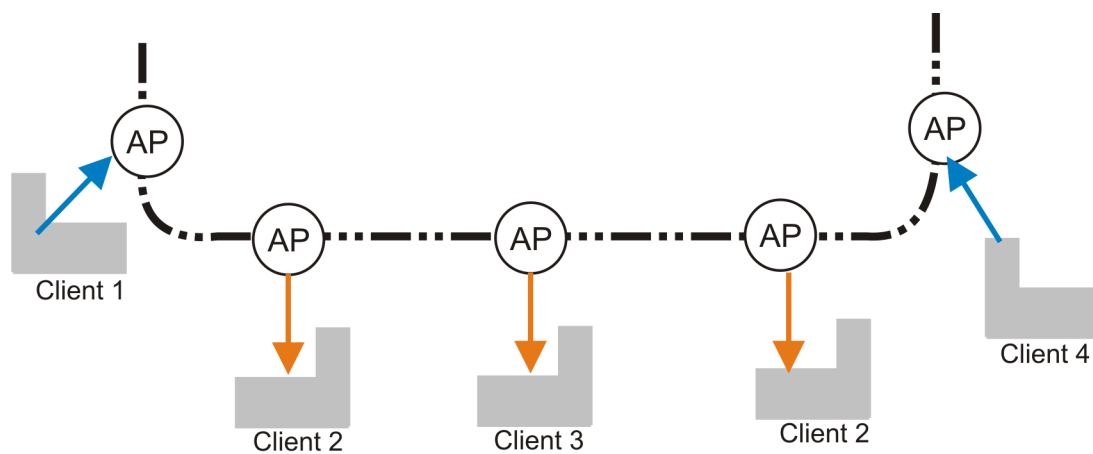

Figure 8 Access Points

Access Point messages are received by clients who can be producers or consumers of energy, or both. The direction of the energy flow is indicated in the message and the values are always positive. These messages identify the client, the Access Point, and all the parameters describing the power transferred as well as the actual power values.

All of the parameters used to describe power values are explained in section 1.1.

Note: The Offshore Interconnection Point has the same format as the Access Point.

#### 2.1.1. Recipients

The recipients and delivery frequency of the Access Point is summarized at section "1.2.8 Regulated messages & message delivery frequency".

#### 2.1.2. Accessing Access Point messages

Access Points messages are regulated messages and delivered on a daily (non-validated) or a monthly (validated) frequency. The delivery schedule for regulated messages is described in section 1.2.4.

More information on accessing messages is given in Chapter 6.

#### 2.1.3. Message content

Access Point messages identify the client, the Access Point, the time period, all the parameters used to describe the power values and the actual power values. This message content can be delivered in one of three formats: CSV described in section 2.1.3.1 below, XML format described in section 2.1.3.2 and Excel (XLSX) format described in section 2.1.3.3.

### 2.1.3.1. CSV Access Point

Access Point messages contain a [header] row, a [data] row, [schedule] sections and an [end] row. An example of a CSV Access Point message is shown below.

```
[header];10X1001A1001A094;22XXXXXXXXXXXXXC;2005-06-08T06:03:17+02:00
[data];10X1001A1001A094;CONS;541453105585999982
[schedule];2005-06-06T22:00:00Z;1440;15;A;N;NC;ALP;W;False; 0;N; 0;N; 0;N;
0;N; 0;N; 0;N; 0;N; 0;N; 0;N; 0;N; 0;N; 0;N; 0;N; 0;N; 0;N; 0;N; 0;N;
0;N; 0;N; 0;N; 0;N; 0;N; 0;N; 0;N; 0;N; 0;N; 0;N; 0;N; 0;N; 0;N;
0;N; 0;N; 0;N; 0;N; 0;N; 0;N; 0;N; 0;N; 0;N; 0;N; 0;N; 0;N; 0;N;
.
.
0;N; 0;N; 0;N; 0;N; 0;N; 0;N; 0;N; 0;N; 0;N; 0;N; 0;N; 0;N; 0;N;
0;N; 0;N; 0;N
[end]
```

Example 1 CSV Access Point message

#### 2.1.3.1.1. [header]

The [header] row contains information about the sender and the receiver of the message as well as the time of creation of the message. There is only one [header] row in the message. For a complete description of all the [header] fields see section 3.1.1.1.

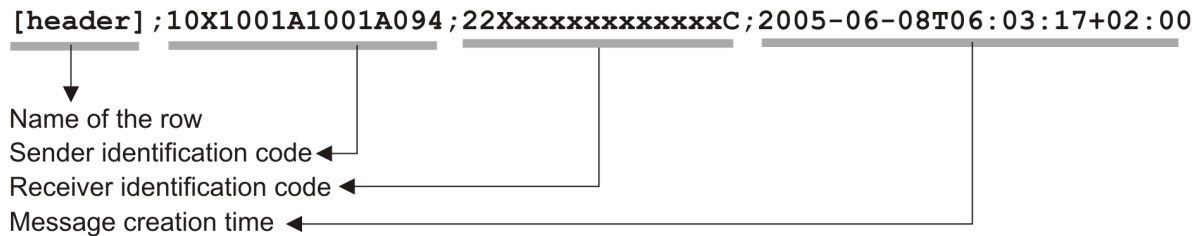

#### 2.1.3.1.2. [data]

A [data] row contains information about metering values. A [data] section is always followed by at least one [schedule] section. There can be several [data] sections that correspond to different directions. The [data] section identifies the source of the metering data, the direction in which the power flows and the Access Point. For a complete description of all the [data] see section 3.1.1.2.

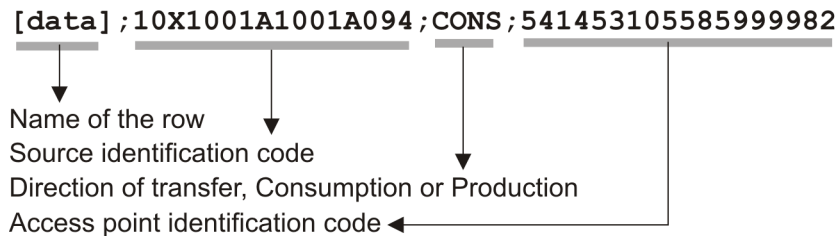

Many [data] rows may be used for different schedules

#### 2.1.3.1.3. [schedule]

A [schedule] section contains the actual power values transferred over the specified time period and identifies the type of power. For any one Access Point (identified in the [data] section) there can be a number of [schedules], those distinguishing the separate transfer of Active and Inductive power for example. The fields contained in the [schedule] are listed below; the general meaning of these fields can be found in section 1.1 and details of all their possible values can be found in section 3.1.1.3.

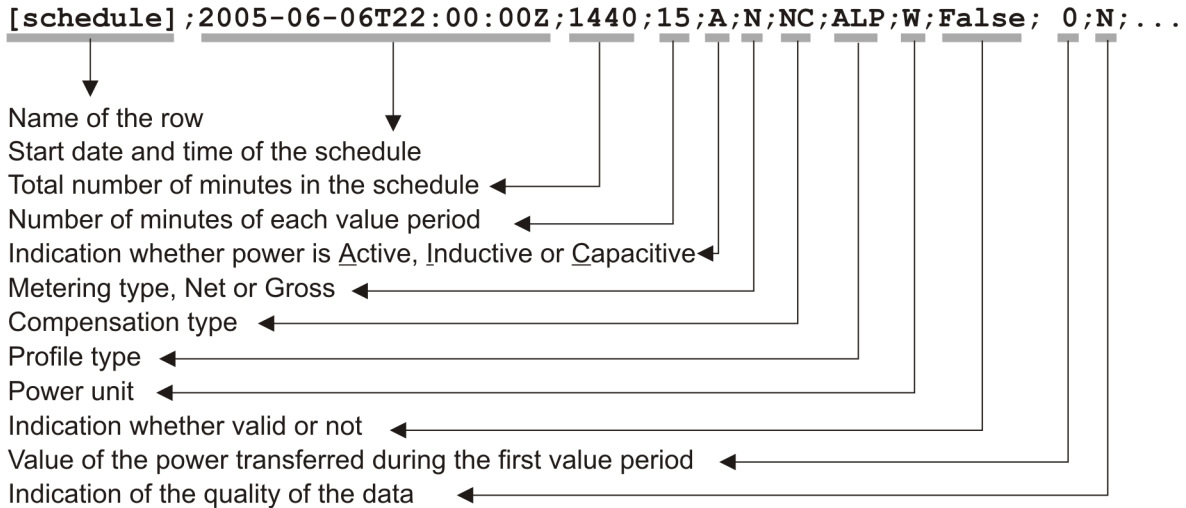

### 2.1.3.2. XML Access Point

Access Point metering data is delivered in an XML file with the root element <AccessPointValues>

```
<?xml version="1.0" encoding="iso-8859-1"?>
<AccessPointValues xmlns="http://www.elia.be/namespaces/public/evms/b2bmsg">
+ <header>
+ <data-list >
</AccessPointValues>
```

*Example 2 XML Access Point message root*

The single <header> element contains information about the sender of the message (Elia) and the receiver as well as the time when the message was created.

```
<header>
+ <sender> (contains fields identifying the sender)
+ <receiver> (contains fields identifying the receiver)
<timestamp>2004-02-05T09:31:10Z</timestamp>
</header>
```

*Example 3 XML Access Point message <header>*

The <data-list> can contain one or more <data> element.

```
<data-list>
+ <data>
</data-list>
```

*Example 4 XML Access Point message <data-list>*

The <data > element describes the flow of the power (from and to the parties concerned), the schedule of actual power values and the Access Point.

```
<data>
+ <partyFrom> (fields defining the flow of energy)
+ <partyTo>
<schedule-list>
+ <schedule> (describes the power and the values)
</schedule-list>
+ <point> (contains fields identifying the Access Point)
</data>
```

*Example 5 XML Access Point message <data>*

The general meaning of these fields is given in section 1.1 and a full description of all the fields and the values they can take is given in section 4.2.

### 2.1.3.3. Excel (XLSX) Access Point

The Excel file contains one sheet named from the Access Point EAN code: this sheet contains all information about the Access Point at the given month.

The top rows contain information about the receiver, the Access Point code and name and the time of creation (last update) of the message.

Subsequent area of the sheet is divided into columns:

- The first lines of the columns give information about the metering data (direction of the flow, power type, metering type, compensation type)
- The quarter hourly values give the power value and the quality for the mentioned metering data

A	B	C	D	E	F	G	H	I	J	K
Company										
Meterable	541453167414516216									
Last Update	23-04-2014									
Validation Status	Non validated by Elia									
Meterable type			Outgoing Active Gross	Outgoing Active Net	Incoming Active Gross	Incoming Active Net				
			Compensated Quality	Compensated Quality	Compensated Quality	Compensated Quality				
Monthly energy			0 KWh Invalid	0 KWh Invalid	0 KWh Invalid	0 KWh Invalid				
Quarter hourly values										
Date	From	To	W	W	W	W				
01-01-2015	00:00	00:15	0 I	0 I	0 I	0 I				
01-01-2015	00:15	00:30	0 I	0 I	0 I	0 I				
01-01-2015	00:30	00:45	0 I	0 I	0 I	0 I				
01-01-2015	00:45	01:00	0 I	0 I	0 I	0 I				
01-01-2015	01:00	01:15	0 I	0 I	0 I	0 I				
01-01-2015	01:15	01:30	0 I	0 I	0 I	0 I				
01-01-2015	01:30	01:45	0 I	0 I	0 I	0 I				
01-01-2015	01:45	02:00	0 I	0 I	0 I	0 I				
01-01-2015	02:00	02:15	0 I	0 I	0 I	0 I				
01-01-2015	02:15	02:30	0 I	0 I	0 I	0 I				
01-01-2015	02:30	02:45	0 I	0 I	0 I	0 I				
01-01-2015	02:45	03:00	0 I	0 I	0 I	0 I				
01-01-2015	03:00	03:15	0 I	0 I	0 I	0 I				
01-01-2015	03:15	03:30	0 I	0 I	0 I	0 I				
01-01-2015	03:30	03:45	0 I	0 I	0 I	0 I				
01-01-2015	03:45	04:00	0 I	0 I	0 I	0 I				

Example 6 Excel Access Point message sheet

## 2.2. Service Point

The Service Point (SP) refers to a point:

- within the electrical facilities of a grid user downstream of an Access Point connected to the Elia Grid
- or within a CDS connected to the Elia Grid

from which a flexibility service can be delivered to Elia. Every Service Point is associated with one or more meter(s).

The metering data are published to the flexibility supplier via the generic role of the Balance Service provider (BSP)/Flexibility Service Provider (FSP).

The flexibility service can be:

- Strategic Demand Reserve (SDR)
- mFRR DP<sub>PG</sub> – Previously known as mFRR Non CIPU, R3Flex & R3E
- DA/ID service
- Any future service

All of the parameters used to describe power values are explained in section 1.1.

### 2.2.1. Recipients

The recipients and delivery frequency are summarized at section "1.2.8 Regulated messages & message delivery frequency".

### 2.2.2. Accessing Service Point messages

Service Point messages are regulated messages and delivered on a daily (non-validated) frequency. The delivery schedule for regulated messages is described in section 1.2.4.



More information on accessing messages is given in Chapter 6.

### 2.2.3. Message content

The Service Point message contains the same information as the Metering Point message described in hereafter.

Only the name of the file contains "SP" and not "MP": See "6.44 Metering messages name".

## 2.3. Metering Point

A Metering Point (MP) is a generic message that can be used for two different purposes:

1. The putting at disposal of the metering data coming from one meter (without any aggregation). For example, a local production unit or a connection point.

These Metering Points are provided by Elia at no extra cost to the Grid User and is part of the "standard metering".

2. The putting at disposal of additional data requested specifically by a Grid User and which is specified in a commercial contract between the client and Elia (non-regulated metering).
  - Such data might include:
    - The (physical) energy flow at a given point, like a local production
    - Non-electric values at a virtual point, such as temperature, imbalance, prices, etc.
  - The content of a Metering Point message will therefore depend on the specific requirements of the client. Since they can contain measured quantities other than power, the corresponding unit is provided in the message too. Examples of non-electric units are:
    - Euro per MW (E/MW)
    - Hertz (HRTZ)
    - Cubic Meter per hour (M3/H)
    - GigaJoules per hour (GJ/H)
    - Celsius (°C)

For compatibility reasons, these units are placed in the same fields as the power units.

- Such data are always published into a specific role: MCH (Metering Contract Holder): more information can be obtained from your Key Account Manager or on the Elia website <https://www.elia.be/en/customers/metering/additional-metering-services>

### 2.3.1. Recipients

Metering Point messages are the "general" type of message representing some metering at a location identified by an EAN code.

The recipients and delivery frequency of the Metering Point are summarized at section "1.2.8 Regulated messages & message delivery frequency".

More information on accessing messages is given in Chapter 6.

### 2.3.2. Accessing Metering Point messages

Metering Points messages (regulated messages) are delivered on a daily (non-validated) or a monthly (validated) frequency. The delivery schedule for regulated messages is described in section 1.2.4.

More information on accessing messages is given in Chapter 6.

### 2.3.3. Message content

When non-regulated, the content of Metering Point messages will of course depend on the specifications of the client as set out in the contract. The general structure of the messages follows that of the regulated messages and is set out here.

Metering Point messages are delivered in three formats: CSV described in section 3.3 , XML described in section "4.3 XML Metering Point messages" and XLSX described in section 5.2.

### 2.3.3.1. CSV Metering Point message

The Metering Point message contains a single [header] section, followed by a series of [data] sections, each of which contains a [schedule]. An example of CSV format Metering Point message containing a non-electric [schedule] with negative values (imbalance schedule) is shown below. Because this message contains non-electric data, not all the field used to describe electric power values are relevant and so there are some that are left blank.

```
[header];10X1001A1001A094;22XXXXXXXXXXXX--Z;2007-02-15T07:59:33+01:00
[data];10X1001A1001A094;CONS;541453114157831663
[schedule];2006-12-31T23:00:00Z;1440;15;A;;;ALP;KW;False; 133.6;N; 85.2;N;
95.6;N; 211.2;N;-621.6;N; 164.8;N;-1231.6;N; 150;N; 148.4;N; 203.6;N; 31.2;N;
278;N; 176.8;N; 292.4;N; 344.4;N; 63.6;N; 206;N; 191.2;N; 176;N; 143.6;N;
174.4;N; 123.6;N; 212;N; 24;N;-52;N; 24.8;N; 47.6;N; 32;N; 203.6;N; 13.2;N;-
.8;N;-58.8;N; 402.8;N; 132;N; 131.2;N;-25.2;N;-120.4;N;-8;N;-157.2;N;-
226.8;N;-97.6;N;-148;N;-200;N;-105.6;N;-72.8;N; 27.6;N;-128;N;-253.2;N;-
518;N;-20.4;N; 42.8;N;-37.2;N; 163.6;N;-9.2;N; 342.8;N; 8;N; 2.8;N; 143.6;N;
71.2;N; 250.8;N;-81.6;N; 40;N; 152.4;N;-72.8;N; 7.2;N;-63.2;N;-132;N;-
362.4;N;-615.6;N;-430.8;N;-49.6;N;-96;N; 141.6;N; 51.6;N; 103.2;N; 63.6;N;
144.4;N;-38;N; 17.6;N; 130;N; 172;N; 107.2;N;-24.8;N; 182.8;N; 37.2;N;
148.8;N; 22;N; 147.6;N;-637.2;N; 42.4;N; 852;N; 62.4;N;-281.2;N; 334.4;N;
324.8;N; 223.2;N
[schedule];2007-01-01T23:00:00Z;1440;15;A;;;ALP;KW;False; 231.2;N; 162.4;N;-
1094;N; 182.8;N;-338;N; 281.6;N; 123.2;N; 283.2;N;-411.6;N; 281.6;N; 364;N;
207.6;N; 217.6;N; 101.2;N; 166.4;N; 39.6;N; 117.6;N; 110.8;N;-29.6;N;
16.8;N;-100.4;N; 52;N;-84.8;N;-54.8;N;-536;N;-1352.8;N;-352.4;N;-600.8;N;-
30.8;N;-396;N;-372;N;-44.4;N; 197.6;N;-459.6;N; 239.2;N;-315.6;N; 99.2;N;-
493.6;N;-350.4;N;-165.6;N;-142.4;N; 70.4;N;-98.8;N; 2;N;-247.6;N;-172;N;-
139.2;N;-131.6;N;-334.4;N; 57.6;N; 203.2;N;-3.6;N; 194.4;N;-20;N; 572.8;N;
341.2;N; 176.8;N;-382;N;-240.4;N;-62.8;N; 261.2;N;-46.4;N; 74.8;N;-267.6;N;-
60.4;N;-79.6;N;-182.4;N;-350;N;-280.4;N;-290.8;N;-426.4;N;-31.6;N;-116;N;
188.8;N; 273.6;N; 170.4;N; 17.6;N; 278.4;N;-187.2;N; 219.2;N; 630.4;N; 80;N;-
483.2;N; 204.8;N; 375.2;N; 279.6;N; 352.8;N; 340;N;-542.8;N; 299.2;N; 538;N;
315.6;N; 32;N; 204.8;N; 144;N; 470.8;N
[end]
```

Example 7 CSV Metering Point message

#### 2.3.3.1.1. [header]

The [header] of the message defines the sender and receiver of the message as well as the time of its creation. There is only one [header] row in the message.

**[header];10X1001A1001A094;22XXXXXXXXXXXX--Z;2007-02-15T07:59:33+01:00**

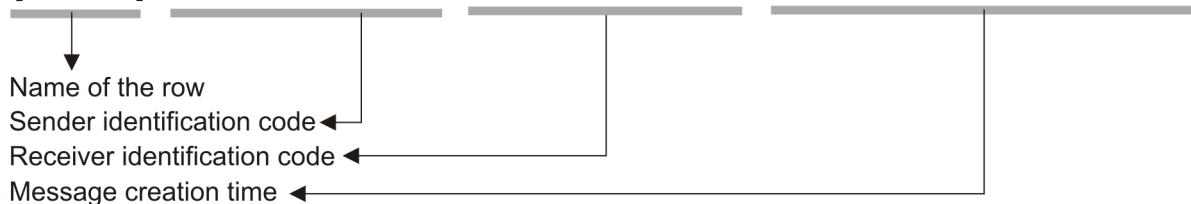

#### 2.3.3.1.2. [data]

Each [data] section identifies the source of the metering data, the direction of the power flow and the access (metering) point to which the data relates.

**[data] ;10X1001A1001A094 ;CONS ;541453114157831663**

↓  
 Name of the row  
 ↓  
 Source identification code  
 ↓  
 Direction of transfer, Consumption or Production  
 ↓  
 Access point identification code

### 2.3.3.1.3. [schedule]

The [schedule] section contains the metered values for the corresponding [data] section. Each [schedule] section identifies all the parameters used to describe the metered quantity as well as the actual metered values. Since Metering Point messages do not necessarily contain power values, some of the fields will be blank.

**[schedule] ;2006-12-31T23:00:00Z;1440;15;A;;;ALP;KW;False;133.6;N;...**

↓  
 Name of the row  
 ↓  
 Start date and time of the schedule  
 ↓  
 Total number of minutes in the schedule  
 ↓  
 Number of minutes of each value period  
 ↓  
 Indication whether power is Active, Inductive or Capacitive  
 ↓  
 Metering type, Net or Gross  
 ↓  
 Compensation type  
 ↓  
 Profile type  
 ↓  
 Power unit  
 ↓  
 Indication whether valid or not  
 ↓  
 Value of the power transferred during the first value period  
 ↓  
 Indication of the quality of the data

Details on all the values that these fields can take are given in section 3.3.

### 2.3.3.2. XML Metering Point message

Metering Point metering data is delivered in an XML file with the root element <MeteringPointValues>

```
<?xml version="1.0" encoding="iso-8859-1"?>
<MeteringPointValues xmlns="http://www.elia.be/namespaces/public/evms/b2bmsg">
+ <header>
+ <data-list >
</MeteringPointValues >
```

*Example 8 XML Metering Point message*

The message consists of a single <header> element that describes the message and a <data-list> element that contains the specific data. Full details on all the fields provided are given in section 4.3.

### 2.3.3.3. Excel (XLSX) Metering Point message

The Excel file contains one sheet named from the EAN code: This sheet contains all information about the Metering Point for the given month:

The top rows contain information about the receiver, the Metering Point code and name and the time of creation (last update) of the message.

Subsequent area of the sheet is divided into columns

The first lines of the columns give information about the metering data (direction of the flow, power type, metering type, compensation type)

The quarter hourly values give the power value and the quality for the mentioned metering data. Because this message may contain non-electric data, not all the field used to describe electric power values are relevant and so there are some that may be left blank.

	A	B	C	D	E	F
1	Company					
2	Meterable	541453138157290220				
3	Last Update	23-04-2014				
4	Validation Status	Non validated by Elia				
5						
6	Meterable type			Incoming		
7				Active		
8				Net		
9				Alternative	Quality	
10	Monthly energy			0 KWh	Invalid	
11						
12	Quarter hourly values					
13	Date	From	To	W		
14	01-01-2015	00:00	00:15	0	I	
15	01-01-2015	00:15	00:30	0	I	
16	01-01-2015	00:30	00:45	0	I	
17	01-01-2015	00:45	01:00	0	I	
18	01-01-2015	01:00	01:15	0	I	
19	01-01-2015	01:15	01:30	0	I	
20	01-01-2015	01:30	01:45	0	I	
21	01-01-2015	01:45	02:00	0	I	
22	01-01-2015	02:00	02:15	0	I	
23	01-01-2015	02:15	02:30	0	I	
24	01-01-2015	02:30	02:45	0	I	
25	01-01-2015	02:45	03:00	0	I	
26	01-01-2015	03:00	03:15	0	I	
27	01-01-2015	03:15	03:30	0	I	
28	01-01-2015	03:30	03:45	0	I	
29	01-01-2015	03:45	04:00	0	I	

Example 9 Excel (XLSX) Metering Point message

## 2.4. CDS Access Point

A 'Closed Distribution System Access Point' or 'CDS Access Point' is the access point to the Closed Distribution System of a Closed Distribution System User, where all its physical Injections and/or Off-takes of Active Power within the Closed Distribution System can be aggregated (virtually if applicable).

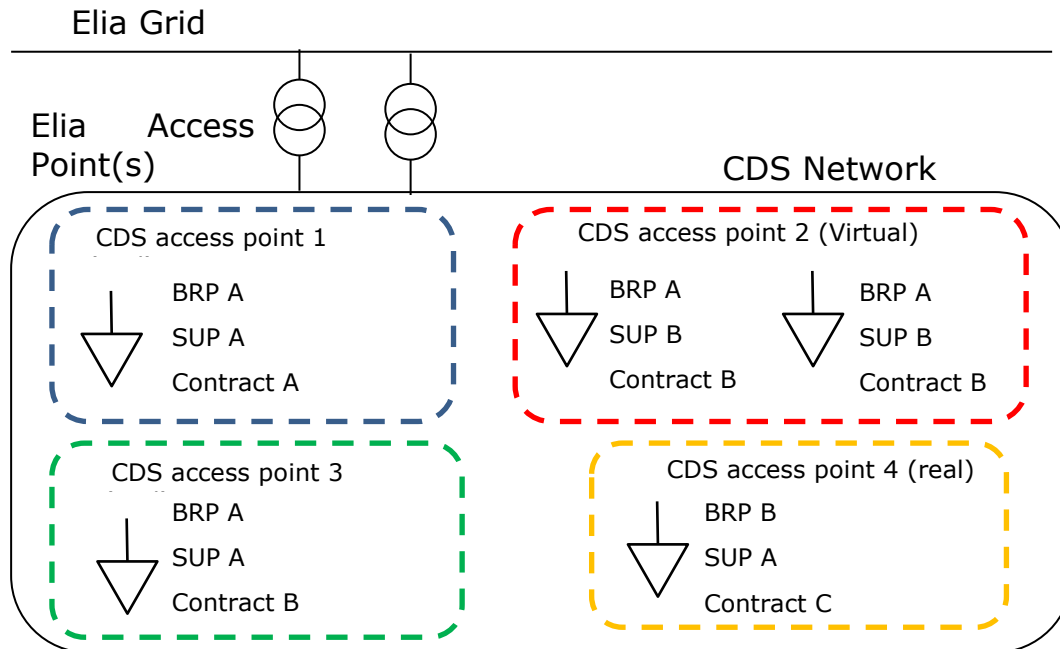

Metering data messages are sent by the CDS Operator to Elia and republished by Elia to the CDS grid user (only in case of real Access Point), BRP, Supplier and BSP according to the contracts of these clients.

### 2.4.1. Recipients

The recipients and delivery frequency of this message is summarized at section "1.2.8 Regulated messages & message delivery frequency" page 19.

### 2.4.2. Accessing CDS Access Point messages

CDS Access Point messages are "regulated" messages and delivered on a daily (non-validated) frequency. The delivery schedule for regulated messages is described in section 1.2.4.

More information on accessing messages is given in chapter Chapter 6.

### 2.4.3. Message content

CDS Access Point messages identify the client, the CDS Access Point, the time period, all the parameters used to describe the power values and the actual power values. They follow the "Metering Point" format.

All of the parameters used to describe power values are explained in section 1.1. Full details on all the descriptive fields and the possible values they can take can be found in:

- section "3.4 CSV CDS Access Point messages" (for the CSV format messages),
- section "4.3 XML Metering Point messages" (for the XML format messages) and
- section "5.2 Excel Metering Point messages" (for the XLSX format messages)

### 2.4.3.1. CSV CDS Access Point message

CDS Access Point messages contain a [header] row, a [data] row and [schedule] sections. An example of a CSV CDS Access Point message is shown below.

```
[header];10X1001A1001A094;22XXXXXXXXXXXX--Z;2007-02-15T07:59:33+01:00
[data];10X1001A1001A094;CONS;541453114157831663
[schedule];2006-12-31T23:00:00Z;1440;15;A;;;ALP;KW;False; 133.6;N; 85.2;N;
95.6;N; 211.2;N;-621.6;N; 164.8;N;-1231.6;N; 150;N; 148.4;N; 203.6;N; 31.2;N;
278;N; 176.8;N; 292.4;N; 344.4;N; 63.6;N; 206;N; 191.2;N; 176;N; 143.6;N;
174.4;N; 123.6;N; 212;N; 24;N;-52;N; 24.8;N; 47.6;N; 32;N; 203.6;N; 13.2;N;-
.8;N;-58.8;N; 402.8;N; 132;N; 131.2;N;-25.2;N;-120.4;N;-8;N;-157.2;N;-
226.8;N;-97.6;N;-148;N;-200;N;-105.6;N;-72.8;N; 27.6;N;-128;N;-253.2;N;-
518;N;-20.4;N; 42.8;N;-37.2;N; 163.6;N;-9.2;N; 342.8;N; 8;N; 2.8;N; 143.6;N;
71.2;N; 250.8;N;-81.6;N; 40;N; 152.4;N;-72.8;N; 7.2;N;-63.2;N;-132;N;-
362.4;N;-615.6;N;-430.8;N;-49.6;N;-96;N; 141.6;N; 51.6;N; 103.2;N; 63.6;N;
144.4;N;-38;N; 17.6;N; 130;N; 172;N; 107.2;N;-24.8;N; 182.8;N; 37.2;N;
148.8;N; 22;N; 147.6;N;-637.2;N; 42.4;N; 852;N; 62.4;N;-281.2;N; 334.4;N;
324.8;N; 223.2;N
[schedule];2007-01-01T23:00:00Z;1440;15;A;;;ALP;KW;False; 231.2;N; 162.4;N;-
1094;N; 182.8;N;-338;N; 281.6;N; 123.2;N; 283.2;N;-411.6;N; 281.6;N; 364;N;
207.6;N; 217.6;N; 101.2;N; 166.4;N; 39.6;N; 117.6;N; 110.8;N;-29.6;N;
16.8;N;-100.4;N; 52;N;-84.8;N;-54.8;N;-536;N;-1352.8;N;-352.4;N;-600.8;N;-
30.8;N;-396;N;-372;N;-44.4;N; 197.6;N;-459.6;N; 239.2;N;-315.6;N; 99.2;N;-
493.6;N;-350.4;N;-165.6;N;-142.4;N; 70.4;N;-98.8;N; 2;N;-247.6;N;-172;N;-
139.2;N;-131.6;N;-334.4;N; 57.6;N; 203.2;N;-3.6;N; 194.4;N;-20;N; 572.8;N;
341.2;N; 176.8;N;-382;N;-240.4;N;-62.8;N; 261.2;N;-46.4;N; 74.8;N;-267.6;N;-
60.4;N;-79.6;N;-182.4;N;-350;N;-280.4;N;-290.8;N;-426.4;N;-31.6;N;-116;N;
188.8;N; 273.6;N; 170.4;N; 17.6;N; 278.4;N;-187.2;N; 219.2;N; 630.4;N; 80;N;-
483.2;N; 204.8;N; 375.2;N; 279.6;N; 352.8;N; 340;N;-542.8;N; 299.2;N; 538;N;
315.6;N; 32;N; 204.8;N; 144;N; 470.8;N
[end]
```

Example 10 CSV CDS Access Point message

#### 2.4.3.1.1. [header]

The [header] of the message defines the sender and receiver of the message as well as the time of its creation. There is only one [header] row in the message.

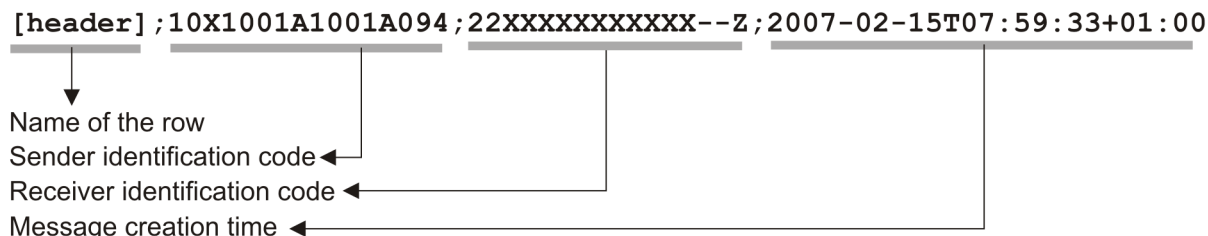

#### 2.4.3.1.2. [data]

Each [data] section identifies the source of the metering data, the direction of the power flow and the access (metering) point to which the data relates.

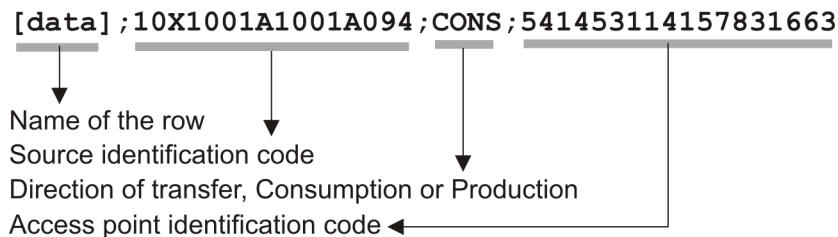

#### 2.4.3.1.3. [schedule]

The [schedule] section contains the metered values for the corresponding [data] section. Each [schedule] section identifies all the parameters used to describe the metered quantity as well as the actual metered values.

**[schedule] ;2006-12-31T23:00:00Z;1440;15;A;;ALP;KW;False;133.6;N;...**

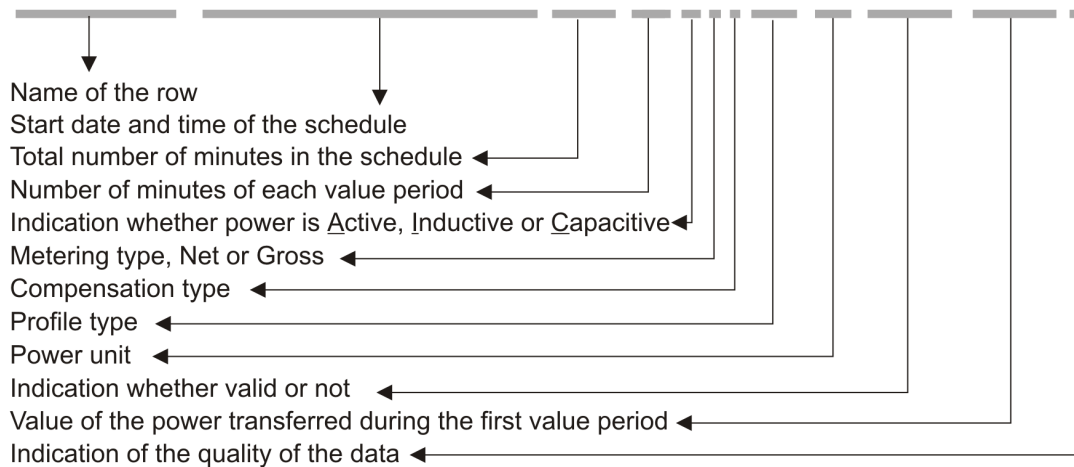

Details on all the values that these fields can take are given in section 3.3.

#### 2.4.3.2. XML CDS Access Point message

Closed Distribution System Access Point metering data is delivered in an XML file with the root element <MeteringPointValues>

```
<?xml version="1.0" encoding="iso-8859-1"?>
<MeteringPointValues xmlns="http://www.elia.be/namespaces/public/evms/b2bmsg">
+ <header>
+ <data-list >
</MeteringPointValues >
```

Example 11 XML CDS Access Point message root

The single <header> element contains information about the sender of the message (Elia) and the receiver as well as the time when the message was created.

```
<header>
+ <sender> (contains fields identifying the sender)
+ <receiver> (contains fields identifying the receiver)
+ <timestamp>2004-02-05T09:31:10Z</timestamp>
</header>
```

Example 12 XML CDS Access Point message <header>

The <data-list> can contain one or more <data> element.

```
<data-list>
+ <data>
</data-list>
```

Example 13 XML CDS Access Point message <data-list>

The <data > element describes the flow of the power (from and to the parties concerned), the schedule of actual power values and the Access Point.

```
<data>
+ <partyFrom> (fields defining the flow of energy)
+ <partyTo>
+ <schedule-list>
+ <schedule> (describes the power and the values)
</schedule-list>
+ <point> (contains fields identifying the Access Point)
</data>
```

Example 14 XML CDS Access Point message <data>

The general meaning of these fields is given in section 1.1 and a full description of all the fields and the values they can take is given in section 4.2.

**2.4.3.3. Excel CDS Access Point message**

The Excel file contains one sheet named from the CDS Access Point EAN code: This sheet contains all information about the CDS Access Point for the given month:

The top rows contain information about the receiver, the CDS Access Point EAN code and name and the time of creation (last update) of the message.

Subsequent area of the sheet is divided into columns

The first lines of the columns give information about the metering data (direction of the flow, power type, metering type, compensation type)

	A	B	C	D	E	F
1	Company					
2	Meterable	541453138157290220				
3	Last Update	23-04-2014				
4	Validation Status	Non validated by Elia				
5						
6	Meterable type			Incoming		
7				Active		
8				Net		
9				Alternative	Quality	
10	Monthly energy			0 KWh	Invalid	
11						
12	Quarter hourly values					
13	Date	From	To	W		
14	01-01-2015	00:00	00:15	0	I	
15	01-01-2015	00:15	00:30	0	I	
16	01-01-2015	00:30	00:45	0	I	
17	01-01-2015	00:45	01:00	0	I	
18	01-01-2015	01:00	01:15	0	I	
19	01-01-2015	01:15	01:30	0	I	
20	01-01-2015	01:30	01:45	0	I	
21	01-01-2015	01:45	02:00	0	I	
22	01-01-2015	02:00	02:15	0	I	
23	01-01-2015	02:15	02:30	0	I	
24	01-01-2015	02:30	02:45	0	I	
25	01-01-2015	02:45	03:00	0	I	
26	01-01-2015	03:00	03:15	0	I	
27	01-01-2015	03:15	03:30	0	I	
28	01-01-2015	03:30	03:45	0	I	
29	01-01-2015	03:45	04:00	0	I	

Example 15 Excel (XLSX) CDS Access Point message



## 2.5. CDS Loop Losses (PBO)

As mentioned in the appendix 14 and 14bis of the Access Contract, Elia controls the allocation data and checks that volumes allocated on a quarter-hourly basis actually correspond to offtakes/injections on the Elia grid.

The result of this allocation control is called "CDS Loop Losses (PBO)" and is actually a kind of "clearing differences". This result is published to the CDS Operator through the "CDS Loop Losses (PBO)" message and the BRP through the "imbalance message" (see 2.9.3.1 "Imbalance components").

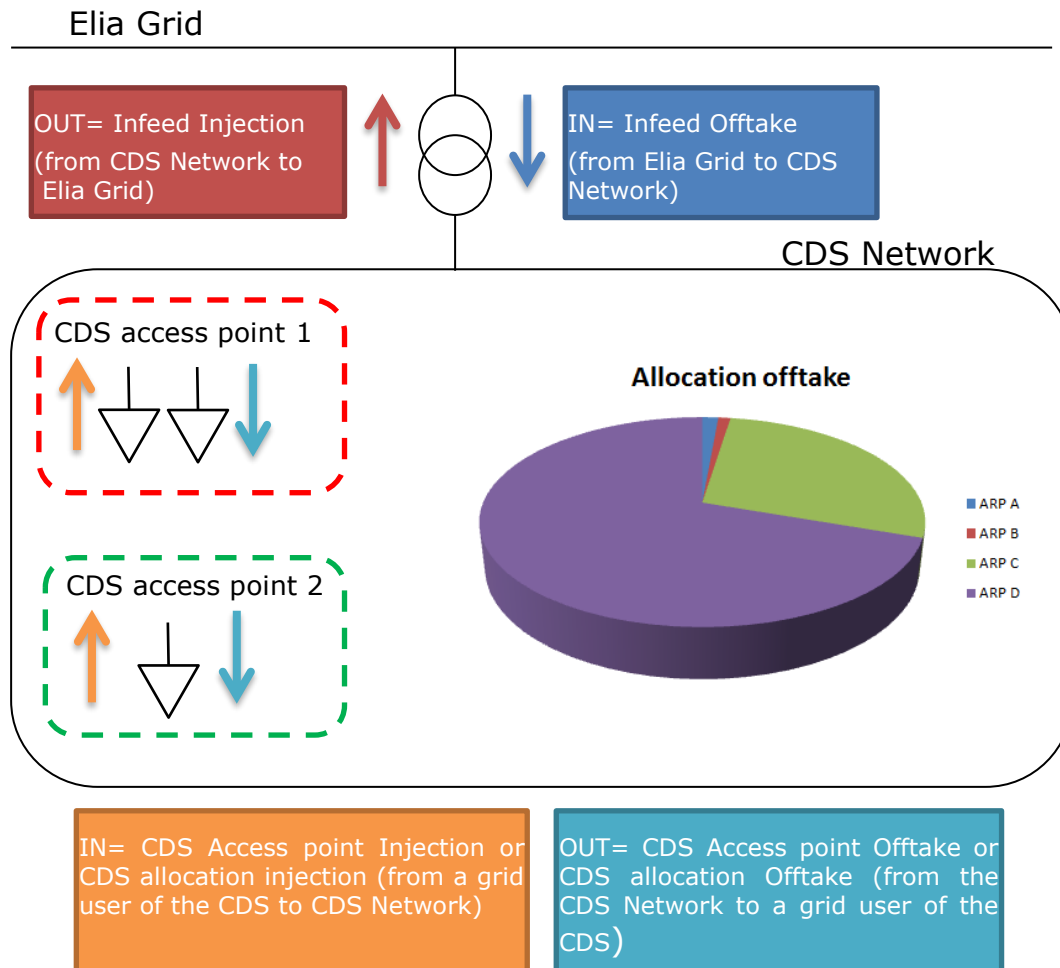

Figure 9: CDS Loop losses (PBO) directions

At the difference of "classical" messages explained before in this document, the "CDS Loop Losses (PBO)" message contains components. A component within a message represents a Business flow. This is the same concept as the components within the Imbalance message (see 2.9.3.1 "Imbalance components").

Each component is supposed well known by the recipient and is published in order to facilitate the analysis in case of error: its detailed business meaning is not described in this document.

The list of possible components is given in "2.5.3.1 CDS Loop Losses (PBO) components".

Each component is considered as having a direction: the section "2.5.3.3 CDS Loop losses (PBO) components added parameters" shows the possible direction with following meaning:

- IN = The energy is coming in the CDS from the Elia Grid or from a grid user of the CDS (through a CDS Access Point)
- OUT = The energy is going out the CDS to the Elia Grid or to a grid user of the CDS (through a CDS Access Point)

Full details on all the descriptive fields and the possible values they can take can be found in section 3.5 (for the CSV format messages) , section 4.4 (for the XML format messages) and section 5.3 (for the XLSX format messages).

### 2.5.1. Recipients

CDS Loop Losses (PBO) messages are regulated messages received by the CDS Operator (CDSO) who receive the components for their CDS Network.

The recipients and delivery frequency of this message is summarized at section "1.2.8 Regulated messages & message delivery frequency".

### 2.5.2. Accessing CDS Loop Losses (PBO) Message

CDS Loop Losses (PBO) messages are "regulated" messages and delivered on a daily (non-validated) frequency. The delivery schedule for regulated messages is described in section 1.2.4.

More information on accessing messages is given in chapter Chapter 6.

### 2.5.3. Message content

CDS Loop Losses (PBO) messages identify the recipient, the time period, all the parameters of each component used to describe the power values. This message content can be delivered in one of three formats: CSV described in section below, XML format (same as metering point) described in section "2.3.3.2 XML Metering Point message " and Excel (XLSX) format described in section "5.2 Excel ".

#### 2.5.3.1. CDS Loop Losses (PBO) components

The business concepts behind each component are explained in the contractual document given to the CDS Operator. This manual gives only a short description.

The CDS Loop Losses (PBO) components that are part of the message:

Component	Description
CDSLoopLosses	Loop losses (PBO) of a CDS Network give the result of the allocation control and is given by the following equation: $\sum \text{direction IN} - \sum \text{direction OUT}$ (of sub components explained here below). This component can have as well positive as negative values.
CDSInfeedOfftakeTotal	Total energy coming from Elia network to CDS network through the Elia Access Points feeding the CDS network
CDSInfeedInjectionTotal	Total energy coming from the CDS network to Elia network through the Elia Access Points feeding the CDS network
CDSAllocationOfftakeTotal	Total of allocations offtake for a CDS Network (OUT = means energy coming from the CDS to the BRP)
CDSAccessPointsOfftakeTotal	Total of the CDS Access Points in the direction Offtake (OUT = energy going out the CDS network to a CDS Grid User) The CDS Access Points defined in the CDS data exchange contract.
CDSAllocationInjectionTotal	Total of allocations injection for a CDS Network (IN = means energy coming from the BRP to the CDS)
CDSAccessPointInjectionTotal	Total of the CDS Access Points in the direction Injection (IN = energy coming in the CDS network form a CDS Grid User) The CDS Access Points defined in the CDS data exchange contract.

#### Remarks:

This list could vary if new components of the CDS Loop Losses (PBO) are identified or some components removed following the contract of the CDS Operator or new market rules.

It is highly recommended that the system that will read the message has not to be based on the order of the components but on the components criteria's explained here below.

### 2.5.3.2. CDS Loop losses (PBO) components criteria

In the following list the columns must be understood as:

- **Component:** See here below
- **Flow direction:** the flow of energy within the CDS: See beginning of this section.
- **Possible negative value?:** Normally the energy follows the flow indicated within the column 'Flow direction' in the table below, but the result of the allocation control can flow in the other direction. In this case, the quarter value is negative.

Component	Flow direction	Possible negative values?
CDSLoopLosses	In	Yes
CDSInfeedOfftakeTotal	In	No
CDSInfeedInjectionTotal	Out	No
CDSAllocationOfftakeTotal	Out	No
CDSAccessPointsOfftakeTotal	Out	No
CDSAllocationInjectionTotal	In	No
CDSAccessPointInjectionTotal	In	No

### 2.5.3.3. CDS Loop losses (PBO) components added parameters

Each component of the CDS Loop Losses (PBO) message concerns the CDS area and refers to its CDS network EAN (these EAN codes are also used in the nomination system).

See [https://www.elia.be/-/media/project/elia/elia-site/customers/customer-tools/metering/4\\_list\\_of\\_eans\\_of\\_closed\\_distribution\\_systems\\_en.pdf](https://www.elia.be/-/media/project/elia/elia-site/customers/customer-tools/metering/4_list_of_eans_of_closed_distribution_systems_en.pdf) for the complete list.

Currently following CDS Networks are available:

541453185522017586 - DNB Brussels Airport \_ Zaventem  
 541453176864035840 - BASF Antwerpen  
 541453173171146450 - ArcelorMittal Belgium \_ Seraing  
 541453118417028657 - ArcelorMittal Belgium \_ Ramet

### 2.5.3.4. CSV CDS Loop Losses (PBO) Value

PBO messages contain a [header] row, a [data] row describing the component, a [schedule] per day and an [end] sections. An example of a CSV CDS Loop Losses (PBO) message is shown below:

```
[header];10X1001A1001A094;22XCDSOPERATOR-4;2015-11-22T23:00:00Z;CDS PBO;10;Final
[data];CDS Total Infeed Offtake;IN;541416004540000143
[schedule];2015-07-31T22:00:00Z;1440;15;A;KW;695939,469;N;542630,839;N;...
[end]
```

*Example 16 CSV CDS Loop losses (PBO) message*

#### 2.5.3.4.1. [header]

The [header] row contains information about the sender and the receiver of the message as well as the time of creation, the version number, state of the message and the fact that this is a CDS Loop Losses (PBO) message. There is only one [header] row in the message. For a complete description of all the [header] fields see section "3.5.1.1 CDS Loop Losses (PBO) [header]".

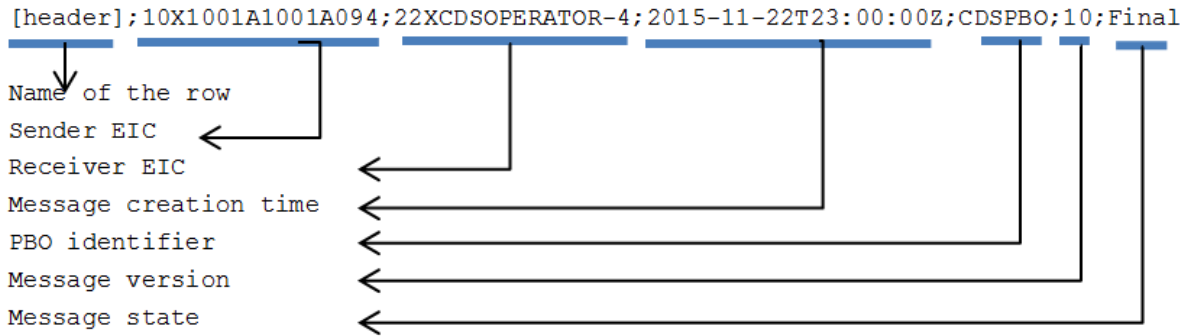

### 2.5.3.4.2. [data]

A [data] row contains information about the component and related criteria's. A [data] section is always followed by at least one [schedule] section. There are several [data] sections that correspond to different components. For a complete description of all the [data] see section "3.5.1.2 CDS Loop Losses (PBO) [data]".

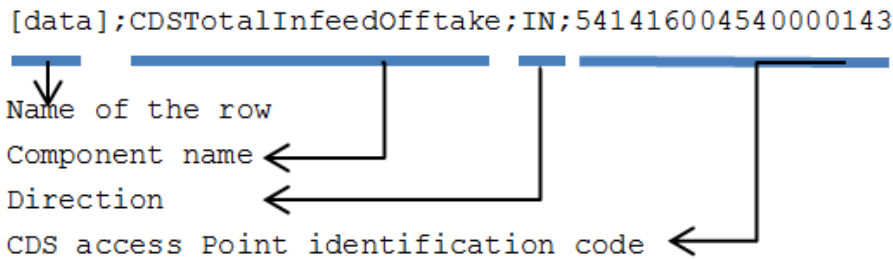

### 2.5.3.4.3. [schedule]

A [schedule] section contains the power values transferred over the specified time period and identifies the type of power. The Time period constitutes 1 day of 23, 24 or 25 hours. For any component identified in the [data] section, there can be a number of [schedules].

The fields contained in the [schedule] are listed below; the general meaning of these fields can be found in section 1.1 and details of all their possible values can be found in section "3.5.1.3 PBO [schedule]".

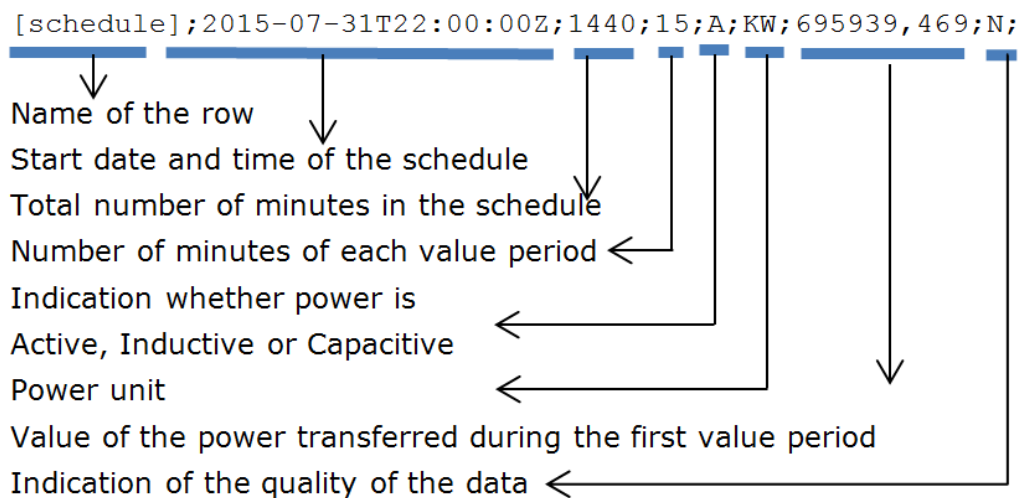

### 2.5.3.5. XML CDS Loop losses (PBO)

The XML CDS Loop Losses (PBO) message has a structure which is completely different of the "Classic" metering messages (as the Access Point).

The Elia goal is to replace in a near future all the Metering XML messages in order to cope with European and worldwide standards that are available now: the current Imbalance message respects the **IEC standard 62325-451-4**.

The structure therefore is briefly explained in this document but whole description is available on the IEC web store: <https://webstore.iec.ch/publication/29116>.

The XSD Schema reference is available on "4.1 Reference XSD".

```
<EnergyAccount_MarketDocument
xsi:schemaLocation="urn:iec62325.351:tc57wg16:451-4:energyaccountdocument:4:0
iec62325-451-4-settlement_v4.xsd" xmlns="urn:iec62325.351:tc57wg16:451-
4:energyaccountdocument:4:0" xmlns:xsi="http://www.w3.org/2001/XMLSchema-
instance">
</EnergyAccount_MarketDocument>
```

*Example 17 XML CDS Loop losses (PBO) message root*

The message begins with information about the sender of the message (Elia) and the receiver as well as the time when the message was created plus some information about the state of this message: This header is valid for all the Time Series.

Technical information on each field is available in "4.4 XML CDS Loop Losses (PBO) messages".

Remark: the XML comments indicated in the message here below are for the reader comprehension and can be not available in the message sent by Elia;

```
<mRID>CDSPBO_20150801_20150831</mRID>
<revisionNumber>10</revisionNumber>
<type>Z01<!--CDS PBO--></type>
<docStatus><value>A02</value><!--Final--></docStatus>
<process.processType>A05</process.processType>
<!--Metered data aggregation-->
<process.classificationType>A01</process.classificationType>
<!--Detail-->
<sender_MarketParticipant.mRID
codingScheme="A01">10X1001A1001A094</sender_MarketParticipant.mRID>
<sender_MarketParticipant.marketRole.type>CDSO</sender_MarketParticipant.mark
etRole.type>
<receiver_MarketParticipant.mRID codingScheme="A01">22XCDSOPERATOR-
4</receiver_MarketParticipant.mRID>
<receiver_MarketParticipant.marketRole.type>Z01</receiver_MarketParticipant.m
arketRole.type> <!--Closed Distribution System Operator-->
<createdDateTime>2015-11-22T23:00:00Z</createdDateTime>
<period.timeInterval><start>2015-07-31T22:00Z</start><end>2015-08-
30T22:00Z</end></period.timeInterval>
<domain.mRID codingScheme="A01">10YBE-----2</domain.mRID><!--domain =
Belgium Area-->
<TimeSeries>
```

*Example 18 XML CDS Loop Losses (PBO) message header*

The <TimeSeries> element describes the flow of the power for one component and related criteria and the schedule of actual power values.

Technical information on each field is described in section "4.4.2 XML CDS Loop Losses (PBO) TimeSeries fields" page 139

```
<TimeSeries>
<mRID>Z01541416004540000143</mRID>
<businessType>Z01</businessType>
<!--IN=loop losses of a CDS Network = direction IN - direction OUT (of
sub components) : the normal case is a IN (the CDS network has received too
much energy and this energy must go to the BRP CDS losses)-->
<product>8716867000016</product>
<objectAggregation>A01</objectAggregation>
<area_Domain.mRID
codingScheme="A01">541416004540000143</area_Domain.mRID>
<measure_Unit.name>KWT</measure_Unit.name>
<Period>
</TimeSeries>
```

*Example 19 XML CDS Loop losses (PBO) message TimeSeries*

The general meaning of these fields is given in section 1.1 and a full description of all the fields and the values they can take is given in section "4.4.2 XML CDS Loop Losses (PBO) TimeSeries fields".

### 2.5.3.6. Excel CDS Loop Losses (PBO) Value

The Excel file contains one sheet named with the EAN code of the CDS network: This sheet contains all information about each component and related criteria's for a given month:

- The top rows contain information about the receiver, the EAN of the CDS network, the status of the message and the time of creation (last update) of the message and the fact that this sheet follow the PBO message format
- Subsequent area of the sheet is divided into columns
- The first lines of the columns give information about the component name, Direction and Power Flow) described in "2.5.3.1 CDS Loop Losses (PBO) components "
- The quarter hourly values give the power value and the quality for the mentioned metering data

	A	B	C	D	E
1	<b>Company</b>	22XCDSOPERATOR-4		<b>CDS Operator Company</b>	
2	<b>Meterable</b>	541416004540000143		<b>CDS Test1</b>	
3	<b>Last Update</b>	23-11-2015		<b>PBO</b>	
4	<b>Status</b>	Final			
5	<b>Version</b>	10			
6					
7	<b>Component Meterable type</b>			<b>CDSTotalInfeedOfftake</b>	
8				IN	
9				Active	
10				Value	Quality
11	Monthly energy			516.064 KWh	Valid
12	Quarter hourly values				
13	Date	From	To	W	
14	01-07-2015	00:00	00:15	521.914	N
15	01-07-2015	00:15	00:30	514.735	N
16	01-07-2015	00:30	00:45	500.378	N
17	01-07-2015	00:45	01:00	494.607	N
18	01-07-2015	01:00	01:15	490.948	N
19	01-07-2015	01:15	01:30	491.089	N
20	01-07-2015	01:30	01:45	502.490	N
21	01-07-2015	01:45	02:00	511.000	N

*Example 20 Excel CDS Loop Losses (PBO) message sheet*

A full description of all the fields and the values they can take is given in section "5.3 Excel CDS Loop Losses (PBO) messages".

## 2.6. Infeed TSO per substation

These messages provide metering information about the power transferred between a TSO (Elia) substation and the Distribution Grid Operator (DGO), also called Distribution System Operator (DSO), connected to this substation. Each message refers to a single substation and its single corresponding DGO Border Point (DGOBP) since it represents the "border" between the Elia Grid and the DGO's Grid.

The number of Interconnection Points (IP) associated with the DGOBP is identified in the message. Each Distribution Grid Operator has a single Interconnection Point to the single Border Point associated with the substation.

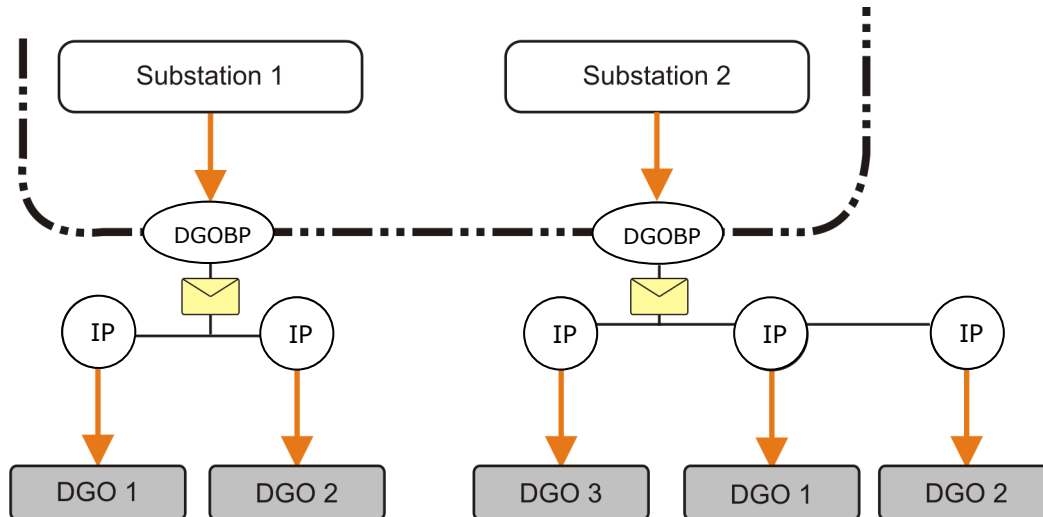

Figure 10 Infeed TSO per substation

The title of the message refers to "infeed", implying a flow from Elia to the DGO, but in fact the power can flow in either direction. The direction is indicated in the 'data' section of the message.

All of the parameters used to describe power values are explained in section 1.1. Full details on all the descriptive fields and the possible values they can take can be found in section 3.2 (for the CSV format messages), section 4.5 (for the XML format messages) and section 5.2 (for the Excel format messages).

### 2.6.1. Recipients

The recipients and delivery frequency of this message is summarized at section "1.2.8 Regulated messages & message delivery frequency " page 19.

### 2.6.2. Accessing Infeed TSO per substation messages

Infeed TSO per substation messages are delivered on a daily or a monthly basis. The delivery schedule for regulated messages is described in "1.2.8 Regulated messages & message delivery frequency " page 19.

More information on accessing messages is given in Chapter 6.

### 2.6.3. Message content

The message contains the data for one calendar month (these have been referred to as xEIN105)

The structure of the message identifies the client, the substation distribution border point, the included Access Points, the time period, all the parameters used to describe the power values and the actual power values. This message content can be delivered in one of three formats; CSV described in section 2.6.3.1 below, XML format described in section 2.6.3.2 and Excel (XLSX) format described in section 2.6.3.3.

### 2.6.3.1. CSV Infeed TSO per substation

Infeed TSO per substation messages contain a <header> row, a <data> row, <schedule> sections and an <end> row. An example of a daily CSV message for 1 distribution point and 1 related Access Point for Inductive power is shown below.

```

<header>;5499770302608;549912345678;2004-06-10T08:18:34+02:00
<data>;5499770302608;CONS;541453111821234567;1;541453133821234566
<schedule>;2004-06-08T22:00:00Z;1440;15;I;ALP;KVR;False;
180;N;120;N;100;N;60;N;60;N;20;N;20;N;20;N;20;N;0;N;0;N;0;N;0;N;0;N;0;N;
0;N;0;N;0;N;0;N;0;N;0;N;0;N;0;N;40;N;160;N;260;N;360;N;460;N;520;
N;580;N;660;N;700;N;700;N;740;N;800;N;720;N;720;N;680;N;700;N;640;N;480;N;440
;N;480;N;660;N;580;N;580;N;520;N;500;N;520;N;480;N;500;N;580;N;640;N;660;N;64
0;N;640;N;680;N;660;N;680;N;660;N;660;N;680;N;620;N;620;N;640;N;620;N;680;N;7
40;N;760;N;740;N;780;N;780;N;760;N;660;N;640;N;600;N;580;N;540;N;460;N;400;N;
380;N;380;N;340;N;340;N;340;N;320;N;380;N;340;N;320;N;300;N;260;N;240;N
<end>
    
```

Example 21 CSV Infeed TSO per substation message

#### 2.6.3.1.1. <header>

The <header> row contains information about the sender, the receiver and the time of creation of the message. There is only one <header> row in the message. For a complete description of all the <header> fields see section 3.6.1.1 on page 112.

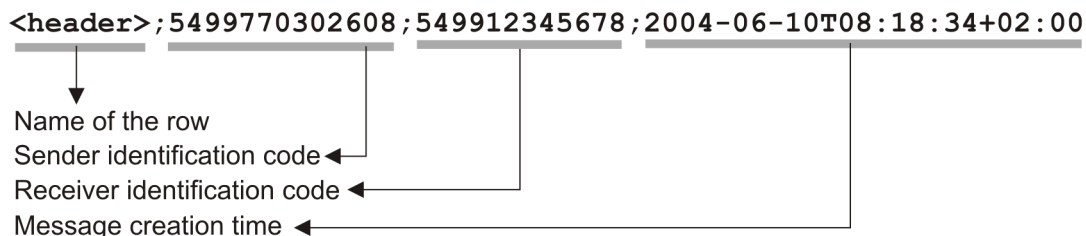

#### 2.6.3.1.2. <data>

A <data> row contains information about all the metering values that are contained in the associated <schedule> section. A <data> section is always followed by at least one <schedule> section. The <data> section identifies the source of the metering data, the direction of flow of the power, the distribution point associated with the substation and the Access Points associated with the DGOB. For a complete description of all the <data> fields see section 3.6.1.2 on page 113.

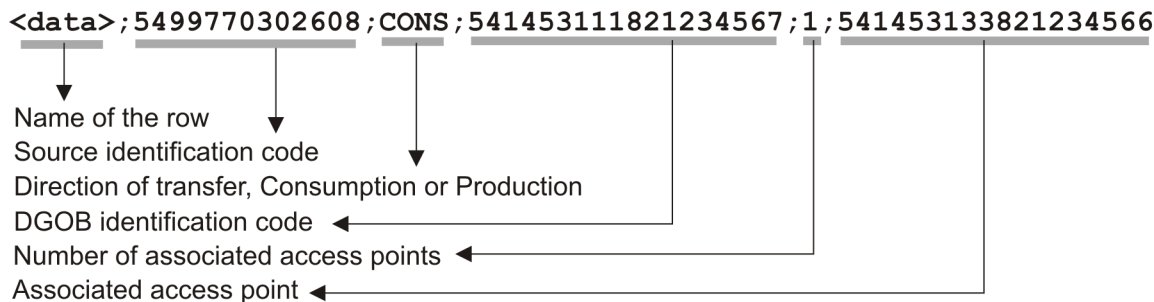

#### 2.6.3.1.3. <schedule>

A <schedule> section contains the actual power values transferred over the specified time period and identifies the type of power. For any one <data> section there can be a number of <schedules>, those distinguishing the separate transfer of Active and Inductive power for example. The fields contained in the <schedule> are listed below. The general meaning of these fields can be found in section 1.1 and details of all their possible values can be found in section 3.6.1.3 on page 113.



```
<schedule>;2004-06-08T22:00:00Z;1440;15;I;ALP;KVR;False;180;N;...
```

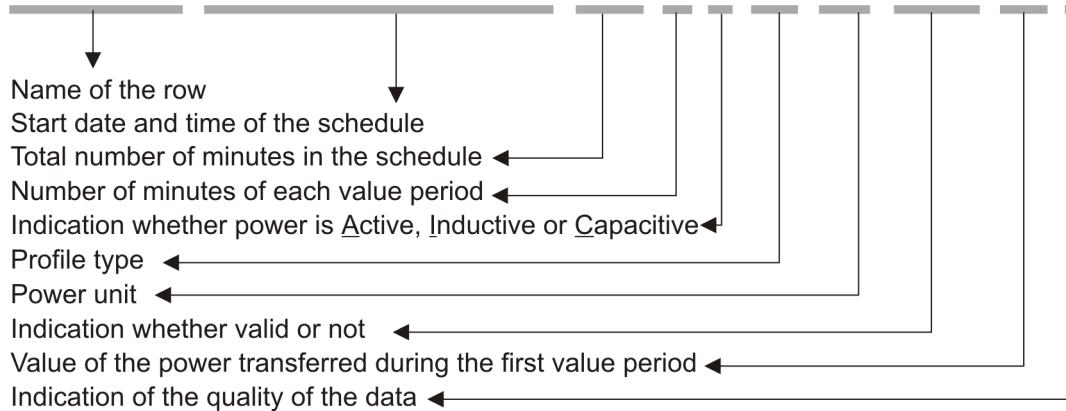

### 2.6.3.2. XML Infeed TSO per substation

The XML Infeed TSO per substation message is a file with a `<BorderPointValues>` root element. The root element contains a `<header>` element and a `<data list>` element.

```
<?xml version="1.0" encoding="iso-8859-1"?>
< BorderPointValues xmlns="http://www.elia.be/namespaces/public/evms/b2bmsg">
+ <header>
+ <data-list>
</ BorderPointValues>
```

*Example 22 XML Infeed TSO per substation message root*

The single `<header>` element contains information about the sender of the message (Elia), the receiver as well as the time when the message was created.

```
<header>
+ <sender> (contains fields identifying the sender)
+ <receiver> (contains fields identifying the receiver)
<timestamp>2004-02-05T09:31:10Z</timestamp>
</header>
```

*Example 23 XML Infeed TSO per substation message <header>*

The `<data-list>` can contain one or more `<data>` element.

```
<data-list>
+ <data>
</data-list>
```

*Example 24 XML Infeed TSO per substation message <data-list>*

The `<data>` element contains information about the flow of the energy (from and to the parties involved). It identifies the substation distribution border point (`<DPEanCode>`), the number of associated Access Points (`<accessPoints-list>`) and a `<schedule-list>` that lists the actual power values.

```
<data-list>
<data>
+ <partyFrom>
+ <partyTo>
+ <schedule-list>
+ <accessPoints-list>
<DPEanCode>1234567899876</DPEanCode>
</data>
</data-list>
```

*Example 25 XML Infeed TSO per substation message <data>*

The general meaning of these fields can be found in section 1.1. A full description of all the fields and the values they can take is given in section 4.3 on page 136.

### 2.6.3.3. Excel Infeed TSO per substation

The Excel file contains one sheet named from the Distribution Point EAN code: this sheet contains all information about the Distribution Point values for the given month.

The top rows contain information about the receiver, the Distribution Point code and name, the time of creation (last update) of the message and the associated Access Point EAN.

Subsequent area of the sheet is divided into columns

The first lines of the columns give information about the metering data (direction of the flow, power type, metering type, compensation type)

The quarter hourly values give the power value and the quality for the mentioned metering data

	A	B	C	D	E	F	G	H	I	J	K	L	M	N	O
1	Company														
2	Meterable	541453113100397584													
3	Last Update	23-04-2014													
4	Validation Status	Non validated by Elia													
5	Associated Access Point EAN	541453117400759455													
6															
7	Meterable type			Outgoing Active Net	Outgoing Capacitive Net	Outgoing Inductive Net	Incoming Active Net	Incoming Capacitive Net	Incoming Inductive Net						
8				Compensated	Quality	Compensated	Quality	Compensated	Quality	Compensated	Quality	Compensated	Quality	Compensated	Quality
9															
10	Monthly energy			0 KWh	Invalid	0 KVARh	Invalid	0 KVARh	Invalid	0 KWh	Invalid	0 KVARh	Invalid	0 KVARh	Invalid
11															
12	Quarter hourly values														
13	Date	From	To	W	VAR	VAR	VAR	W	VAR	VAR	VAR				
14	01-01-2015	00:00	00:15	0	I	0	I	0	I	0	I	0	I	0	I
15	01-01-2015	00:15	00:30	0	I	0	I	0	I	0	I	0	I	0	I
16	01-01-2015	00:30	00:45	0	I	0	I	0	I	0	I	0	I	0	I
17	01-01-2015	00:45	01:00	0	I	0	I	0	I	0	I	0	I	0	I
18	01-01-2015	01:00	01:15	0	I	0	I	0	I	0	I	0	I	0	I
19	01-01-2015	01:15	01:30	0	I	0	I	0	I	0	I	0	I	0	I
20	01-01-2015	01:30	01:45	0	I	0	I	0	I	0	I	0	I	0	I
21	01-01-2015	01:45	02:00	0	I	0	I	0	I	0	I	0	I	0	I
22	01-01-2015	02:00	02:15	0	I	0	I	0	I	0	I	0	I	0	I
23	01-01-2015	02:15	02:30	0	I	0	I	0	I	0	I	0	I	0	I
24	01-01-2015	02:30	02:45	0	I	0	I	0	I	0	I	0	I	0	I
25	01-01-2015	02:45	03:00	0	I	0	I	0	I	0	I	0	I	0	I
26	01-01-2015	03:00	03:15	0	I	0	I	0	I	0	I	0	I	0	I
27	01-01-2015	03:15	03:30	0	I	0	I	0	I	0	I	0	I	0	I
28	01-01-2015	03:30	03:45	0	I	0	I	0	I	0	I	0	I	0	I
29	01-01-2015	03:45	04:00	0	I	0	I	0	I	0	I	0	I	0	I
30	01-01-2015	04:00	04:15	0	I	0	I	0	I	0	I	0	I	0	I
31	01-01-2015	04:15	04:30	0	I	0	I	0	I	0	I	0	I	0	I
32	01-01-2015	04:30	04:45	0	I	0	I	0	I	0	I	0	I	0	I
33	01-01-2015	04:45		0	I	0	I	0	I	0	I	0	I	0	I

Example 26 Excel (XLSX) Infeed TSO per substation message

## 2.7. Infeed TSO per substation and per supply bay

These messages provide metering information about the power transferred between a TSO (Elia) substation and a Distribution Grid Operator on a specific supply bay (a cable or a transformer for example), also known as the DGO Connection Point (DGOCP). Each message refers to a single DGO Connection Point/Supply bay within a substation. It represents the “physical” “border” between the Elia Grid and the DGO’s Grid.

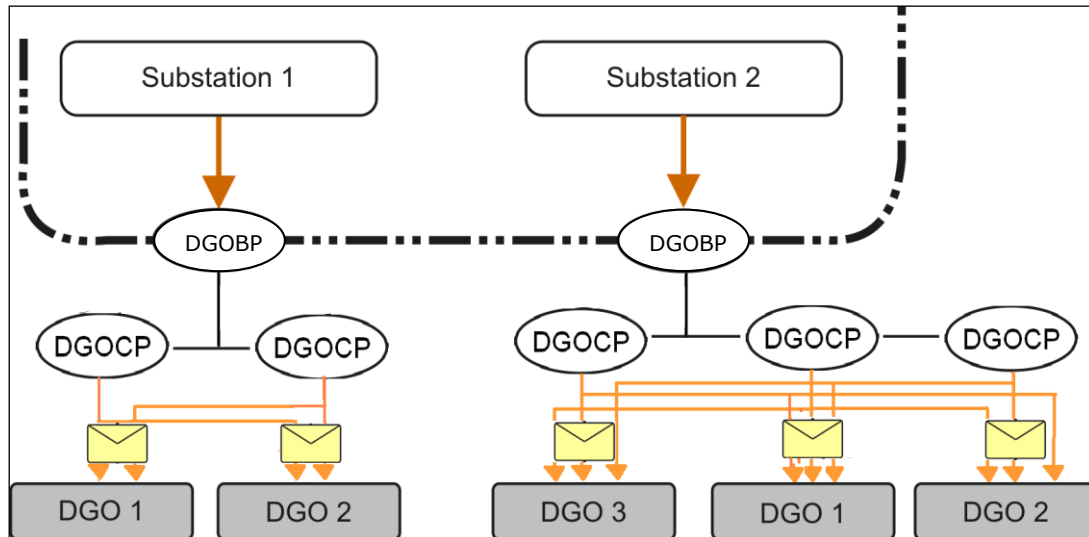

Figure 11 Infeed TSO per substation and per supply bay

The title of the message refers to “infeed”, implying a flow from Elia to the DGO, but in fact the power can flow in either direction. The direction is indicated in the ‘data’ section of the message.

All of the parameters used to describe power values are explained in section 1.1. Full details on all the descriptive fields and the possible values they can take can be found in section 2.7 (for the CSV format messages), section 4.6 (for the XML format messages) and section 4.6 (for the XLSX format messages).

### 2.7.1. Recipients

The recipients and delivery frequency of this message is summarized at section “1.2.8 Regulated messages & message delivery frequency ” page 19.

### 2.7.2. Accessing Infeed TSO per substation and per supply bay messages

Infeed TSO per substation and per supply bay messages are “regulated” messages and delivered on a daily or a monthly basis. The delivery schedule for regulated messages is described in section 1.2.4 on page 17.

More information on accessing messages is given in Chapter 6.

### 2.7.3. Message content

The “Infeed TSO per substation and per supply bay” message contains the data for one calendar month.

The structure of the message identifies the client, the substation supply bay, the time period, all the parameters used to describe the power values and the actual power values. This message content can be delivered in one of three formats; CSV described in section 2.7.3.1 below, XML format described in section 2.7.3.2 and XLSX format described in section 2.7.3.3.

### 2.7.3.1. CSV Infeed TSO per substation and per supply bay

Infeed TSO per substation and per supply bay messages contain a <header> row, a <data> row and <schedule> sections. An example of a daily CSV message for 1 distribution point for Active power, Net, Non-Compensated is shown below.

```

<header>;5499770302608;549912345678;2004-06-10T08:18:34+02:00
<data>;5499770302608;CONS;541453110145211219

<schedule>;2005-06-06T22:00:00Z;1440;15;A;N;NC;ULP;W;False; 0;N; 0;N;
69815.283;N; 69822.276;N; 70414.745;N; 72648.07;N; 70612.372;N; 70813.118;N;
70353.604;N; 70919.58;N; 70980.202;N; 70585.069;N; 70750.728;N; 70958.432;N;
70776.714;N; 70545.643;N; 71100.622;N; 72332.169;N; 71764.899;N; 70709.063;N;
70696.182;N; 70826.037;N; 70635.557;N; 70591.541;N; 70474.789;N; 70828.492;N;
70621.441;N; 70479.102;N; 70633.711;N; 71908.358;N; 71956.669;N; 70695.815;N;
70613.909;N; 70737.232;N; 71454.805;N; 69888.043;N; 70074.782;N; 69324.786;N;
70842.82;N; 71021.133;N; 70678.198;N; 70627.358;N; 71339.325;N; 71856.235;N;
70556.298;N; 70934.224;N; 71104.177;N; 71003.121;N; 70745.411;S; 71149.1;N;
70714.625;N; 70555.06;N; 70575.312;N; 71773.064;N; 72108.967;N; 70849.043;N;
70963.407;N; 70666.142;N; 70749.688;N; 70776.87;N; 70678.946;N; 71291.748;N;
70793.857;N; 70887.839;N; 70681.146;N; 70760.146;N; 70729.713;N; 70804.071;N;
70291.859;N; 69827.026;N; 70384.598;N; 70666.833;N; 70785.496;N; 70202.614;N;
70528.963;N; 71262.107;N; 70829.412;N; 70860.176;N; 70963.875;N; 71144.164;N;
71032.454;N; 70957.065;N; 70815.127;N; 71160.487;N; 71253.751;N; 69908.861;N;
65921.615;N; 64128.27;N; 63491.778;N; 63507.779;N; 64952.333;N; 63870.739;N;
62801.054;N; 63109.382;N; 63421.165;N; 65832.926;N
<end>
    
```

Example 27 CSV Infeed TSO per substation and per supply bay message

#### 2.7.3.1.1. <header>

The <header> row contains information about the sender, the receiver and the time of creation of the message. There is only one <header> row in the message. For a complete description of all the <header> fields see section 3.7 on page 115.

```
<header>;5499770302608;549912345678;2004-06-10T08:18:34+02:00
```

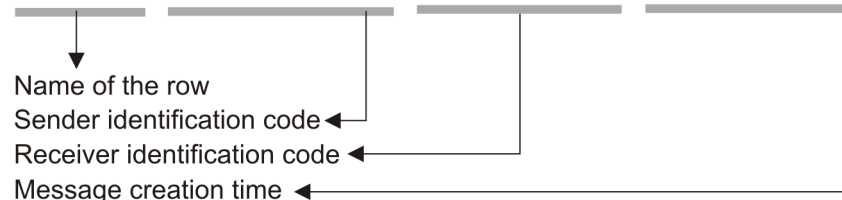

#### 2.7.3.1.2. <data>

A <data> row contains information about all the metering values that are contained in the associated <schedule> section. A <data> section is always followed by at least one <schedule> section. The <data> section identifies the source of the metering data, the direction of flow of the power, the DGO Connection Point/Supply bay within the substation. For a complete description of all the <data> fields see section 3.7 on page 115.

```
<data>;5499770302608;CONS;541453110145211219
```

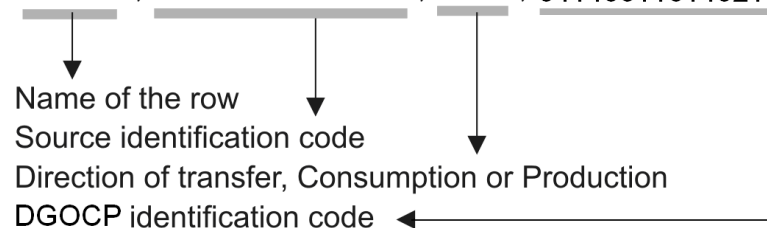

#### 2.7.3.1.3. <schedule>

A <schedule> section contains the actual power values transferred over the specified time period and identifies the type of power. For one supply bay (identified in the <data> section) there can be a number of <schedules>, those distinguishing the separate transfer of Active and Inductive power

for example. The fields contained in the <schedule> are listed below; the general meaning of these fields can be found in section 1.1 and details of all their possible values can be found in section 3.7.1.3 on page 116.

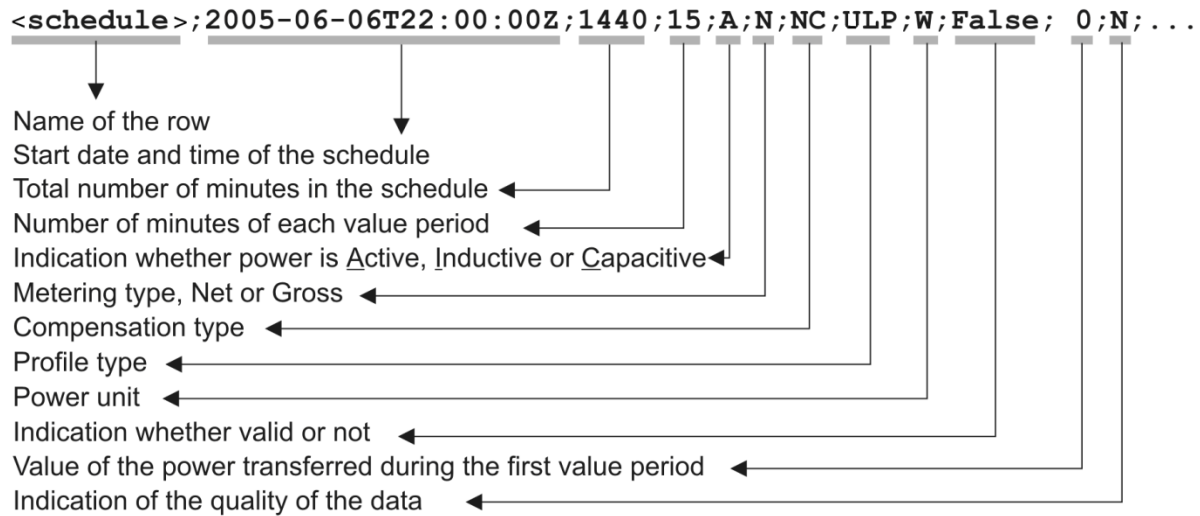

### 2.7.3.2. XML Infeed TSO per substation and per supply bay

The XML Infeed TSO per substation and per supply bay message is a file with a <BorderPointSupplyBayValues> root element. The root element contains a <header> element and a <data list> element.

```
<?xml version="1.0" encoding="iso-8859-1"?>
<BorderPointSupplyBayValues
xmlns="http://www.elia.be/namespaces/public/evms/b2bmsg">
+ <header>
+ <data-list >
</BorderPointSupplyBayValues >
```

*Example 28 XML Infeed TSO per substation and per supply bay message root*

The single <header> element contains information about the sender of the message (Elia), the receiver as well as the time when the message was created.

```
<header>
+ <sender> (contains fields identifying the sender)
+ <receiver> (contains fields identifying the receiver)
<timestamp>2004-02-05T09:31:10Z</timestamp>
</header>
```

*Example 29 XML Infeed TSO per substation and per supply bay message <header>*

The <data-list> can contain one or more <data> element.

```
<data-list>
+ <data>
</data-list>
```

*Example 30 XML Infeed TSO per substation and per supply bay message <data-list>*

The <data> element contains information about the flow of the energy (from and to the parties involved). It identifies the supply bay (<DPEanCode>) and a <schedule-list> that lists the actual power values.

```
<data-list>
<data>
+ <partyFrom>
+ <partyTo>
+ <schedule-list>
  <DPEanCode>1234567899876</DCPEanCode>
</data>
</data-list>
```

*Example 31 XML Infeed TSO per substation and per supply bay message <data>*

The general meaning of these fields can be found in section 1.1. A full description of all the fields and the values they can take is given in section 4.6 on page 143.

**2.7.3.3. Excel Infeed TSO per substation and per supply bay**

The Excel file contains one sheet named from the supply bay EAN code: This sheet contains all information about the supply bay values for the given month:

The top rows contain information about the receiver, the supply bay code and name and the time of creation (last update) of the message.

Subsequent area of the sheet is divided into columns

The first lines of the columns give information about the metering data (direction of the flow, power type, metering type, compensation type)

The quarter hourly values give the power value and the quality for the mentioned metering data

	A	B	C	D	E	F	G	H	I	J	K	L	M	N	O
1	Company														
2	Meterable	541453113496035336													
3	Last Update	23.04.2014													
4	Validation Status	Non validated by Elia													
5															
6	Meterable type			Outgoing Active Net		Outgoing Capacitive Net		Outgoing Inductive Net		Incoming Active Net		Incoming Capacitive Net		Incoming Inductive Net	
7				Non Compensated	Quality	Non Compensated	Quality	Non Compensated	Quality	Non Compensated	Quality	Non Compensated	Quality	Non Compensated	Quality
8															
9	Monthly energy			7,162,931 KWh	Valid	132,404 KVARh	Valid	333,618 KVARh	Valid	0 KWh	Valid	0 KVARh	Valid	0 KVARh	Valid
10															
11	Quarter hourly values														
12	Date	From	To	W	VAR	VAR	VAR	W	VAR	VAR	VAR	VAR	VAR	VAR	VAR
13															
14	01-01-2014	00:00	00:15	8,004,865	N	644,631	N	0	N	0	N	0	N	0	N
15	01-01-2014	00:15	00:30	7,809,618	N	505,344	N	56,204	N	0	N	0	N	0	N
16	01-01-2014	00:30	00:45	7,652,248	N	0	N	179,119	N	0	N	0	N	0	N
17	01-01-2014	00:45	01:00	7,496,054	N	270,511	N	132,934	N	0	N	0	N	0	N
18	01-01-2014	01:00	01:15	7,293,033	N	755,572	N	0	N	0	N	0	N	0	N
19	01-01-2014	01:15	01:30	7,098,764	N	860,160	N	0	N	0	N	0	N	0	N
20	01-01-2014	01:30	01:45	7,011,771	N	846,964	N	0	N	0	N	0	N	0	N
21	01-01-2014	01:45	02:00	6,914,270	N	828,637	N	0	N	0	N	0	N	0	N
22	01-01-2014	02:00	02:15	6,877,859	N	771,456	N	0	N	0	N	0	N	0	N
23	01-01-2014	02:15	02:30	6,731,730	N	834,256	N	0	N	0	N	0	N	0	N
24	01-01-2014	02:30	02:45	6,562,875	N	871,645	N	0	N	0	N	0	N	0	N
25	01-01-2014	02:45	03:00	6,448,024	N	520,250	N	10,752	N	0	N	0	N	0	N
26	01-01-2014	03:00	03:15	6,490,054	N	977	N	92,614	N	0	N	0	N	0	N
27	01-01-2014	03:15	03:30	6,384,489	N	244	N	50,828	N	0	N	0	N	0	N
28	01-01-2014	03:30	03:45	6,265,973	N	2,932	N	28,346	N	0	N	0	N	0	N
29	01-01-2014	03:45	04:00	6,099,806	N	43,985	N	2,444	N	0	N	0	N	0	N
30	01-01-2014	04:00	04:15	6,178,979	N	2,688	N	27,857	N	0	N	0	N	0	N
31	01-01-2014	04:15	04:30	6,060,219	N	76,975	N	489	N	0	N	0	N	0	N
32	01-01-2014	04:30	04:45	5,945,123	N	985,274	N	0	N	0	N	0	N	0	N
33	01-01-2014	04:45	05:00	5,826,118	N	1,059,316	N	0	N	0	N	0	N	0	N
34	01-01-2014	05:00	05:15	5,549,522	N	986,007	N	0	N	0	N	0	N	0	N

Example 32 Excel (XLSX) Infeed TSO per substation and per supply bay message

## 2.8. GEMP

The Global Elia Metered Position (GEMP) message provides aggregated data to the Balance Responsible Parties (BRP). The data is summed in three ways:

- Nationally over all Belgium.

Each of the power values contained is the total sum of the active energy for all Access Points of the BRP.

- Regionally over each regulated region in Belgium.

Each of the power values contained is the sum of the active energy for all Access Points of the BRP in a particular region.

- Regionally for each region and each Supplier.

Each of the power values contained is the sum of the active energy for all Access Points of the BRP in a particular region that are fed by a particular Supplier.

All the data is delivered in one message, with separate data sections for the different summations.

The regions supported are:

- Flanders (FLE)
- Wallonia (WAL)
- Brussels (BRU)
- Federal (FED)

A schematic representation of an arrangement of BRPs, Suppliers and regions to illustrate this is shown in the Figure below:

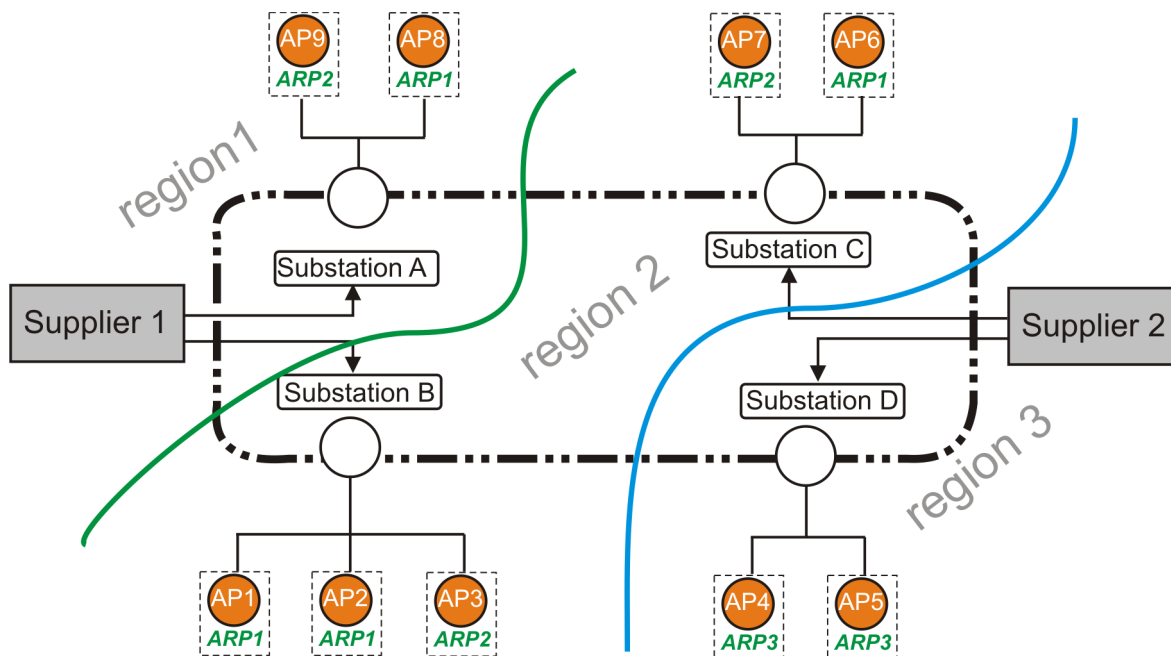

Figure 12 GEMP messages<sup>2</sup>

<sup>2</sup> ARP is the former denomination for BRP





```
,N;480;N;660;N;580;N;580;N;520;N;500;N;520;N;480;N;500;N;580;N;640;N;660;N;640;N;640;N;680;N;660;N;680;N;660;N;660;N;680;N;620;N;620;N;640;N;620;N;680;N;740;N;760;N;740;N;780;N;780;N;760;N;660;N;640;N;600;N;580;N;540;N;460;N;400;N;380;N;380;N;340;N;340;N;340;N;320;N;380;N;340;N;320;N;300;N;260;N;240;N
[end]
```

Example 33 CSV Global Elia Metered Position (GEMP) message

**2.8.3.1.1. [header]**

The header of the message defines the sender and receiver of the message as well as the time of its creation. There is only one [header] row in the message.

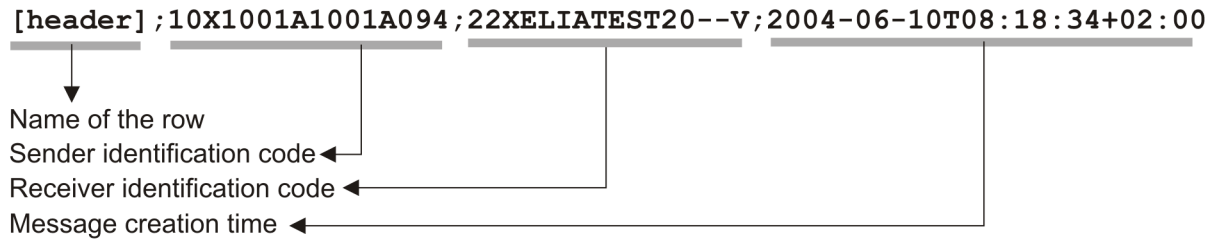

**2.8.3.1.2. [data(x)]**

There are three data sections in the message that correspond to the three summations, [dataG], [dataR] and [dataS].

[dataG] – contains the national summation for all Access Points in Belgium. Each [dataG] section identifies the source of the metering data and the direction of the power flow.

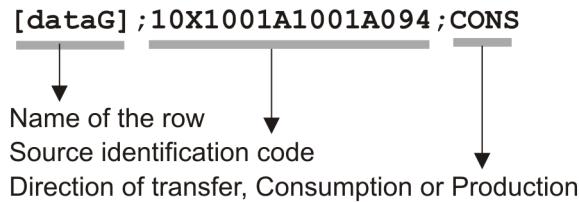

[dataR] – contains the regional summation. Each [dataR] section identifies the source of the metering data, the direction of the power flow and the region.

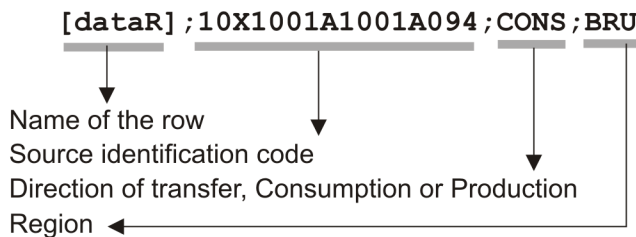

[dataS] – contains the summation per region and per supplier. Each [dataS] section identifies the source of the metering data, the direction of the power flow, the region and the energy supplier.

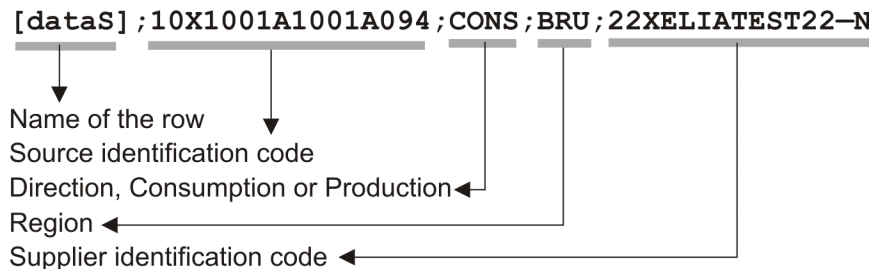

**2.8.3.1.3. [schedule]**

The [schedule] section contains the actual metered values for the corresponding [data] section. Each [schedule] section identifies all the parameters used to describe the power as well as the actual power values.

**[schedule] ; 2005-03-07T23:00:00Z; 1440; 15; I; N; NC; ULP; VAR; False; 16417.082; N; . .**

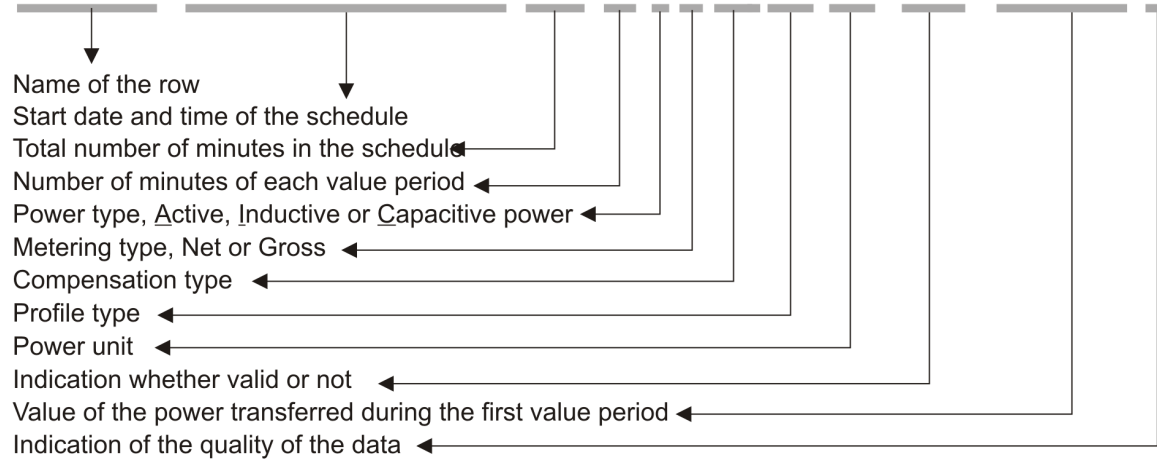

Each of these parameters is described in section 1.1. The specific values that they can take are described in section 3.8.1.

### 2.8.3.2. XML GEMP

The summed metered data is supplied in a single message (contained in the <ARPAAllGemp> root element) which contains 3 sub sections:

- <ARPGemp> contains the national summed data.
- <ARPRRegionGemp> contains the data summed per region.
- <ARPSupplierGemp> contains the data summed per region and per supplier.

```

<?xml version="1.0" encoding="iso-8859-1"?>
<ARPAAllGemp xmlns="http://www.elia.be/namespaces/public/evms/b2bmsg">
+ <ARPGemp>
+ <ARPRRegionGemp>
+ <ARPSupplierGemp>
</ARPAAllGemp>
  
```

*Example 34 XML ARPAAllGemp message root*

Each of the subsections follows the same pattern, as in the example shown below. They each contain a <header> element and a <data-list> element.

```

<ARPGemp>
+ <header>
+ <data-list>
</ARPGemp>
  
```

*Example 35 XML GEMP message <ARPGemp>*

The single <header> element contains information about the sender of the message (Elia), the receiver, the time when the message was created and the type of message.

```

<header>
+ <sender> (contains fields identifying the sender)
+ <receiver> (contains fields identifying the receiver)
  <timestamp>2004-02-05T09:31:10Z</timestamp>
  <MsgGempType> (contains the type of message)
</header>
  
```

*Example 36 XML GEMP message <header>*

The <data-list> can contain one or more <data> sections.

```

  <data-list>
  <data>
  
```

```

+ <partyFrom>
+ <partyTo>
+ <schedule-list>
</data>
</data-list>
    
```

**Example 37 XML GEMP message <data-list>**

The <data> element contains information about the flow of the power (from and to the parties involved) and a <schedule-list> that lists the actual power values.

All the concepts related to these parameters are described in section 1.1. A full description of all the fields and the values they can take is given in section 4.7.

**2.8.3.3. Excel GEMP**

The Excel file contains one sheet named "000000000000000000": This sheet contains all information about the GEMP values for the given month:

The top rows contain information about the receiver, the "000000000000000000" code and "GEMP" and the time of creation (last update) of the message.

Subsequent area of the sheet is divided into columns

The first lines of the columns contains information about the metering data (direction of the flow, power type, metering type, compensation type)

The quarter hourly values give the power value and the quality for the mentioned metering data

Company		Meterable		Last Update		Validation Stat		GEMP														
Meterable type		Total		Total		Total		Total		Total		Total		Brn		Brn						
		Outgoing Active Gross		Outgoing Active Net		Outgoing Active Net		Incoming Active Gross		Incoming Active Net		Incoming Active Net		Outgoing Active Gross		Outgoing Active Net						
Monthly energy		Compensated 0 KWh		Quality Invalid		Compensated 0 KWh		Quality Invalid		Non Compensated 0 KWh		Quality Invalid		Compensated 0 KWh		Quality Invalid		Non Compensated 0 KWh		Quality Invalid		
Quarter hourly values		Date		From		To		V		V		V		V		V		V		V		
01-01-2015	00:00	00:15	0	1	0	1	0	1	0	1	0	1	0	1	0	1	0	1	0	1	0	1
01-01-2015	00:15	00:30	0	1	0	1	0	1	0	1	0	1	0	1	0	1	0	1	0	1	0	1
01-01-2015	00:30	00:45	0	1	0	1	0	1	0	1	0	1	0	1	0	1	0	1	0	1	0	1
01-01-2015	00:45	01:00	0	1	0	1	0	1	0	1	0	1	0	1	0	1	0	1	0	1	0	1
01-01-2015	01:00	01:15	0	1	0	1	0	1	0	1	0	1	0	1	0	1	0	1	0	1	0	1
01-01-2015	01:15	01:30	0	1	0	1	0	1	0	1	0	1	0	1	0	1	0	1	0	1	0	1
01-01-2015	01:30	01:45	0	1	0	1	0	1	0	1	0	1	0	1	0	1	0	1	0	1	0	1
01-01-2015	01:45	02:00	0	1	0	1	0	1	0	1	0	1	0	1	0	1	0	1	0	1	0	1
01-01-2015	02:00	02:15	0	1	0	1	0	1	0	1	0	1	0	1	0	1	0	1	0	1	0	1
01-01-2015	02:15	02:30	0	1	0	1	0	1	0	1	0	1	0	1	0	1	0	1	0	1	0	1
01-01-2015	02:30	02:45	0	1	0	1	0	1	0	1	0	1	0	1	0	1	0	1	0	1	0	1
01-01-2015	02:45	03:00	0	1	0	1	0	1	0	1	0	1	0	1	0	1	0	1	0	1	0	1
01-01-2015	03:00	03:15	0	1	0	1	0	1	0	1	0	1	0	1	0	1	0	1	0	1	0	1
01-01-2015	03:15	03:30	0	1	0	1	0	1	0	1	0	1	0	1	0	1	0	1	0	1	0	1
01-01-2015	03:30	03:45	0	1	0	1	0	1	0	1	0	1	0	1	0	1	0	1	0	1	0	1
01-01-2015	03:45	04:00	0	1	0	1	0	1	0	1	0	1	0	1	0	1	0	1	0	1	0	1
01-01-2015	04:00	04:15	0	1	0	1	0	1	0	1	0	1	0	1	0	1	0	1	0	1	0	1
01-01-2015	04:15	04:30	0	1	0	1	0	1	0	1	0	1	0	1	0	1	0	1	0	1	0	1
01-01-2015	04:30	04:45	0	1	0	1	0	1	0	1	0	1	0	1	0	1	0	1	0	1	0	1
01-01-2015	04:45	05:00	0	1	0	1	0	1	0	1	0	1	0	1	0	1	0	1	0	1	0	1
01-01-2015	05:00	05:15	0	1	0	1	0	1	0	1	0	1	0	1	0	1	0	1	0	1	0	1
01-01-2015	05:15	05:30	0	1	0	1	0	1	0	1	0	1	0	1	0	1	0	1	0	1	0	1
01-01-2015	05:30	05:45	0	1	0	1	0	1	0	1	0	1	0	1	0	1	0	1	0	1	0	1
01-01-2015	05:45	06:00	0	1	0	1	0	1	0	1	0	1	0	1	0	1	0	1	0	1	0	1
01-01-2015	06:00	06:15	0	1	0	1	0	1	0	1	0	1	0	1	0	1	0	1	0	1	0	1
01-01-2015	06:15	06:30	0	1	0	1	0	1	0	1	0	1	0	1	0	1	0	1	0	1	0	1
01-01-2015	06:30	06:45	0	1	0	1	0	1	0	1	0	1	0	1	0	1	0	1	0	1	0	1

Example 38 Excel (XLSX) Global Elia Metered Position (GEMP) message

## 2.9. Imbalance

Electricity cannot be stored in large quantities at a reasonable price.

Therefore, one of the objectives of Elia, as Transport System Operator (TSO), is to maintain the Elia electrical grid "in balance": practically, on the Elia grid, the production (injection) of electricity must be continually adjusted with the consumption (offtake) of electricity.

In more general terms, the energy coming on the Elia grid must always be equal with the energy leaving the Elia grid. The energy can be produced or consumed in Belgium but also imported from or exported to other European countries.

The BRP "injects" ("IN") and "offtakes" ("OUT") electricity on the Elia grid. The sum of these "IN" and "OUT" constitutes the "balance perimeter" of the BRP.

In order to be sure that BRP respects the golden rule on his balance perimeter, Elia calculates the Imbalance settlement for each quarter: Per quarter hour, this is the difference between:

- IN: the quantity of energy coming in the balance perimeter of the BRP and
- OUT: the energy going out the balance perimeter of the BRP.

E.g. Injection on the left side is in balance with offtake on the right side:

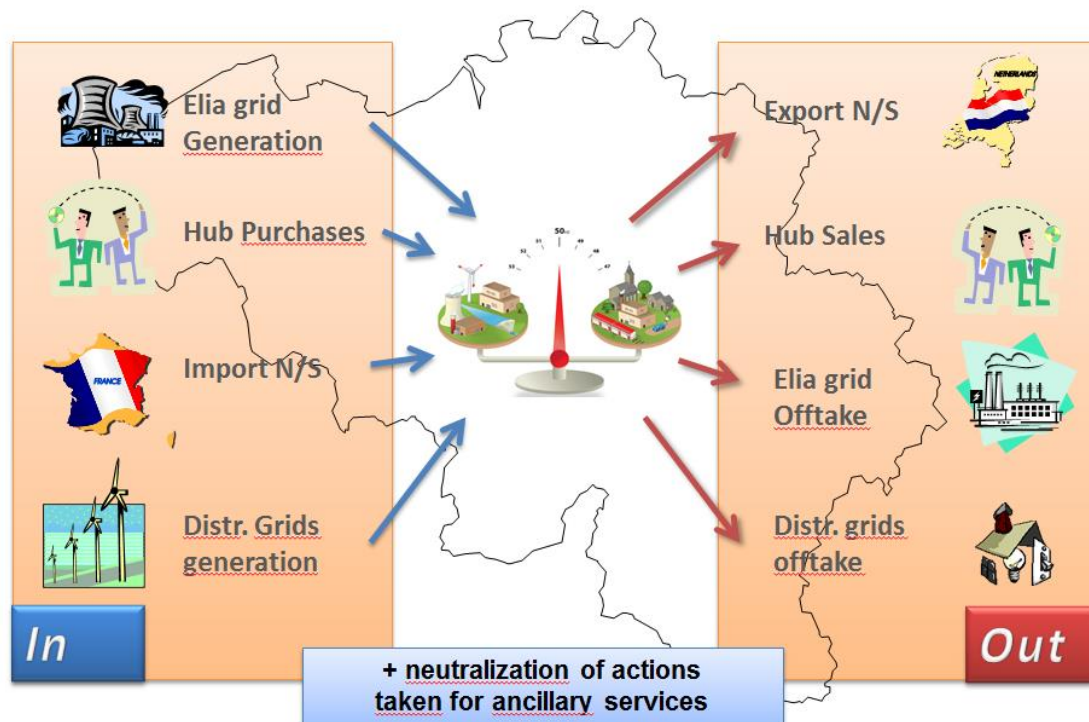

Figure 13: Balance perimeter

**IN** = The total injection of the BRP equals the sum of many components, for that quarter hour:

- all imports (for this BRP) from other European grid
- all injections at the injection Points allocated to the BRP
- all distribution injection positions allocated to the BRP
- all injections by internal transfers of nominated by the BRP ("as the buyer")

**OUT** = The Total offtake of the BRP equals the sum of many components, for that quarter hour:

- all exports (for this BRP) to other European grid
- all offtakes at the offtake points allocated to the BRP
- all distribution offtake positions allocated to the BRP
- all offtakes by internal transfers of energy nominated by the BRP ("as the seller")

At the difference of "classical" messages explained before in this document, the Imbalance message contains components. A component within a message represents a Business flow. The energy is measured per quarter hour. For each quarter hour, the "balance perimeter" of the BRP may contain many components.

Each component is supposed well known by the recipient and is published in order to facilitate the analysis in case of error: its detailed business meaning is not described in this document.

The list of possible components is given in "2.9.3.1 Imbalance components".

Full details on all the descriptive fields and the possible values they can take can be found in section 3.9 (for the CSV format messages), section 4.8 (for the XML format messages) and section 5.7 (for the XLSX format messages).

### **2.9.1. Recipients**

Imbalance value messages are regulated messages received by the Balance Responsible Parties (BRP) who receive the components for which they are responsible or which impact their perimeter. This message is delivered as annex to the invoice of the BRP.

### **2.9.2. Accessing Imbalance messages**

Imbalance messages are not published regularly. They are delivered to the BRP when Elia has collected and validated all the data of the BRP balance perimeter for one given month, before the imbalance invoicing (at latest by the end of the second month after the given month).

More information on accessing messages is given in section "Accessing messages".

### **2.9.3. Message content**

Imbalance messages identify the client, the time period, all the parameters of each component used to describe the power values. This message content can be delivered in one of three formats: CSV described in section 2.9.3.1 below, XML format described in section "2.9.3.7 and Excel (XLSX) format described in section 2.9.3.8 Excel Imbalance Value.

#### **2.9.3.1. Imbalance components**

The business concepts behind each component are explained in the contractual document given to the BRP. This manual gives only a short description.

The imbalance components that can be counted to the BRP are:

Component	Description
CrossBorderExportTotal	Total cross border export position of the BRP: Total energy going out the BRP balance perimeter on the Elia grid
CrossBorderImportTotal	Total cross border import position of the BRP: Total energy coming in the BRP balance perimeter on the Elia grid
HubSalesTotal	Total of the sales of the BRP on Elia Hub (included its sales on the Power Exchanges)
HubPurchasesTotal	Total of the purchase (buy) of the BRP on Elia Hub (included its purchases on the Power Exchanges)
aFRRUpCorrTotal	Compensation for activation of aFRR upward (positive).
aFRRDownCorrTotal	Compensation for activation aFRR downward (negative).
mFRRCipuAndCipuUpCorrTotal	Compensations for activation of mFRR CIPU (DP <sub>SU</sub> ) & CIPU congestion/free incremental bids. This component is replacing the "R3AndCipuUpCorrTotal" component.
mFRRCipuAndCipuDownCorrTotal	Compensations for activation of mFRR CIPU (DP <sub>SU</sub> ) bids and CIPU (congestion/free) decremental bids. This component is replacing the "R3AndCipuUpCorrTotal" component.
mFRRDPpg&DA/IDBrpSourceCorrTotal	Compensations of the BRP <sub>SOURCE</sub> of a Delivery Point performed in the context of mFRR and/or DA/ID activations (Upward & Downward) of delivery points DP <sub>PG</sub> . The compensation's amount corresponds to the energy delivered by the activated DP <sub>PG</sub> falling under a ToE regime (= -Edel).
mFRRDPpg&DA/IDBrpBspCorrTotal	Compensations of the BRP <sub>BSP/FSP</sub> performed in the context of mFRR and/or DA/ID activations (Upward & Downward) of delivery points DP <sub>PG</sub> . This component corresponds to the mFRRDPpg&DA/IDDownBrpBspCorr component minus the mFRRDPpg&DA/IDUpBrpBspCorr component.
mFRRDPpg&DA/IDUpBrpBspCorr	Compensations of the BRP <sub>BSP/FSP</sub> performed in the context of mFRR and/or DA/ID upward activations of delivery points DP <sub>PG</sub> . The compensation's amount corresponds to : <ul style="list-style-type: none"> <li>For mFRR activations: the difference between the upward energy requested by Elia and the energy delivered in the upward direction by the activated DP<sub>PG</sub> falling under a ToE regime.(=- (Ereq-Edel)</li> <li>For DA/ID activations: the energy delivered in the upward direction by the activated DP<sub>PG</sub> falling under a ToE regime (=Edel).</li> </ul>
mFRRDPpg&DA/IDDownBrpBspCorr	Compensations of the BRP <sub>BSP/FSP</sub> performed in the context of mFRR and/or DA/ID downward activations of delivery points DP <sub>PG</sub> . The compensation's amount corresponds to : <ul style="list-style-type: none"> <li>For mFRR activations: the difference between the downward energy requested by Elia and the energy delivered in the downward direction by the activated DP<sub>PG</sub> falling under a ToE regime. (- (Ereq-Edel)</li> <li>For DA/ID activations: the energy delivered in the downward direction by the activated DP<sub>PG</sub> falling under a ToE regime (=Edel)..</li> </ul>

mFRRDPpg&DA/IDTotal	Sum of the compensations (BRP <sub>Source</sub> & BRP <sub>BSP/FSP</sub> ) performed in the context of mFRR and/or DA/ID activations (Upward & Downward) of delivery points DP <sub>PG</sub> . This component corresponds to the sum of the mFRRDPpg&DA/IDBrpSourceCorrTotal & mFRRDPpg&DA/IDBrpBspCorrTotal components.
OtherUpCorrTotal	Additional Upward balancing compensation: This component represents additional upward compensation in case of specific agreement.
OtherDownCorrTotal	Additional Downward balancing compensation: This component represents additional downward compensation in case of specific agreement.
DGOInjectionTotal	Total of injection of the BRP for all DGO Network
DGOOfftakeTotal	Total of offtake of the BRP for all DGO Network
DGOLossesTotal	Total of losses of the BRP related to its clients on DGO Networks
DGOInjection	Allocation injection of the BRP for one DGO Network
DGOOfftake	Allocation offtake of the BRP for one DGO Network
DGOLoopLossesTotal	Total of Loop losses (Clearing difference) for the DGO Network attributed to the BRP
DGOLoopLosses	Loop losses (Clearing difference) of a DGO Network
CDSInjectionTotal	Total of injection of the BRP for all CDS Network
CDSOfftakeTotal	Total of offtake of the BRP for all CDS Network
CDSLosesTotal	Total of losses of the BRP related to its clients on CDS Networks
CDSInjection	Allocation injection of the BRP for one CDS Network
CDSOfftake	Allocation offtake of the BRP for one CDS Network
CDSLoopLossesTotal	Total of Loop losses Clearing Difference for the CDS network attributed to the BRP
CDSLoopLosses	Loop losses (Clearing difference) of a CDS Network
TSOOfftakeTotal	Total offtake of the BRP for its clients on the TSO network
TSOInjectionTotal	Total injection of the BRP from its clients on the TSO network
TSOLosesTotal	Total losses of the BRP related to its clients on the TSO network
ImbalanceResultofthePooling	The imbalance of the pooling. (The Imbalance counted to the BRP "head of Pool". Is the sum of individual imbalance of the member of the pool in case of pooling agreement)
OffshoreInterconnectionOfftakeTotal	Total offtake of the BRP <sub>O.I.</sub> associated with this Offshore Interconnection
OffshoreInterconnectionInjectionTotal	Total injection of the BRP <sub>O.I.</sub> associated with this Offshore Interconnection
ImbalanceRecipient	Total Imbalance of the BRP



Old Component	Description
R1CorrTotal	Primary Reserve: Compensation for activation of R1 (Delta F negative = upward; Delta F positive = downward). This component is deprecated/not published anymore.
R2UpCorrTotal	Secondary Reserve: Compensation for activation R2 upward (positive). This component is deprecated/not published anymore.
R2DownCorrTotal	Secondary Reserve: Compensation for activation R2 downward (negative). This component is deprecated/not published anymore.
R3AndCipuUpCorrTotal	Tertiary Reserve: Compensation for activation of R3 & CIPU incremental bids (Upward or positive). This component is deprecated/not published anymore.
R3AndCipuDownCorrTotal	Tertiary Reserve: Compensation for activation of R3 & CIPU decremental bids (Downward or negative). This component is deprecated/not published anymore.
R3EUpbyBSP	Tertiary Control Non Reserved Power Service by Non-CIPU Technical Unit: Compensation for activation of R3E incremental bids (Upward or positive). This component is deprecated/not published anymore.
R3EDownbyBSP	Tertiary Control Non Reserved Power Service by Non-CIPU Technical Unit: Compensation for activation of R3E decremental bids (Downward or negative). This component is deprecated/not published anymore.
R3ETotal	Tertiary Control Non Reserved Power Service by Non-CIPU Technical Unit: Compensation for activation of R3E bids. This component is deprecated/not published anymore.
DchCompensationTotal	Total of the DCH Compensation for the Offshore Wind Parks attributed to the BRP. This component is deprecated/not published anymore.
mFRRnonCipuBrpSourceCorrTotal	Compensations of the BRP <sub>SOURCE</sub> of a Delivery Point performed in the context of an mFRR non CIPU units (DP <sub>PG</sub> ) activation (Upward & Downward). The compensation's amount corresponds to the energy delivered by the activated DP <sub>PG</sub> falling under a ToE regime.
mFRRnonCipuBrpBspCorrTotal	Compensations of the BRP <sub>BSP</sub> performed in the context of an mFRR non CIPU units (DP <sub>PG</sub> ) activation (Upward & Downward). This component corresponds to the mFRRnonCipuBrpBspDownCorr component minus the mFRRnonCipuBrpBspUpCorr component.
mFRRnonCipuBrpBspUpCorr	Compensations of the BRP <sub>BSP</sub> performed in the context of mFRR non CIPU units (DP <sub>PG</sub> ) upward activations. The compensation's amount corresponds to the difference between the upward energy requested by Elia and the energy delivered by the activated DP <sub>PG</sub> falling under a ToE regime.
mFRRnonCipuBrpBspDownCorr	Compensations of the BRP <sub>BSP</sub> performed in the context of mFRR non CIPU units (DP <sub>PG</sub> ) downward activations. The compensation's amount corresponds to the difference between the downward energy requested by Elia and the energy delivered by the activated DP <sub>PG</sub> falling under a ToE regime.



mFRRnonCipuTotal	Sum of the compensations (BRP Source & BRP BSP) performed in the context of mFRR non CIPU units (DP PG) activations (Upward & Downward). This component corresponds to the sum of the mFRRnonCipuBrpSourceCorrTotal & mFRRnonCipuBrpBspCorrTotal components.
------------------	--

**Remarks:**

This list can always vary when new components of the Imbalance could be created based on new market rules.

Elia does not guarantee the order of components within the message.

**2.9.3.2. Imbalance components criteria's**

In the following list the columns must be understood as:

**Component:** See "2.9.3.1 Imbalance components"

**Flow direction:** the flow of electricity within the BRP Balance perimeter:

- **IN** : the quantity of energy coming in the balance perimeter of the BRP
- **OUT**: the energy going out the balance perimeter of the BRP.

**Possible negative value?** Normally the electricity follows the flow indicated within the column 'Flow direction', but exceptionally electricity can flow in the other direction. In this case, the electricity quarter value is negative

Component	Flow direction	Possible negative values?
CrossBorderExportTotal	Out	No
CrossBorderImportTotal	In	No
HubSalesTotal	Out	No
HubPurchasesTotal	In	No
aFRRUpCorrTotal	Out	No
aFRRDownCorrTotal	In	No
mFRRCipuAndCipuUpCorrTotal	Out	No
mFRRCipuAndCipuDownCorrTotal	In	No
mFRRDPpg&DA/IDBrpSourceCorrTotal	In	Yes
mFRRDPpg&DA/IDBrpBspCorrTotal	In	Yes
mFRRDPpg&DA/IDUpBrpBspCorr	Out	No
mFRRDPpg&DA/IDDownBrpBspCorr	In	No
mFRRDPpg&DA/IDTotal	In	Yes
OtherUpCorrTotal	Out	No
OtherDownCorrTotal	In	No
DGOInjectionTotal	In	No
DGOOfftakeTotal	Out	No
DGOLossesTotal	Out	Yes
DGOInjection	In	No
DGOOfftake	Out	No
DGOLoopLossesTotal	Out	Yes
DGOLoopLosses	Out	Yes
CDSInjectionTotal	In	No
CDSOfftakeTotal	Out	No
CDSLosesTotal	Out	Yes
CDSInjection	In	No
CDSOfftake	Out	No
CDSLoopLossesTotal	Out	Yes
CDSLoopLosses	Out	Yes
TSOOfftakeTotal	Out	No
TSOInjectionTotal	In	No

TSOLossesTotal	Out	No
DchCompensationTotal	Out	Yes
ImbalanceResultofthePooling	In	Yes
OffshoreInterconnectionOfftakeTotal	Out	No
OffshoreInterconnectionInjectionTotal	In	No
ImbalanceRecipient	In	Yes

Old Component	Flow direction	Possible negative values?
R1CorrTotal	In	Yes
R2UpCorrTotal	Out	No
R2DownCorrTotal	In	No
R3AndCipuUpCorrTotal	Out	No
R3AndCipuDownCorrTotal	In	No
R3EUbyBSP	Out	No
R3EDownbyBSP	In	No
R3ETotal	In	Yes
DchCompensationTotal	Out	Yes
mFRRnonCipuBrpSourceCorrTotal	In	Yes
mFRRnonCipuBrpBspCorrTotal	In	Yes
mFRRnonCipuBrpBspUpCorr	Out	No
mFRRnonCipuBrpBspDownCorr	In	No
mFRRnonCipuTotal	In	Yes

### 2.9.3.3. Imbalance components added parameters

In the following list the columns must be understood as:

- **Component** : See section "2.9.3.1 Imbalance components"
- **Party/area**: Each component can be general and referenced to the BRP: this is the "party". For example all border import of the BRP. But some components can be also detailed per "area". For example, a component on a distribution grid has also the grid area code
- **Code**: This code can be:
  - The BRP EIC code
  - The area code
  - A specific EIC code

Component	Party/Area	Code
CrossBorderExportTotal	Party	BRP EIC code
CrossBorderImportTotal	Party	BRP EIC code
HubSalesTotal	Party	BRP EIC code
HubPurchasesTotal	Party	BRP EIC code
aFRRUpCorrTotal	Party	BRP EIC code
aFRRDownCorrTotal	Party	BRP EIC code
mFRRCipuAndCipuUpCorrTotal	Party	BRP EIC code
mFRRCipuAndCipuDownCorrTotal	Party	BRP EIC code
mFRRDPpg&DA/IDBrpSourceCorrTotal	Party	BRP EIC code
mFRRDPpg&DA/IDBrpBspCorrTotal	Party	BRP EIC code
mFRRDPpg&DA/IDUpBrpBspCorr	Party	BSP/FSP EIC code
mFRRDPpg&DA/IDDownBrpBspCorr	Party	BSP/FSP EIC code
mFRRDPpg&DA/IDTotal	Party	BRP EIC code
OtherUpCorrTotal	Party	BRP EIC code
OtherDownCorrTotal	Party	BRP EIC code
DGOInjectionTotal	Area	ALL DGO EIC code: 22YBE-ALLDSO---0
DGOOfftakeTotal	Area	ALL DGO EIC code: 22YBE-ALLDSO---0
DGOLossesTotal	Area	ALL DGO EIC code: 22YBE-ALLDSO---0
DGOInjection	Area	DGO Network EAN code (see "2.9.3.4 Distribution grid area codes ")
DGOOfftake	Area	DGO Network EAN code (see "2.9.3.4 Distribution grid area codes ")
DGOLoopLossesTotal	Area	ALL DGO EIC code:'22YBE-ALLDSO---0
DGOLoopLosses	Area	DGO Network EAN code
CDSInjectionTotal	Area	ALL CDS EIC code: 22YBE-ALLCDS---3
CDSOfftakeTotal	Area	ALL CDS EIC code: 22YBE-ALLCDS---3
CDSLosesTotal	Area	ALL CDS EIC code: 22YBE-ALLCDS---3
CDSInjection	Area	CDS Network EAN code
CDSOfftake	Area	CDS Network EAN code
CDSLoopLossesTotal	Area	ALL CDS EIC code: 22YBE-ALLCDS---3
CDSLoopLosses	Area	CDS Network EAN code
TSOOfftakeTotal	Area	Total on the Elia network: 22YBE-TSO-----9
TSOInjectionTotal	Area	Total on the Elia network: 22YBE-TSO-----9

TSOLossesTotal	Area	Total on the Elia network: 22YBE-TSO-----9
ImbalanceResultofthePooling	Party	BRP EIC code
OffshoreInterconnectionOfftakeTotal	Party	ALL OIP EIC code: 22YBE-ALLOIP---F
OffshoreInterconnectionInjectionTotal	Party	ALL OIP EIC code: 22YBE-ALLOIP---F
ImbalanceRecipient	Party	Can be EIC code of the BRPs member of the pool or BRP EIC code

Old Component	Party/Area	Code
R1CorrTotal	Party	BRP EIC code
R2UpCorrTotal	Party	BRP EIC code
R2DownCorrTotal	Party	BRP EIC code
R3AndCipuUpCorrTotal	Party	BRP EIC code
R3AndCipuDownCorrTotal	Party	BRP EIC code
R3EUbyBSP	Party	BRP EIC code
R3EDownbyBSP	Party	BRP EIC code
R3ETotal	Party	BRP EIC code
DchCompensationTotal	Party	BRP EIC code
mFRRnonCipuBrpSourceCorrTotal	Party	BRP EIC code
mFRRnonCipuBrpBspCorrTotal	Party	BRP EIC code
mFRRnonCipuBrpBspUpCorr	Party	BSP EIC code
mFRRnonCipuBrpBspDownCorr	Party	BSP EIC code
mFRRnonCipuTotal	Party	BRP EIC code

#### 2.9.3.4. Distribution grid area codes

The code used in the metering system refers to its DGO network EAN (these EAN codes are also used in the nomination system).

See [https://www.elia.be/-/media/project/elia/elia-site/customers/metering/installing\\_procedure/installign-procedure/19082019list\\_of\\_distribution\\_grids-v21\\_en.pdf](https://www.elia.be/-/media/project/elia/elia-site/customers/metering/installing_procedure/installign-procedure/19082019list_of_distribution_grids-v21_en.pdf) for the complete list.

Currently following DGO Network are available:

541453179928225270 - AIEG
541453175526064631 - AIESH
541453105692690617 - GASELWEST
541453194559878114 - IMEA
541453174796694517 - IMEWO
541453116958254573 - INTERENERGA
541453126054018733 - INTERGEM

541453182932680843 - IVEG
541453118978518246 - IVEKA
541453117858523134 - IVERLEK
541453152233523132 - ORES (BRABANT WALLON)
541453182435244320 - ORES (EST)
541453122843569516 - ORES (HAINAUT ELECTRICITE)
541453114573305847 - ORES (LUXEMBOURG)
541453137733095884 - ORES (MOUSCRON)
541453170109194514 - ORES (NAMUR)
541453169685000180 - ORES (VERVIERS)
541453175169008979 - PBE
541453131260317563 - SIBELGA
541453175605410335 - SIBELGAS
541453199449664358 - RESA
541453135778772500 - Réseau d'Energies de Wavre
541453199767702817 - Infrac West (WVEM)

Old DGO Network (no more available):

541453178258913758 - TECTEO	01/01/2002 – 30/06/2014
541453118739825484 - TECTEO(IM1)	01/07/2013 – 30/06/2014
541453110776919126 - Régie de l'Electricité de la Ville de Wavre	01/01/2003 – 31/12/2015
541453108472406866 - RESA (IM1)	01/01/2015 – 31/05/2017
541453123314822406 - ORES (PBE Wallonie)	01/01/2018 – 31/08/2018

### 2.9.3.5. Closed Distribution System area codes

The code used in the metering system refers to its CDS network EAN (these EAN codes are also used in the nomination system).

See [https://www.elia.be/-/media/project/elia/elia-site/customers/metering/installing\\_procedure/installign-procedure/list-of-active-closed-distribution-grids-01-01-2018.pdf](https://www.elia.be/-/media/project/elia/elia-site/customers/metering/installing_procedure/installign-procedure/list-of-active-closed-distribution-grids-01-01-2018.pdf) for the complete list.

Currently following CDS Network are available:

541453185522017586 - DNB Brussels Airport _ Zaventem
541453176864035840 - BASF Antwerpen
541453173171146450 - ArcelorMittal Belgium _ Seraing
541453118417028657 - ArcelorMittal Belgium_Ramet

### 2.9.3.6. CSV Imbalance Value

Imbalance messages contain a [header] row, a [data] row describing the component and [schedule] sections. An example of a CSV Imbalance message is shown below:

[header];10X1001A1001A094;22XBRPA-----A;2015-09-14T22:00:00Z;IMBALANCE;10;Final
[data];CrossBorderExportTotal;22XBRPA-----A;OUT
[schedule];2015-07-31T22:00:00Z;1440;15;A;N;C;ALP;KW;695939,469;N;
[end]

Example 39 CSV Imbalance message

The [header] row contains information about the sender and the receiver of the message as well as the time of creation, the version number, state of the message and the fact that this is an Imbalance message. There is only one [header] row in the message. For a complete description of all the [header] fields see section "3.9.1.1 Imbalance [header]".

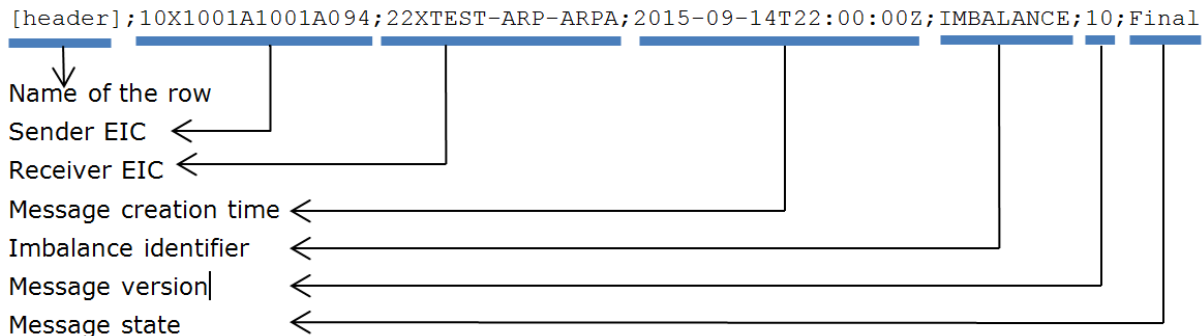

**2.9.3.6.1. [data]**

A [data] row contains information about the component and related criteria's. A [data] section is always followed by at least one [schedule] section. There are several [data] sections that correspond to different components. For a complete description of all the [data] see section "3.9.1.2 Imbalance [data]".

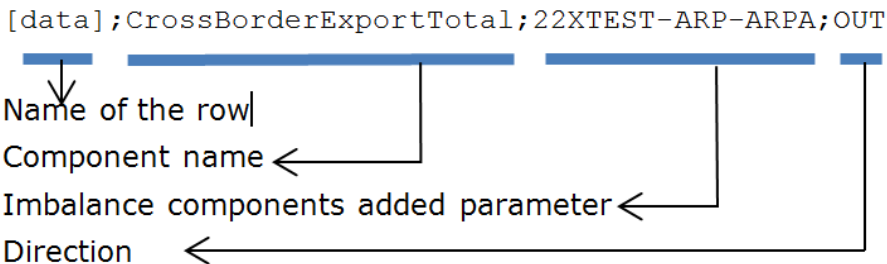

**2.9.3.6.2. [schedule]**

A [schedule] section contains the power values transferred over the specified time period and identifies the type of power. The Time period constitutes 1 day of 23, 24 or 25 hours. For any component identified in the [data] section, there can be a number of [schedules]. The fields contained in the [schedule] are listed below; the general meaning of these fields can be found in section 1.1 and details of all their possible values can be found in section "3.9.1.3 Imbalance [schedule]".

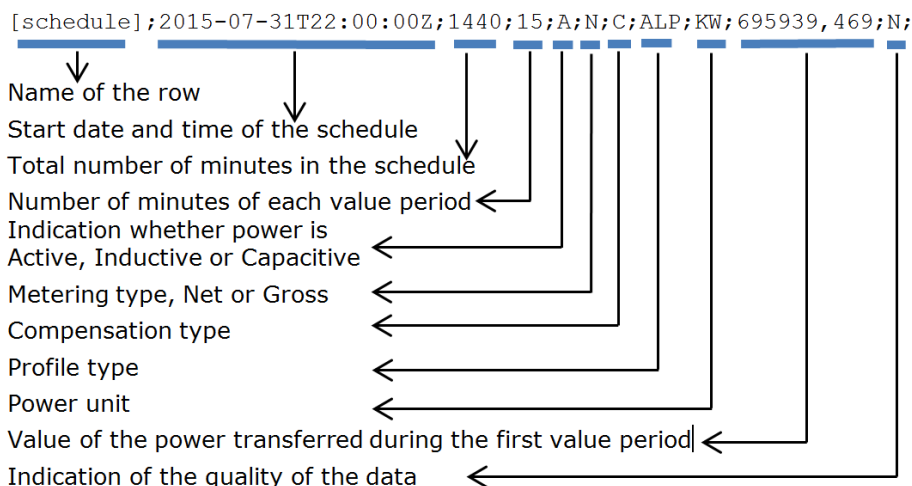

### 2.9.3.7. XML Imbalance

The XML Imbalance message has a structure which is completely different of the other metering messages.

The Elia goal is to replace in a near future all the Metering XML messages in order to cope with European and worldwide standards that are available now: the current Imbalance message respects the **CIM IEC standard 62325-451-4**

The structure therefore is briefly explained in this document but whole description is available on the IEC web store: <https://webstore.iec.ch/publication/29116>

The XSD Schema reference is available on "4.1 Reference XSD".

```
<EnergyAccount_MarketDocument
xsi:schemaLocation="urn:iec62325.351:tc57wg16:451-4:energyaccountdocument:4:0
iec62325-451-4-settlement_v4.xsd" xmlns="urn:iec62325.351:tc57wg16:451-
4:energyaccountdocument:4:0" xmlns:xsi="http://www.w3.org/2001/XMLSchema-
instance">
</EnergyAccount_MarketDocument>
```

#### Example 40 XML Imbalance message root

The message begins with information about the sender of the message (Elia) and the receiver as well as the time when the message was created plus some information about the state of this message: This header is valid for all the Time Series

Technical information on each field is available in "4.8 XML Imbalance messages".

Remark: the XML comments indicated in the message here below are for the reader comprehension and are available in the message sent by Elia.

```
<mRID>IMB_20150801_20150831</mRID><revisionNumber>10</revisionNumber>
<type>A12<!--Imbalance report--></type>
<docStatus><value>A02</value></docStatus><!--Final-->
<process.processType>A06</process.processType> <!--Imbalance settlement-->
<process.classificationType>A01</process.classificationType> <!--Detail-->
<sender_MarketParticipant.mRID
codingScheme="A01">10X1001A1001A094</sender_MarketParticipant.mRID>
<sender_MarketParticipant.marketRole.type>A04</sender_MarketParticipant.marke
tRole.type>
<receiver_MarketParticipant.mRID codingScheme="A01">22XBRPA-----
A</receiver_MarketParticipant.mRID>
<receiver_MarketParticipant.marketRole.type>A08</receiver_MarketParticipant.m
arketRole.type> <!--Balance responsible party-->
<createdDateTime>2015-09-14T22:00:00Z</createdDateTime>
  <period.timeInterval>
    <start>2015-07-31T22:00Z</start>
    <end>2015-08-30T22:00Z</end>
  </period.timeInterval>
<domain.mRID codingScheme="A01">10YBE-----2</domain.mRID>
```

#### Example 41 XML Imbalance message header

The <TimeSeries> element describes the flow of the power for one component and related criteria and the schedule of actual power values.

Technical information on each field is described in section "4.8.2 XML Imbalance TimeSeries fields".

Elia does not guarantee the order of Timeseries within the message.

```
<TimeSeries>
  <mRID>A03-22XBRPA-----A</mRID>
```



```

<businessType>A03</businessType>

<!--OUT=Total export position of the BRP: Total energy going out the
BRP balance perimeter on the Elia grid - IN=Total import position of the BRP:
Total energy coming in the BRP balance perimeter on the Elia grid-->

<product>8716867000016</product>

<objectAggregation>A03</objectAggregation>

<area_Domain.mRID codingScheme="A01">10YBE-----
2</area_Domain.mRID>

<marketParticipant.mRID codingScheme="A01">22XBRPA-----A

</marketParticipant.mRID>

<measure_Unit.name>KWT</measure_Unit.name>

<Period>

</TimeSeries>
    
```

Example 42 XML Imbalance message TimeSeries

The general meaning of these fields is given in section 1.1 and a full description of all the fields and the values they can take is given in section "4.8.2 XML Imbalance TimeSeries fields".

**2.9.3.8. Excel Imbalance Value**

The Excel file contains one sheet named "000000000000000000": This sheet contains all information about each imbalance component and related criteria's for a given month:

- The top rows contain information about the receiver, the status of the message and the time of creation (last update) of the message and the fact that this sheet follow the Imbalance message format
- Subsequent area of the sheet is divided into columns
- The first lines of the columns give information about the component name, Direction (Power Flow), Party or Area) described in "5.7.1.1 Header"
- The quarter hourly values give the power value and the quality for the mentioned metering data.
- Elia does not guarantee the order of components within the message.

	A	B	C	D	E	F	G	H	I
1	Company	22XBRPB-----0		BRP test					
2	Last Update	14-08-2020		Imbalance					
3	Status	Final							
4	Version	1							
5									
6		Component		CrossBorderExpotTotal		DGOInjection		DGOInjection	
7		Direction		Outgoing		Incoming		Incoming	
8		Description		BRP test		Infrac West (541453199767702817)		RESA (541453199449664358)	
9				Value	Quality	Value	Quality	Value	Quality
10		Monthly energy		1,962,781 KWh	Valid	536,469 KWh	Valid	197,241 KWh	Valid
11		Quarter hourly values							
12		Date	From To	W		W		W	
13									

Example 43 Excel Imbalance message sheet

A full description of all the fields and the values they can take is given in section "5.7 Excel Imbalance messages".

**2.10. Transfer of Energy (ToE) Delivered volumes**

The Transfer of Energy (ToE) Delivered volumes messages provide the volumes of energy delivered by DP<sub>PG</sub> delivery points (former non CIPU), falling under a ToE regime, in the framework of the mFRR & DA/ID service.

**2.10.1. Recipients**

The recipients and delivery frequency of the Transfer of Energy (ToE) Delivered volumes is summarized at section "1.2.8 Regulated messages & message delivery frequency".

### 2.10.2. Accessing Transfer of Energy (ToE) delivered volumes messages

Transfer of Energy (ToE) Delivered volumes messages are delivered on a monthly frequency. The delivery schedule for messages is described in section 1.2.4.

More information on accessing messages is given in Chapter 6.

### 2.10.3. Message content

These messages contain the data for one calendar month.

The structure of the message identifies the BSP/FSP(s), Transfer of Energy (ToE), the time period, all the parameters used to describe the power values and the actual power values. This message content can be delivered in one of three formats; CSV format described here below, XML format described in section 2.10.3.3 and XLSX format described in section 2.10.3.4

#### 2.10.3.1. Transfer of Energy (ToE) delivered volumes Components

The Transfer of Energy (ToE) delivered volumes message gives the Transfer of Energy (ToE) using following facets:

- Delivery direction: Up or Down
- Metering direction: Offtake or Injection
- Detail: Per Delivery Point or total

In detail, following components are available:

Component	Description
TotalToEVolumesUpInjection_DeliveredVolume_PerDeliveryDirection&MeteringDirection	Total volume delivered in the upward direction by the BSP/FSP with the injection counterpart of the delivery points DP <sub>PG</sub> falling under a ToE regime in the framework of the mFRR & DA/ID services (according to the ToE rules)
TotalToEVolumesDownInjection_DeliveredVolume_Total_PerDelivery&MeteringDirection	Total volume delivered in the downward direction by the BSP/FSP with the injection counterpart of the delivery points DP <sub>PG</sub> falling under a ToE regime in the framework of the mFRR & DA/ID services (according to the ToE rules)
TotalToEVolumesUpOfftake_DeliveredVolume_PerDelivery&MeteringDirection	Total volume delivered in the upward direction by the BSP/FSP with the offtake counterpart of the delivery points DP <sub>PG</sub> falling under a ToE regime in the framework of the mFRR & DA/ID services (according to the ToE rules)
TotalToEVolumesDownOfftake_DeliveredVolume_PerDeliveryDirection&MeteringDirection	Total volume delivered in the downward direction by the BSP/FSP with the offtake counterpart of the delivery points DP <sub>PG</sub> falling under a ToE regime in the framework of the mFRR & DA/ID services (according to the ToE rules)
ToEVolumesUpInjection_DeliveredVolumeperDeliveryPoint_PerDelivery&MeteringDirection	Volume by delivery point delivered in the upward direction by the BSP/FSP with the injection counterpart of the delivery points DP <sub>PG</sub> falling under a ToE regime in the framework of the mFRR & DA/ID services (according to the ToE rules)
ToEVolumesDownInjection_DeliveredVolumeperDeliveryPoint_PerDelivery&MeteringDirection	Volume by delivery point delivered in the downward direction by the BSP/FSP with the injection counterpart of the delivery points DP <sub>PG</sub> falling under a ToE regime in the

	framework of the mFRR & DA/ID services (according to the ToE rules)
ToEVolumesUpOfftake_DeliveredVolumeperDeliveryPoint_PerDelivery&MeteringDirection	Volume by delivery point delivered in the upward direction by the BSP/FSP with the offtake counterpart of the delivery points DP <sub>PG</sub> falling under a ToE regime in the framework of the mFRR & DA/ID services (according to the ToE rules)
ToEVolumesDownOfftake_DeliveredVolumeperDeliveryPoint_PerDelivery&MeteringDirection	Volume by delivery point delivered in the downward direction by the BSP/FSP with the offtake counterpart of the delivery points DP <sub>PG</sub> falling under a ToE regime in the framework of the mFRR & DA/ID services (according to the ToE rules)

### 2.10.3.2. CSV Transfer of Energy (ToE) delivered volumes Value

Transfer of Energy (ToE) delivered volumes messages contain a [header] row, a [data] row describing the component and [schedule] sections. An example of a CSV Transfer of Energy (ToE) delivered volumes message is shown below:

```
[header];10X1001A1001A094;22X2example----4;2021-08-11T15:02:36Z;DPBSP;3;Final;10YBE-----2

[data];ToEVolumesDownInjection_DeliveredVolumeperDeliveryPoint_PerDelivery&MeteringDirection;541449200000555507;IN

[schedule];2021-04-29T22:00:00Z;1440;15;A;N;C;ULP;KW;695939;N;469[end]
```

Example 44 CSV Transfer of Energy (ToE) delivered volumes message

The [header] row contains information about the sender and the receiver of the message as well as the time of creation, the version number, state of the message and the fact that this is an Imbalance message. There is only one [header] row in the message. For a complete description of all the [header] fields see section ""

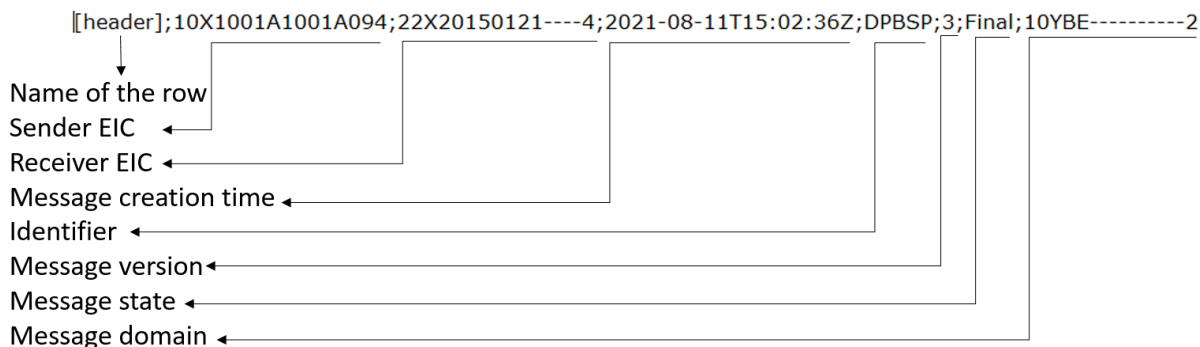

#### 2.10.3.2.1. [data]

A [data] row contains information about the component and related criteria's. A [data] section is always followed by at least one [schedule] section. There are several [data] sections that correspond to different components. For a complete description of all the [data] see section "3.10.1.2 Transfer of Energy (ToE) delivered volumes [data]" p 127.

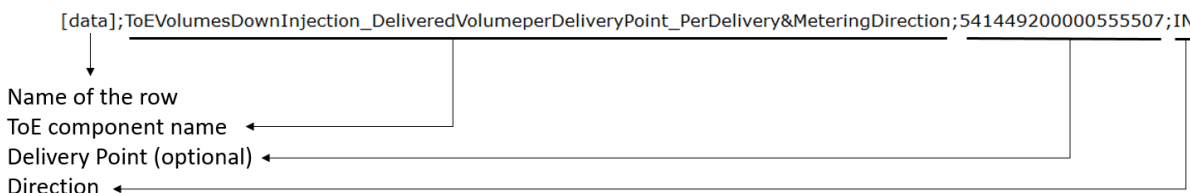

### 2.10.3.2.2. [schedule]

A [schedule] section contains the power values transferred over the specified time period and identifies the type of power. The Time period constitutes 1 day of 23, 24 or 25 hours. For any component identified in the [data] section, there can be a number of schedules. The fields contained in the [schedule] are listed below; the general meaning of these fields can be found in section 1.1 and details of all their possible values can be found in section "3.10.1.3 Transfer of Energy (ToE) delivered volumes [schedule]" p 128 .

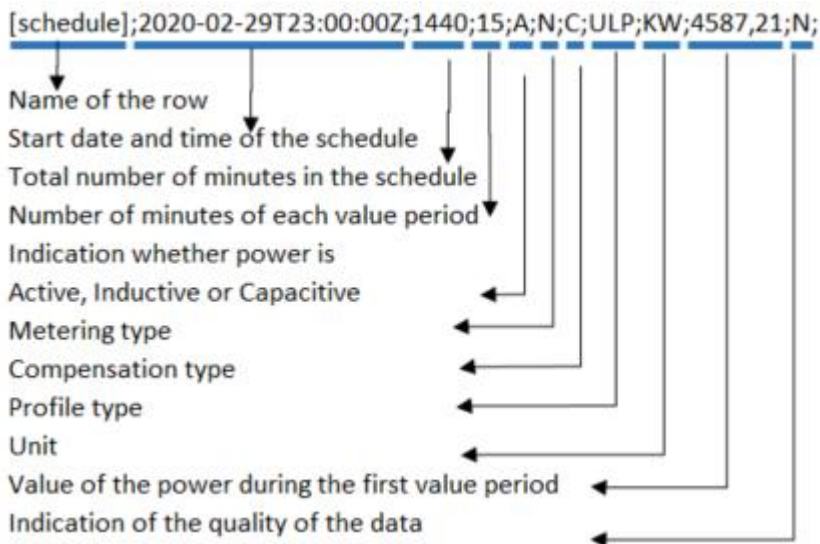

### 2.10.3.3. XML Transfer of Energy (ToE) delivered volumes value

The XML Transfer of Energy (ToE) delivered volumes message has a structure which is completely different of the other metering messages.

The Elia goal is to replace in a near future all the Metering XML messages in order to cope with European and worldwide standards that are available now: the current Imbalance message respects the **IEC standard 62325-451-4**

The structure therefore is briefly explained in this document but whole description is available on the IEC web store: <https://webstore.iec.ch/publication/29116>

The XSD Schema reference is available on "4.1 Reference XSD ".

```

    <EnergyAccount_MarketDocument
    xsi:schemaLocation="urn:iec62325.351:tc57wg16:451-4:energyaccountdocument:4:0
    iec62325-451-4-settlement_v4.xsd" xmlns="urn:iec62325.351:tc57wg16:451-
    4:energyaccountdocument:4:0" xmlns:xsi="http://www.w3.org/2001/XMLSchema-
    instance">

    </EnergyAccount_MarketDocument>
  
```

*Example 45 XML Transfer of Energy (ToE) delivered volumes message root*

The message begins with information about the sender of the message (Elia) and the receiver as well as the time when the message was created plus some information about the state of this message: This header is valid for all the Time Series.

Technical information on each field is available in section 4.9 " XML Transfer of Energy (ToE) delivered volumes " p 156 ".

Remark: the XML comments indicated in the message here below are for the reader comprehension and are available in the message sent by Elia;

```

    <EnergyAccount_MarketDocument
    xsi:schemaLocation="urn:iec62325.351:tc57wg16:451-4:energyaccountdocument:4:0
    iec62325-451-4-settlement.xsd" xmlns="urn:iec62325.351:tc57wg16:451-
    4:energyaccountdocument:4:0" xmlns:xsi="http://www.w3.org/2001/XMLSchema-
    instance">
  
```

```

    <mRID>DPBSP_20200101_20200131</mRID>
    <revisionNumber>1</revisionNumber>
    <type>Z05</type>
    <docStatus>
      <value>A01</value>
    </docStatus>
    <process.processType>Z03</process.processType>
    <process.classificationType>A01</process.classificationType>
    <sender_MarketParticipant.mRID
codingScheme="A01">10X1001A1001A094</sender_MarketParticipant.mRID>
    <sender_MarketParticipant.marketRole.type>
      A04</sender_MarketParticipant.marketRole.type>
    <receiver_MarketParticipant.mRID codingScheme="A01">22X20131122----
9</receiver_MarketParticipant.mRID>
    <receiver_MarketParticipant.marketRole.type>
      R12</receiver_MarketParticipant.marketRole.type>
    <createdDateTime>2020-12-29T17:49:12Z</createdDateTime>
    <period.timeInterval>
      <start>2020-07-31T22:00Z</start>
      <end>2020-08-31T22:00Z</end>
    </period.timeInterval>
    <domain.mRID codingScheme="A01">10YBE-----2</domain.mRID>

```

*Example 46 XML Transfer of Energy (ToE) delivered volumes) message header*

The <TimeSeries> element describes the flow of the power for one component and related criteria and the schedule of actual power values.

Technical information on each field is described in section 4.9 " XML Transfer of Energy (ToE) delivered volumes " p 156.

Elia does not guarantee the order of Timeseries within the message.

```

<TimeSeries>
  <mRID>Z17_541448911000004100</mRID>
  <businessType>Z17</businessType>
  <product>8716867000030</product>
  <MeteringType>A01</MeteringType>
  <CalculationMethod>A01</CalculationMethod>
  <objectAggregation>A01</objectAggregation>
  <area_Domain.mRID
codingScheme="A10">541448911000004100</area_Domain.mRID>
  <measure_Unit.name>KWT</measure_Unit.name>
  <Period>...</Period>
</TimeSeries>

```

*Example 47 XML Transfer of Energy (ToE) delivered volumes message TimeSeries*

The general meaning of these fields is given in section 1.1 and a full description of all the fields and the values they can take is given in section 4.9 " XML Transfer of Energy (ToE) delivered volumes " p 156.

**2.10.3.4. Excel Transfer of Energy (ToE) delivered volumes value**

The Excel file contains two sheets named "Summary" and "Detail": These sheets contain all information about all components and related criteria's for a given month:

- The top rows contain information about the receiver, the status of the message and the time of creation (last update) of the message and the fact that this sheet follow the Imbalance message format
- Subsequent area of the sheet is divided into columns
- The first lines of the columns give information about the component name, Direction (Power Flow), Party or Area)
- The quarter hourly values give the power value and the quality for the mentioned metering data.
- Elia does not guarantee the order of components within the message.

	A	B	C	D	E	F	G	H	I	J	K
1	Company	22XDPBSPEXAMPLE		BSPEXAMPLE							
2	Last Update	11-08-2021									
3	Status	Final		DPBSP							
4	Version	3									
5											
6	Component			TotalToEVolumesUpInjection	TotalToEVolumesUpOfftake		TotalToEVolumesDownInjection		TotalToEVolumesDownOfftake		
7				DeliveredVolume	DeliveredVolume		DeliveredVolume		DeliveredVolume		
8				BSPEXAMPLE	BSPEXAMPLE		BSPEXAMPLE		BSPEXAMPLE		
9	Party			22XDPBSPEXAMPLE	22XDPBSPEXAMPLE		22XDPBSPEXAMPLE		22XDPBSPEXAMPLE		
10											
11	Meterable type			Incoming	Outgoing		Incoming		Outgoing		
12				Active	Active		Active		Active		
13				Net	Net		Net		Net		
14				Compensated	Compensated		Compensated		Compensated		
15											
16				Value	Quality	Value	Quality	Value	Quality	Value	Quality
17	Monthly energy			0 KWh	Valid	188 KWh	Valid	0 KWh	Valid	0 KWh	Valid
18											
19	Quarter hourly values										
20	Date	From	To	W		W		W		W	
21	01-04-2021	00:00	00:15	0	N	0	N	0	N	0	N
22	01-04-2021	00:15	00:30	0	N	0	N	0	N	0	N
23	01-04-2021	00:30	00:45	0	N	0	N	0	N	0	N
24	01-04-2021	00:45	01:00	0	N	0	N	0	N	0	N
25	01-04-2021	01:00	01:15	0	N	0	N	0	N	0	N
26	01-04-2021	01:15	01:30	0	N	0	N	0	N	0	N
27	01-04-2021	01:30	01:45	0	N	0	N	0	N	0	N
28	01-04-2021	01:45	02:00	0	N	0	N	0	N	0	N
29	01-04-2021	02:00	02:15	0	N	0	N	0	N	0	N
30	01-04-2021	02:15	02:30	0	N	0	N	0	N	0	N
31	01-04-2021	02:30	02:45	0	N	0	N	0	N	0	N

Example 48 Excel Transfer of Energy (ToE) delivered volumes message 'Detail' sheet

A full description of all the fields and the values they can take is given in section 5.8 " Excel Transfer of Energy (ToE) delivered volumes " p 209.

## 2.11. Real-Time DGO Allocation

One of the previous section (2.9) introduced the imbalance message. Due to current market processes, in particular the DGO Allocation component (DGOInjectionTotal and DGOOfftakeTotal described in section 2.9.3.1), the imbalance message for month M can be sent at earliest by the end of M+1, usually around M+2.

Based on machine-learning technique, real-time the DGO Allocation are estimated. The estimation algorithm is based on linear regression and uses a specific, per BRP, combination of variables.

$$RT\ DGO\ Alloc\ Estimate_{BRP_i}(qh) = Intercept_{BRP_i} + \sum_{j=1}^N Coeff_{BRP_i}(j) * Variable_j(qh)$$

Figure 14: Linear regression model for Real-Time DGO Allocation Estimation

The variables are grouped in different families (Infeed, Wind Forecast, Solar Forecast...) each variable providing specific details about an element (Infeed at border point A, Infeed at border point B... Wind Forecast for wind farm x, Wind forecast for wind farm Y...). In total, the regression model can use more than 700 variables. Note that these variables are not sent together with the message.

Given the similarity of the Real-Time DGO Allocation to the Imbalance components DGOInjectionTotal and DGOOfftakeTotal, the Real-Time DGO Allocation message is very similar to an imbalance message. For that reason, the Real-Time DGO Allocation is published as a component of an Real-time Imbalance message (very similar to the Imbalance message defined in "2.9 Imbalance") This component is expressed in a single direction (DGONetInjectionEstimateTotal) that can take negative values (in case of net offtake).

Given the fact that this Real-Time DGO Allocation is an estimate made using variables on real-time, it can happen that some of these variables are not available at the moment the estimation has to be made. In such circumstances, the estimation algorithm will nevertheless make an estimation, but of less quality than the estimate with all variables. In order to inform message recipients of such situations, the Real-Time DGO Allocation has a second component, DGONetInjectionEstimateQualityTotal, giving the quality of the estimate in %. A quality of 100% means that all variables required for estimating the Real-Time DGO Allocation were available and used. A quality of less than 100% means that some variables could not be used for making an estimate.

All of the parameters used to describe power values are explained in section 1.1.

### 2.11.1. Recipients

Real-Time DGO Allocation messages are not regulated messages received by the Balance Responsible Parties (BRP).

### 2.11.2. Accessing Real-Time DGO Allocation messages

Real-Time DGO Allocation messages are delivered on a quarter hourly frequency. They can be delivered exceptionally for a complete month on request.

More information on accessing messages is given in Chapter 6.

### 2.11.3. Message content

Real-Time DGO Allocation messages identify the BRP, the time period, all the parameters used to describe the power values, Real Time DGO Allocation Estimate (kW) and the Real Time DGO Allocation Estimate quality (%).

This message content can be delivered in one of three formats:

- CSV format described in "3.11 CSV Real-Time DGO Allocation messages " p 129
- XML format described in "4.10 XML Real-Time DGO Allocation Estimation" p 162
- Excel (XLSX) format described in "5.12 Excel Real-Time DGO Allocation messages" p 228.

This message format is very similar to the Imbalance message (see "2.9 Imbalance"), where the different values for publication are considered as a new imbalance component.



### 2.11.3.1. Real-Time DGO Allocation components

The components that can be presented to the BRP are:

Component	Description	XML Business type
DGOAllocationEstimateTotal	The latest calculated value of the real-time estimate in kW	Z22
DGOAllocationEstimateQuality	The quality of the estimation (percentage)	Z23

### 2.11.3.2. CSV Real-Time DGO Allocation

Real-Time DGO Allocation messages contain a [header] row, a [data] row, [schedule] sections and an [end] row. An example of a CSV Real-Time DGO Allocation message is shown below.

```
[header];10X1001A1001A094;22XTEST-ARP-ARPA;2019-09-14T22:00:00Z;IMBALANCERT;10;Intermediate
[data];DGOAllocationEstimateTotal;22XTEST-ARP-ARPA;OUT
[schedule];2019-09-13T22:00:00Z;1440;15;A;N;C;ALP;KW;-100,05;N;-110,89;N..
[data];DGOAllocationEstimateQuality;22XTEST-ARP-ARPA;OUT
[schedule];2019-09-13T22:00:00Z;1440;15;A;N;C;ALP;%;100,0;N;90,0;N..
...
```

*Example 49 CSV Real-Time DGO Allocation message*

#### 2.11.3.2.1. [header]

The [header] row is the same as the "Imbalance" message and contains information about the sender and the receiver of the message as well as the time of creation, the version number, state of the message and the fact that this is an Imbalance message. There is only one [header] row in the message. For a complete description of all the [header] fields see section "3.11.1.1 Real-Time DGO Allocation [header]".

```
[header];10X1001A1001A094;22XTEST-ARP-ARPA;2019-11-12T11:44:14Z;IMBALANCERT;780
```

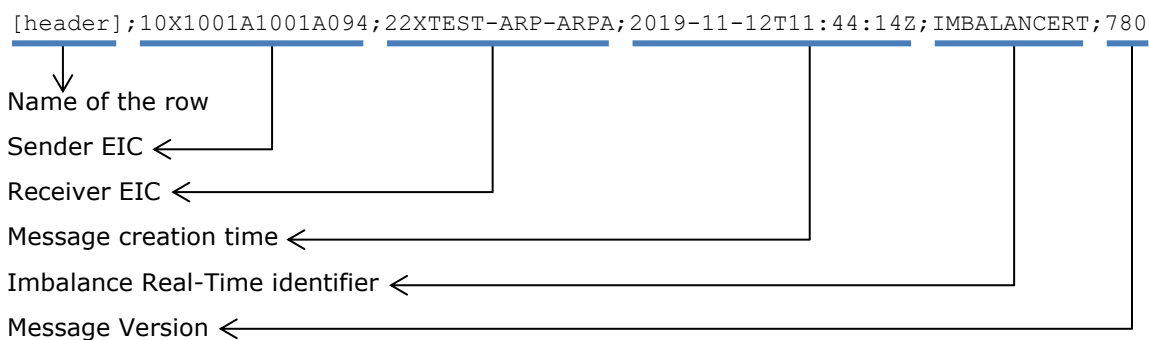

#### 2.11.3.2.2. [data]

A [data] row contains information about the component and related criteria's. A [data] section is always followed by at least one [schedule] section. There are several [data] sections that correspond to different components. For a complete description of all the [data] see section "3.11.1.2 Real-Time DGO Allocation [data]".



```
[data];DGONetInjectionEstimateQuality;000000000000000000;IN
```

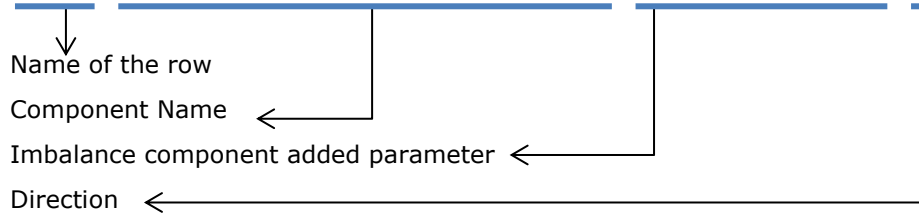

The possible components names for this Real-Time DGO Allocation messages are defined in section "2.11.3.1 Real-Time DGO Allocation components".

### 2.11.3.2.3. [schedule]

A [schedule] section contains the values transferred over the specified time period and identifies the type of value, in the case of Real-Time DGO Estimation it can be either power (KW) or a Estimate Quality (%). The Time period constitutes 1 day of 23, 24 or 25 hours. For any component identified in the [data] section, there can be a number of [schedules]. The fields contained in the [schedule] are listed below; the general meaning of these fields can be found in section 1.1 and details of all their possible values can be found in section "3.11.1.1 Real-Time DGO Allocation [header]".

```
[schedule];2019-10-31T23:00:00Z;1440;15;A;N;C;ALP;%;100;N
```

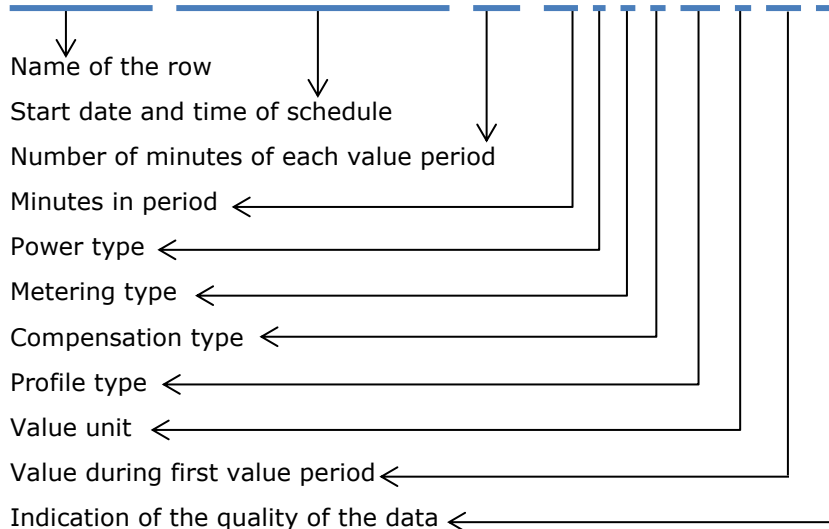

### 2.11.3.3. XML Real-Time DGO Allocation

Real-Time DGO Allocation metering data is delivered in a format like the XML Imbalance message. XML Imbalance message has a structure which is completely different of the other metering messages.

The Real-Time DGO Allocation and Imbalance messages respect the **IEC standard 62325-451-4**

The structure therefore is briefly explained in this document but whole description is available on the IEC web store: <https://webstore.iec.ch/publication/29116>

The XSD Schema reference is available on "4.1 Reference XSD".

```
<EnergyAccount_MarketDocument
xsi:schemaLocation="urn:iec62325.351:tc57wg16:451-4:energyaccountdocument:4:0
iec62325-451-4-settlement_v4.xsd" xmlns="urn:iec62325.351:tc57wg16:451-
4:energyaccountdocument:4:0" xmlns:xsi="http://www.w3.org/2001/XMLSchema-
instance">
</EnergyAccount_MarketDocument>
```

Example 50 XML Real-Time DGO Allocation message root

The message begins with information about the sender of the message (Elia) and the receiver as well as the time when the message was created plus some information about the state of this message: This header is valid for all the Time Series

Technical information on each field is available in "4.10 XML Real-Time DGO Allocation Estimation".

Remark: the XML comments indicated in the message here below are for the reader comprehension and are not available in the message sent by Elia;

```

<mRID>Prediction_20191101_20191130</mRID><revisionNumber>10</revisionNumber>
<type>A12<!-- Imbalance report --></type>
<docStatus><value>A01</value></docStatus><!-- Intermediate -->
<process.processType>A99</process.processType> <!-- DGO Allocation -->
<process.classificationType>A01</process.classificationType> <!-- Detail -->
<sender_MarketParticipant.mRID
codingScheme="A01">10X1001A1001A094</sender_MarketParticipant.mRID>
<sender_MarketParticipant.marketRole.type>A04</sender_MarketParticipant.marke
tRole.type>
<receiver_MarketParticipant.mRID codingScheme="A01">22XBRPA-----
A</receiver_MarketParticipant.mRID>
<receiver_MarketParticipant.marketRole.type>A08</receiver_MarketParticipant.m
arketRole.type> <!-- Balance responsible party -->
<createdDateTime>2019-09-14T22:00:00Z</createdDateTime>
<period.timeInterval>
  <start>2019-09-13T22:00:00Z</start>
  <end>2019-09-14T22:00:00Z </end>
</period.timeInterval>
<domain.mRID codingScheme="A01">10YBE-----2</domain.mRID>

```

#### Example 51 XML Real-Time DGO Allocation message header

The <TimeSeries> element describes the flow of the power for one component and related criteria and the schedule of actual power values.

Technical information on each field is described in section "4.10.2 XML Real-Time DGO Allocation Estimation TimeSeries fields".

Elia does not guarantee the order of Timeseries within the message.

```

<TimeSeries>
  <mRID>A03-22XBRPA-----A</mRID>
  <businessType>Z22</businessType>
  <!-- The latest calculated value of the real-time estimate in KW -->
  <product>8716867000016</product>
  <objectAggregation>A03</objectAggregation>
  <area_Domain.mRID codingScheme="A01">10YBE-----
2</area_Domain.mRID>
  <marketParticipant.mRID codingScheme="A01">22XBRPA-----A
  </marketParticipant.mRID>
  <measure_Unit.name>KWT</measure_Unit.name>
  ...
</TimeSeries>
<TimeSeries>
  <mRID>Z23_22X20121009---F4</mRID>

```

```

        <businessType>Z23</businessType> <!-- The quality of the estimation,
in % -->
        <product>8716867000016</product>
        <MeteringType>A01</MeteringType>
        <CalculationMethod>A01</CalculationMethod>
        <objectAggregation>A03</objectAggregation>
        <area_Domain.mRID codingScheme="A01">22X20121009---
F4</area_Domain.mRID>
        <measure_Unit.name>%</measure_Unit.name>
        ...
    </TimeSeries>
    
```

Example 52 XML Real-Time DGO Allocation message TimeSeries

The general meaning of these fields is given in section 1.1 and a full description of all the fields and the values they can take is given in section "4.10.2 XML Real-Time DGO Allocation Estimation TimeSeries fields" on page 164. The business types for the components are listed in "2.11.3.1 Real-Time DGO Allocation components" .

**2.11.3.4. Excel (XLSX) Real-Time DGO Allocation**

The Excel file contains one sheet. This sheet contains all information about the real-time DGO allocation, both the estimation and estimation quality:

- The top rows contain information about the receiver, the status of the message and the time of creation (last update) of the message and the fact that this sheet follow the Imbalance message format
- Subsequent area of the sheet is divided into columns
- The first lines of the columns give information about the component name, Direction (Power Flow), Party or Area) described "2.11.3.1 Real-Time DGO Allocation components".
  - The quarter hourly values give the power value and the estimated quality percentage for the mentioned metering data

1	Company	A03-22XTEST-ARP-ARP		Test ARP			
2	Last Update	02-08-2020		Prediction			
3	Status	Intermediate					
4	Version	229					
5							
6		Component		DGOAllocationEstimateQuality		DGOAllocationEstimateTotal	
7		Direction		Incoming		Incoming	
8		Description					
9				Value	Quality	Value	Quality
10		Monthly energy		3 K%h	Valid	-413.098 KWh	Valid
11							
12		Quarter hourly values					
13		Date	From To	%		W	
14		01-08-2020	00:00 00:15	100 N		-14.340.000 N	
15		01-08-2020	00:15 00:30	100 N		-14.150.000 N	
16		01-08-2020	00:30 00:45	100 N		-14.140.000 N	
17		01-08-2020	00:45 01:00	100 N		-14.340.000 N	
18		01-08-2020	01:00 01:15	100 N		-13.460.000 N	
19		01-08-2020	01:15 01:30	100 N		-14.220.000 N	
20		01-08-2020	01:30 01:45	100 N		-14.320.000 N	
21		01-08-2020	01:45 02:00	100 N		-13.950.000 N	
22		01-08-2020	02:00 02:15	100 N		-13.670.000 N	
23		01-08-2020	02:15 02:30	100 N		-13.220.000 N	
24		01-08-2020	02:30 02:45	100 N		-13.350.000 N	
25		01-08-2020	02:45 03:00	100 N		-13.410.000 N	
26		01-08-2020	03:00 03:15	100 N		-13.300.000 N	
27		01-08-2020	03:15 03:30	100 N		-13.260.000 N	
28		01-08-2020	03:30 03:45	100 N		-13.070.000 N	
29		01-08-2020	03:45 04:00	100 N		-13.050.000 N	
30		01-08-2020	04:00 04:15	100 N		-12.970.000 N	
31		01-08-2020	04:15 04:30	100 N		-12.750.000 N	
32		01-08-2020	04:30 04:45	100 N		-12.660.000 N	

Example 53 Excel Real-Time DGO Allocation sheet

## 2.12. DGO Border Point and Supply Bay metering

These messages are similar, from a business perspective, as the messages described in "1.2.2.6 Infeed TSO per substation " p 16 and "2.7 Infeed TSO per substation and per supply bay" page 47 combined.

These messages were adapted to fulfill the requirement described in the "UMIG TSO - BR - SE - 02 - Electricity"<sup>3</sup> and in particular the process "Exchange Infeed Measures per Substation - 4.1 (from TSO to CMS)".

### 2.12.1. Recipients

This message will be sent the CMS like described in the MIG TSO 6.0 in the role of MRCO.

At the request of the DGO, this message could also be sent to the DGO in the role of DGO and the MRCO.

The recipients and delivery frequency of this message is summarized at section "1.2.8 Regulated messages & message delivery frequency".

### 2.12.2. Accessing DGO Border Point and Supply Bay messages

DGO Border Point and Supply Bay messages are "regulated" messages and delivered on a daily (non-validated) frequency. The delivery schedule for regulated messages is described in section 1.2.4.

More information on accessing messages is given in Chapter 6 "Accessing messages".

### 2.12.3. Message content

These messages contain the data for one calendar month.

The structure of the message identifies the DGO, the substation (Border Point), the substation supply bay, the time period, all the parameters used to describe the power values and the actual power values. This message content can be delivered in on two formats; XML format described in section 2.12.3.4 and XLSX format described in section 2.12.3.5.

Note: the CSV format is the message defined in "2.6 Infeed TSO per substation " p 43.

#### 2.12.3.1. DGO Border Point and Supply Bay components

The Border Point and Supply bay message has two types of components:

- Border Point
- Supply Bay

In the XML message, the link between the supply bay components and the related border point (to which they are physically connected) can be done through the field "Domain" where the Border Point EAN code is referred.

Component	Description
Border Point	The DGO Border Point represents the total or the part of a substation dedicated to DGO (also called 4.1).
Supply Bay	The Supply Bay represents the individual meters needed to calculate the Border Point. It can be a transformer, a trunk, a capacitor bank or an Elia customer connection.

#### 2.12.3.2. DGO Border point and Supply Bay components criteria

In the following list the columns must be understood as:

**Component:** Indicates whether the data concerns the border point or the supply bay.

---

<sup>3</sup> [www.atrías.be](http://www.atrías.be) > Publications > UMIG > Market Processes > 02 Business Requirements

**Flow direction:** the flow of electricity (see also 1.1.2 Direction).

- **OUT:** the quantity of energy going out the DGO grid (coming in the Elia Grid)
- **IN :** the quantity of energy coming in the DGO grid (coming out of the Elia Grid)

**Possible negative value?** The energy follows the flow indicated within the column 'Flow direction' in the table below. Consequently there can't be negative values for these components.

Component	Flow direction	Possible negative values?
Border Point Injection	Out	No
Border Point Offtake	In	No
Supply Bay Injection	Out	No
Supply Bay Offtake	In	No

### 2.12.3.3. DGO Border point and Supply Bay components added parameters

In the following list the columns must be understood as:

- **Component :** Indicates whether the data concerns the border point or the supply bay
- **Party/area:** Each component can be general and referenced to a company: this is the "party" but some components can be also detailed per "area". For example, a component on a distribution grid has also the grid area code.
- **Code:** This code can be:
  - The BRP EIC code
  - The area code
  - A specific EIC or EAN code

Component	Party/Area	Code
Border Point Offtake	Area	Border Point EAN code
Border Point Injection	Area	Border Point EAN code
Supply Bay Offtake	Area	Supply Bay EAN code
Supply Bay Injection	Area	Supply Bay EAN code

### 2.12.3.4. XML DGO Border Point and Supply Bay (DGOBP) value

The XML DGO Border Point and Supply Bay message has a structure which is completely different of the other metering messages.

The Elia goal is to replace in a near future all the Metering XML messages in order to cope with European and worldwide standards that are available now: the current Imbalance message respects the **IEC standard 62325-451-4**

The structure therefore is briefly explained in this document but whole description is available on the IEC web store: <https://webstore.iec.ch/publication/29116>

The XSD Schema reference is available on "4.1 Reference XSD "page 134

```
<EnergyAccount_MarketDocument
xsi:schemaLocation="urn:iec62325.351:tc57wg16:451-4:energyaccountdocument:4:0
```

```

iec62325-451-4-settlement_v4.xsd" xmlns="urn:iec62325.351:tc57wg16:451-
4:energyaccountdocument:4:0" xmlns:xsi="http://www.w3.org/2001/XMLSchema-
instance">

    </EnergyAccount_MarketDocument>

```

*Example 54 XML DGOBP message root*

The message begins with information about the sender of the message (Elia) and the receiver as well as the time when the message was created plus some information about the state of this message: This header is valid for all the Time Series

Technical information on each field is available in "4.11 XML DGO Border Point and Supply Bay (DGOBP) message" page 166.

Remark: the XML comments indicated in the message here below are for the reader comprehension and are available in the message sent by Elia;

```

<EnergyAccount_MarketDocument
xsi:schemaLocation="urn:iec62325.351:tc57wg16:451-4:energyaccountdocument:4:0
ELIA-iec62325-451-4-settlement.xsd" xmlns="urn:iec62325.351:tc57wg16:451-
4:energyaccountdocument:4:0" xmlns:xsi="http://www.w3.org/2001/XMLSchema-
instance">

    <mRID>BP_20150801_20150802</mRID>

    <revisionNumber>1</revisionNumber>

    <type>A45</type>

    <docStatus>
        <value>A01</value>
    </docStatus>

    <process.processType>A05</process.processType>

    <process.classificationType>A01</process.classificationType>

    <sender_MarketParticipant.mRID
codingScheme="A01">10X1001A1001A094</sender_MarketParticipant.mRID>

    <sender_MarketParticipant.marketRole.type>A04</sender_MarketPar
ticipant.marketRole.type>

    <receiver_MarketParticipant.mRID codingScheme="A01">22XATRIAS--
----A</receiver_MarketParticipant.mRID>

    <receiver_MarketParticipant.marketRole.type>R02</receiver_Marke
tParticipant.marketRole.type>

    <createdDateTime>2016-04-07T22:00:00Z</createdDateTime>

    <period.timeInterval>
        <start>2015-07-31T22:00Z</start>
        <end>2015-08-01T22:00Z</end>
    </period.timeInterval>

    <domain.mRID
codingScheme="A10">541453104512600409</domain.mRID>

    <!--domain = associated information-->

```

*Example 55 XML DGOBP message header*

The <TimeSeries> element describes the flow of the power for one component and related criteria and the schedule of actual power values.

Technical information on each field is available in "4.11 XML DGO Border Point and Supply Bay (DGOBP) message" page 166.

Elia does not guarantee the order of Timeseries within the message.

```

<TimeSeries>

```

```

<mRID>A65|541453104512600409</mRID>
<businessType>A65</businessType>
<product>8716867000016</product>
<MeteringType>A01</MeteringType>
<CalculationMethod>A01</CalculationMethod>
<objectAggregation>A01</objectAggregation>
<area_Domain.mRID
codingScheme="A10">541453104512600409</area_Domain.mRID>
<measure_Unit.name>KWT</measure_Unit.name>
<Period>...</Period>
</TimeSeries>
    
```

Example 56 XML DGOBP message TimeSeries

The general meaning of these fields is given in section 1.1 and a full description of all the fields and the values they can take is given in section "4.11 XML DGO Border Point and Supply Bay (DGOBP) message" page 166.

**2.12.3.5. Excel DGO Border Point and Supply Bay (DGOBP) value**

The Excel file contains two sheets named "BorderPoint" and "Supply Bay": These sheets contain all information about all 'BorderPoint' and 'Supply Bay' and related criteria's for a given month:

- The top rows contain information about the receiver, the status of the message and the time of creation (last update) of the message and the fact that this sheet follow the Imbalance message format
- Subsequent area of the sheet is divided into columns
- The first lines of the columns give information about the component name, Direction (Power Flow), Party or Area
- The quarter hourly values give the power value and the quality for the mentioned metering data.
- Elia does not guarantee the order of components within the message.

	A	B	C	D	E	F	G
1	<b>Company</b>	22XDGO--EXAMPLEG		<b>DGO Example</b>			
2	<b>Last update</b>	31-12-2020		<b>DGO Border Point and Supply Bay</b>			
3	<b>Validation Status</b>	Intermediate					
4	<b>Version</b>	1					
5							
6		<b>Component</b>		<b>SupplyBayOfftake</b>		<b>SupplyBayInjection</b>	
7		<b>Direction</b>		Outgoing		Incoming	
8		<b>Domain</b>		BP 1 name		BP 1 name	
9				541453179072207214		541453179072207214	
10		<b>Party / Area</b>		Supply Bay 11 name		Supply Bay 11 name	
11				541453139750307797		541453139750307797	
12		<b>Meterable type</b>		Active		Active	
13				Net		Net	
14				NonCompensated		NonCompensated	
15							
16				Value	Quality	Value	Quality
17		Monthly energy		0 KWh	Invalid	0 KWh	Invalid
18							
19		Quarter hourly values					
20	Date	From	To	W		W	

Example 57 Excel DGO Border Point and Supply Bay (DGOBP) message 'Detail' sheet

A full description of all the fields and the values they can take is given in

## 2.13. Delta TS report

These messages are similar, from a business perspective, as the xls files currently sent by mail to the DSO's.

These messages were adapted to fulfill the requirement described in the "UMIG TSO - BR - SE - 02 - Electricity"<sup>4</sup> and in particular the process "TS Report (from TSO to CMS)".

The purpose of these messages is to provide the difference between the energy measured by Elia at a Border Point (4.1) and the sum of the energy reported by DGO at the DGO Interconnection Points (4.2) linked to the border Point.

The message provides:

- The energy flow measured by Elia at the DGO Border Point (4.1)
- The energy measured by each DGO at the DGO Interconnection Point (4.2)
- The difference between the components above (4.1 –  $\Sigma$ 4.2). This difference is called "Delta TS" and is actually a kind of "clearing differences"

### 2.13.1. Recipients

This message will be sent the CMS like described in the MIG TSO 6.0 in the role of MRCO.

At the request of the DGO, this message could also be sent to the DGO in the role of DGO.

The recipients and delivery frequency of this message is summarized at section "1.2.8 Regulated messages & message delivery frequency."

### 2.13.2. Accessing Delta TS messages

The delta TS messages are "regulated" messages and delivered on a daily (non-validated) frequency. The delivery schedule for regulated messages is described in section 1.2.4 on page 17.

More information on accessing messages is given in Chapter 6 Accessing messages on page 240.

### 2.13.3. Message content

These messages contain the data for one calendar month.

The structure of the message identifies the DGO(s), the substation (Border Point), the DGO Interconnection Points, the time period, all the parameters used to describe the power values and the actual power values. This message content can be delivered in one of three formats; XML format described in section 2.13.3.4 and XLSX format described in section 2.13.3.5.

#### 2.13.3.1. DeltaTS Components

The Delta TS message has three types of components:

- Delta TS
- Border Point
- Interconnection Point

In the XML message, the link between the Interconnection Point components and the related border point (to which they are physically connected) can be done through the field "Domain" where the Border Point EAN code is referred.

Component	Description
Border Point	The DGO Border Point represents the total or the part of a substation dedicated to DGO (also called 4.1).

<sup>4</sup> [www.atrías.be](http://www.atrías.be) > Publications > UMIG > Market Processes > 02 Business Requirements



Interconnection Point	The interconnection point represents the contractual connection of a DGO to the border point. This is also called 4.2 Below a Border Point there can be one or more Interconnection Point.
Delta TS	The delta TS is the difference between the energy measured by Elia at border point level and the sum of the energy measured by the DGO at the interconnection point level.

**2.13.3.2. DeltaTS Components criteria**

In the following list the columns must be understood as:

**Component:** Indicates whether the data concerns the border point, interconnection point or the delta TS.

**Flow direction:** the flow of electricity (see also 1.1.2 Direction).

- **OUT:** the quantity of energy going out from the transformation station (TS)
- **IN :** the quantity of energy coming in the transformation station (TS)

**Possible negative value?:** Normally the energy follows the flow indicated within the column 'Flow direction' in the table below, but the result of the Delta TS can flow in the other direction. In this case, the quarter value is negative.

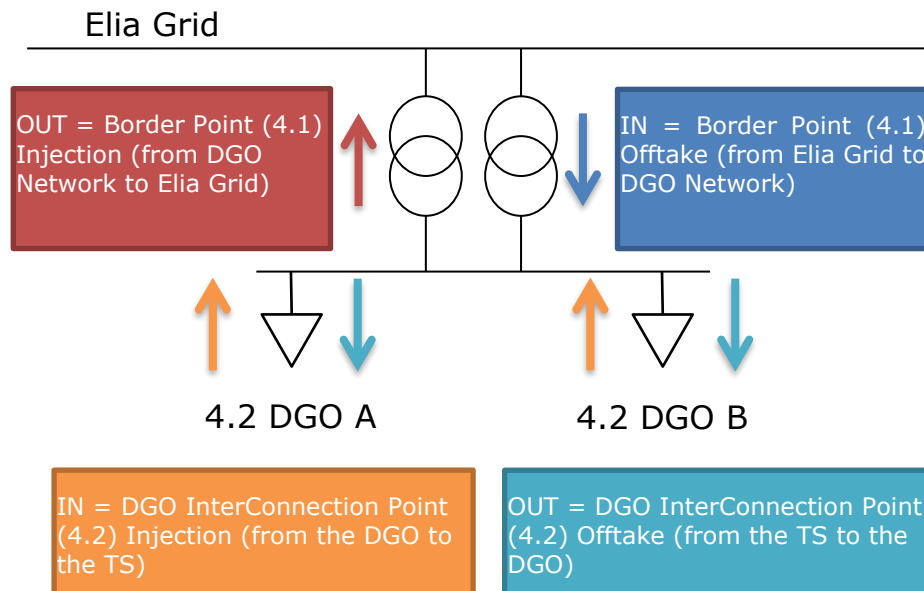

Component	Flow direction	Possible negative values?
Border Point Offtake	In (Elia->TS)	No
Border Point Injection	Out (TS->Elia)	No
DGOInterConnectionPoint Offtake	Out (TS->DGO)	No
DGOInterConnectionPoint Injection	In (DGO->TS)	No
DeltaTS	In	Yes

### 2.13.3.3. DeltaTS Components added parameters

In the following list the columns must be understood as:

- **Component:** Indicates whether the data concerns the border point, interconnection point or the delta TS.
- **Party/area:** Each component can be general and referenced to a company: this is the "party" but some components can be also detailed per "area". For example, a component on a distribution grid has also the grid area code.
- **Code:** This code can be:
  - The BRP EIC code
  - The area code
  - A specific EIC / EAN code

Component	Party/Area	Code
Border Point Injection	Area	Border Point EAN code
Border Point Offtake	Area	Border Point EAN code
DGO Interconnection Point Injection	Area	The DGO Interconnection Point Injection EAN code
DGO Interconnection Point Offtake	Area	The DGO Interconnection Point Offtake EAN code

### 2.13.3.4. XML Delta TS value

The XML Delta TS message has a structure which is completely different of the other metering messages.

The Elia goal is to replace in a near future all the Metering XML messages in order to cope with European and worldwide standards that are available now: the current Imbalance message respects the **IEC standard 62325-451-4**

The structure therefore is briefly explained in this document but whole description is available on the IEC web store: <https://webstore.iec.ch/publication/29116>

The XSD Schema reference is available on "4.1 Reference XSD".

```

<EnergyAccount_MarketDocument
xsi:schemaLocation="urn:iec62325.351:tc57wg16:451-4:energyaccountdocument:4:0
iec62325-451-4-settlement_v4.xsd" xmlns="urn:iec62325.351:tc57wg16:451-
4:energyaccountdocument:4:0" xmlns:xsi="http://www.w3.org/2001/XMLSchema-
instance">

  </EnergyAccount_MarketDocument>

```

*Example 58 XML Delta TS message root*

The message begins with information about the sender of the message (Elia) and the receiver as well as the time when the message was created plus some information about the state of this message: This header is valid for all the Time Series

Technical information on each field is available in "4.12 XML DeltaTS message".

Remark: the XML comments indicated in the message here below are for the reader comprehension and are available in the message sent by Elia;

```

<EnergyAccount_MarketDocument xmlns="urn:iec62325.351:tc57wg16:451-
4:energyaccountdocument:4:0" xmlns:msxsl="urn:schemas-microsoft-com:xslt"
xmlns:csharp="urn:generateGuid/NewGuid">

  <mRID>189EEC4172484643AB3C662BBDEF1963</mRID>

  <revisionNumber>1</revisionNumber>

  <type>Z02</type>

  <docStatus>

```

```

        <value>A02</value>
    </docStatus>
    <process.processType>A05</process.processType>
    <process.classificationType>A01</process.classificationType>
    <sender_MarketParticipant.mRID
codingScheme="A01">10X1001A1001A094</sender_MarketParticipant.mRID>

<sender_MarketParticipant.marketRole.type>A04</sender_MarketParticipant.marke
tRole.type>
    <receiver_MarketParticipant.mRID codingScheme="A01">22XTETS-----
4</receiver_MarketParticipant.mRID>

<receiver_MarketParticipant.marketRole.type>R02</receiver_MarketParticipant.m
arketRole.type>
    <createdDateTime>2020-12-21T06:08:15Z</createdDateTime>
    <period.timeInterval>
        <start>2020-10-31T23:00Z</start>
        <end>2020-11-30T23:00Z</end>
    </period.timeInterval>
    <domain.mRID codingScheme="A10">541453191216677424</domain.mRID>
<EnergyAccount_MarketDocument
xsi:schemaLocation="urn:iec62325.351:tc57wg16:451-4:energyaccountdocument:4:0
ELIA-iec62325-451-4-settlement.xsd" xmlns="urn:iec62325.351:tc57wg16:451-
4:energyaccountdocument:4:0" xmlns:xsi="http://www.w3.org/2001/XMLSchema-
instance">

```

*Example 59 XML Delta TS message header*

The <TimeSeries> element describes the flow of the power for one component and related criteria and the schedule of actual power values.

Technical information on each field is described in section "4.12 XML DeltaTS message".

Elia does not guarantee the order of Timeseries within the message.

```

<TimeSeries>
    <mRID>A65|541416004540000143</mRID>
    <businessType>A65</businessType>
    <product>8716867000016</product>
    <MeteringType>A01</MeteringType>
    <!-- Net -->
    <objectAggregation>A01</objectAggregation>
    <area_Domain.mRID
codingScheme="A10">541416004540000143</area_Domain.mRID>
    <measure_Unit.name>KWT</measure_Unit.name>
    <Period>...</Period>
</TimeSeries>

```

*Example 60 XML DeltaTS message TimeSeries*

The general meaning of these fields is given in section 1.1 and a full description of all the fields and the values they can take is given in section "4.12 XML DeltaTS message".

### 2.13.3.5. Excel Delta TS value

The Excel file contains two sheets named "Summary" and "Detail": These sheets contain all information about all 'DeltaTS', 'BorderPoint' and 'DGOInterconnectionPoint' and related criteria's for a given month:

- The top rows contain information about the receiver, the status of the message and the time of creation (last update) of the message and the fact that this sheet follow the Imbalance message format
- Subsequent area of the sheet is divided into columns
- The first lines of the columns give information about the component name, Direction (Power Flow), Party or Area)
- The quarter hourly values give the power value and the quality for the mentioned metering data.
- Elia does not guarantee the order of components within the message.

	A	B	C	D	E	F	G
1	Company	22XDGO-EXAMPLE3A	DGO Example 3				
2	Last update	21-12-2020	Delta TS				
3	Validation Status	Intermediate					
4	Version	1					
5							
6		Component	BorderPointOfftake	DGOInterconnectionPointOfftake			
7		Direction	Outgoing	Outgoing			
8		Domain	ABCDE 15	ABCDE 15			
9			541453161252993346	54145316125299336			
10		Party / Area	ABCDE 15	ABCDE 15-DGOB			
11			541453161252993346	541453198643130066			
12		Meterable type	Net	Dgo			
13			Active	Active			
14			Compensated	Compensated			
15							
16			Value	Quality	Value	Quality	
17		Monthly energy	20,733,939 KWh	Valid	20,733,939 KWh	Valid	
18							
19		Schedules					
20	Date	From	To	W		W	

Example 61 Excel DeltaTS message 'Detail' sheet

A full description of all the fields and the values they can take is given in section "5.10 Excel Delta TS (DTS) metering messages " p 218.

## 2.14. Delta DGO Exchanges (DGO2DGO) report

These messages are similar, from a business perspective, as the xls files currently sent by mail to the DSO's.

These messages were adapted to fulfill the requirement described in the "UMIG TSO - BR - SE - 02 - Electricity"<sup>5</sup> and in particular the process "Delta Report Exchanges (from TSO to CMS)".

The purpose of these messages is to provide the difference between the energy measured by each of the DGO in a given DGO exchange point (DGO2DGO).

The message provides:

- The energy flow measured by each of the DGO for a given DGO exchange point (DGO2DGO)

<sup>5</sup> [www.atrias.be](http://www.atrias.be) > Publications > UMIG > Market Processes > 02 Business Requirements

- The difference between the energy measured by each of the DGO for a given DGO exchange point (DGO2DGO). This difference is called "Delta DGO Exchanges (DGO2DGO)" and is actually a kind of "clearing differences".

#### 2.14.1. Recipients

This message will be sent the CMS like described in the MIG TSO 6.0 in the role of MRCO.

At the request of the DGO, a summary of these messages could also be sent to the DGO in the role of DGO.

The recipients and delivery frequency of this message is summarized at section "1.2.8 Regulated messages & message delivery frequency".

#### 2.14.2. Accessing Delta DGO Exchanges (DGO2DGO) messages

Delta DGO Exchanges (DGO2DGO) messages are "regulated" messages and delivered on a daily (non-validated) frequency. The delivery schedule for regulated messages is described in section 1.2.4.

More information on accessing messages is given in Chapter 6 Accessing messages.

#### 2.14.3. Message content

These messages contain the data for one calendar month.

The structure of the message identifies the DGO(s), the energy flow measured by each of the DGO in a given DGO exchange point, the difference between the energy measured by each of the DGO in a given DGO exchange point (DGO2DGO), the time period, all the parameters used to describe the power values and the actual power values. This message content can be delivered in one of 2 formats: XML format described in section 2.14.3.4 only for the CMS and XLSX (summary) format described in section 2.14.3.5 (only for the DSO).

##### 2.14.3.1. Delta DGO Exchanges (DGO2DGO) Components

The Delta DGO Exchanges (DGO2DGO) message has two types of components:

- DGO Exchange
- Delta DGO Exchange

In the XML message, the link between the DGO Exchanges components and the related Delta DGO Exchange can be done through the field "Domain" where the pair "DGO A GLN code-DGO B GLN code" is referred.

Component	Description
DGO Exchange	The energy flow reported by one DGO for a given DGO exchange point (DGO2DGO).
Delta DGO Exchange	The difference of the exchange as reported by each of the DGO for a given DGO exchange point (DGO2DGO).

##### 2.14.3.2. Delta DGO Exchanges (DGO2DGO) Components criteria

In the following list the columns must be understood as:

**Component:** Indicates whether the data concerns the DGO Exchange or Delta DGO Exchange.

**Flow direction:** the flow of electricity (see also 1.1.2 Direction).

- **OUT:** the quantity of energy going out the DGO network A (coming in the DGO network B).
- **IN:** the quantity of energy coming in a DGO network A (coming out the DGO network B).

**Possible negative value?:** Normally the energy follows the flow indicated within the column 'Flow direction' in the table below, but the result of the Delta DGO Exchanges can flow in the other direction. In this case, the quarter value is negative.

Component	Flow direction	Possible negative values?
DGO Exchange	Out	No
DGO Exchange	In	No
Delta DGO Exchange	In	Yes

### 2.14.3.3. Delta DGO Exchanges (DGO2DGO) Components added parameters

In the following list the columns must be understood as:

- **Component:** Indicates whether the data concerns the DGO Exchange or Delta DGO Exchange.
- **Party/area:** Each component can be general and referenced to a company: this is the "party" but some components can be also detailed per "area". For example, a component on a distribution grid has also the grid area code.
- **Code:** This code can be:
  - The BRP EIC code
  - The area code
  - A specific EIC / GLN code
- **Market Participant:**
  - The other party participating in the exchange

Component	Party/Area	Code	Market Participant
DGO Exchange	Area	GLN code of the DGO communicating the data	GLN code of the related DGO with which the exchange is made
Delta DGO Exchange	Area	GLN code of the DGO communicating the data	GLN code of the related DGO with which the exchange is made

### 2.14.3.4. XML Delta DGO Exchanges (DGO2DGO) value

The XML Delta DGO Exchanges (DGO2DGO) message has a structure which is completely different of the other metering messages.

The Elia goal is to replace in a near future all the Metering XML messages in order to cope with European and worldwide standards that are available now: the current Imbalance message respects the **IEC standard 62325-451-4**

The structure therefore is briefly explained in this document but whole description is available on the IEC web store: <https://webstore.iec.ch/publication/29116>

The XSD Schema reference is available on "4.1 Reference XSD".

```
<EnergyAccount_MarketDocument
xsi:schemaLocation="urn:iec62325.351:tc57wg16:451-4:energyaccountdocument:4:0
iec62325-451-4-settlement_v4.xsd" xmlns="urn:iec62325.351:tc57wg16:451-
4:energyaccountdocument:4:0" xmlns:xsi="http://www.w3.org/2001/XMLSchema-
instance">
</EnergyAccount_MarketDocument>
```

*Example 62 XML Delta DGO Exchanges (DGO2DGO) message root*

The message begins with information about the sender of the message (Elia) and the receiver as well as the time when the message was created plus some information about the state of this message: This header is valid for all the Time Series

Technical information on each field is available in 4.13 "XML Delta DGO Exchanges (DGO2DGO) message".

Remark: the XML comments indicated in the message here below are for the reader comprehension and are available in the message sent by Elia;

The <TimeSeries> element describes the flow of the power for one component and related criteria and the schedule of actual power values.

Technical information on each field is described in section "4.13 XML Delta DGO Exchanges (DGO2DGO) message" on page 177.

Elia does not guarantee the order of Timeseries within the message.

```

    <EnergyAccount_MarketDocument xmlns="urn:iec62325.351:tc57wg16:451-
4:energyaccountdocument:4:0" xmlns:msxsl="urn:schemas-microsoft-com:xslt"
xmlns:csharp="urn:generateGuid/NewGuid">
        <mRID>F2210616EDAA4CDBA32CF43FC6C210FF</mRID>
        <revisionNumber>1</revisionNumber>
        <type>Z03</type>
        <docStatus>
            <value>A02</value>
        </docStatus>
        <process.processType>A05</process.processType>
        <process.classificationType>A01</process.classificationType>
        <sender_MarketParticipant.mRID
codingScheme="A01">10X1001A1001A094</sender_MarketParticipant.mRID>
        <sender_MarketParticipant.marketRole.type>A04</sender_MarketParticipant.marke
tRole.type>
        <receiver_MarketParticipant.mRID codingScheme="A01">22XTETS-----
4</receiver_MarketParticipant.mRID>
        <receiver_MarketParticipant.marketRole.type>R02</receiver_MarketParticipant.m
arketRole.type>
        <createdDateTime>2020-12-21T06:06:27Z</createdDateTime>
        <period.timeInterval>
            <start>2020-10-31T23:00Z</start>
            <end>2020-11-30T23:00Z</end>
        </period.timeInterval>
        <domain.mRID codingScheme="MIX">5414567999991-
5414490000108</domain.mRID>
        <TimeSeries>
            <mRID>A02|5414490000108-5414567999991</mRID>
            <businessType>A02</businessType>
            <product>8716867000016</product>
            <MeteringType>A01</MeteringType>
            <CalculationMethod>A01</CalculationMethod>
            <objectAggregation>A01</objectAggregation>
            <area_Domain.mRID
codingScheme="A10">5414490000108</area_Domain.mRID>
            <marketParticipant.mRID
codingScheme="A10">5414567999991</marketParticipant.mRID>

```

```

<measure_Unit.name>KWT</measure_Unit.name>

<Period>
  <timeInterval>
    <start>2020-10-31T23:00Z</start>
    <end>2020-11-30T23:00Z</end>
  </timeInterval>
  <resolution>PT15M</resolution>
</TimeSeries>
    
```

Example 63 XML Delta DGO Exchanges (DGO2DGO) message message header and TimeSeries

The general meaning of these fields is given in section 1.1 and a full description of all the fields and the values they can take is given in section 4.13 "XML Delta DGO Exchanges (DGO2DGO) message".

**2.14.3.5. Excel Delta DGO Exchanges (DGO2DGO) value**

The Excel file contains two sheets named "Summary" and "Detail": These sheets contain all information about all 'DeltaDGOExchange' and 'DGOExchange' of a DGO with its neighbour(s) and related criteria's for a given month:

- The top rows contain information about the receiver, the status of the message and the time of creation (last update) of the message and the fact that this sheet follow the Imbalance message format.
- Subsequent area of the sheet is divided into columns.
- The first lines of the columns give information about the component name, Direction (Power Flow), Party or Area).
- The quarter hourly values give the power value and the quality for the mentioned metering data.
- Elia does not guarantee the order of components within the message.

	A	B	C	D	E	F	G
1	Company	22YDGO-----1		DGO A			
2	Last update	21-12-2020		Delta DGO Exchanges (DGO2DGO)			
3	Validation Status	Intermediate					
4	Version	1					
5							
6	<b>Component</b>			<b>DGOExchange</b>		<b>DGOExchange</b>	
7	Direction			Incoming		Outgoing	
8	Domain			DGO A - DGO B		DGO A - DGO B	
9	Party / Area			DGO A		DGO A	
10				5115340458888		5115340458888	
11	<b>Meterable type</b>			Net		Net	
12				Active		Active	
13				Compensated			
14							
15				Value	Quality	Value	Quality
16	Monthly energy			0 KWh	Invalid	3,794 KWh	Invalid
17							
18	Quarter hourly values						
19	Date	From	To	W		W	
20	01-11-2020	00:00	00:15	0	I	9,450	I
21	01-11-2020	00:15	00:30	0	I	7,350	I
22							

Example 64 Excel DGO2DGO message 'Detail' sheet

A full description of all the fields and the values they can take is given in section "5.11 Excel Delta DGO Exchanges (DGO2DGO) metering messages " p 223 .



## 2.15. DGO Loop Losses (DGO PBO) report

These messages are similar, from a business perspective, as the xls files currently sent by mail to the DSO's.

These messages were adapted to fulfill the requirement described in the "UMIG TSO - BR - SE - 02 - Electricity"<sup>6</sup> and in particular the process of control allocation "PBO Report (from TSO to CMS)".

As mentioned in the MIG-TSO 6.0, Elia controls the allocation data and checks that volumes allocated by DGO on a quarter-hourly basis actually correspond to offtakes/injections on the Elia grid.

The result of this allocation control is called "DGO Loop Losses (DGO PBO)" and is actually a kind of "clearing differences". This result is published to the DGO through the "DGO Loop Losses (DGO PBO)" message and to the BRP through the "imbalance message" (see 2.9.3.1 "components").

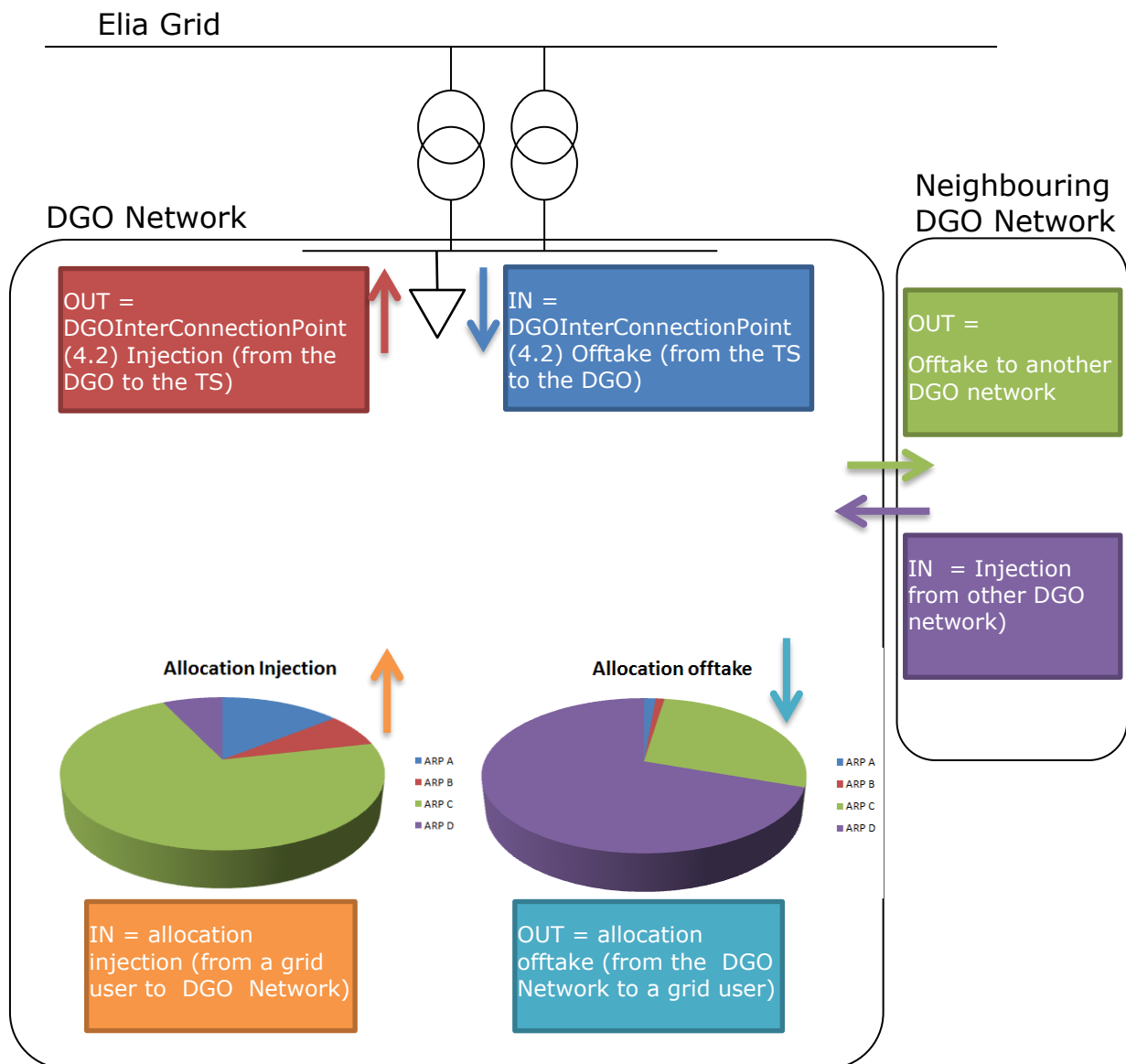

Figure 15: DGO Loop losses (DGO PBO) directions

<sup>6</sup> [www.atrias.be](http://www.atrias.be) > Publications > UMIG > Market Processes > 02 Business Requirements

The "DGO Loop Losses (DGO PBO)" message contains components. A component within a message represents a Business flow. This is the same concept as the components within the Imbalance message (see 2.9.3.1 "Imbalance components")

Each component is supposed well known by the recipient and is published in order to facilitate the analysis in case of error: its detailed business meaning is not described in this document.

The list of possible components is given in "2.15.3.1 DGO Loop Losses (DGO PBO) components".

Each component is considered as having a direction: the "2.15.3.1 DGO Loop Losses (DGO PBO) components " shows the possible direction with following meaning:

- IN = The energy is coming in the DGO Network
- OUT = The energy is going out the DGO Network

Full details on all the descriptive fields and the possible values they can take can be found in section section 2.15.3.4 (for the XML format messages) and section 2.15.3.5 (for the XLSX format messages).

### 2.15.1. Recipients

This message will be sent the CMS like described in the MIG TSO 6.0 in the role of MRCO.

At the request of the DGO, this message could also be sent to the DGO in the role of DGO.

The recipients and delivery frequency of this message is summarized at section "1.2.8 Regulated messages & message delivery frequency.

### 2.15.2. Accessing DGO Loop Losses (DGO PBO) Message

DGO Loop Losses (DGO PBO) messages are "regulated" messages and delivered on a daily (non-validated) frequency. The delivery schedule for regulated messages is described in section 1.2.4.

More information on accessing messages is given in Chapter 6 Accessing messages.

### 2.15.3. Message content

DGO Loop Losses (DGO PBO) messages identify the recipient, the time period, all the parameters of each component used to describe the power values. This message content can be delivered in one of three formats; XML format described in section 2.15.3.4 and Excel (XLSX) format described in section 2.15.3.5.

#### 2.15.3.1. DGO Loop Losses (DGO PBO) components

The business concepts behind each component are explained in MIG TSO 6.0. This manual gives only a short description.

The DGO Loop Losses (DGO PBO) components that are part of the message:

Component	Description
DGOLoopLosses	Loop losses (DGO PBO) of a DGO Network give the result of the allocation control and is given by the following equation: $\sum \text{direction IN} - \sum \text{direction OUT}$ (of sub components explained here below). This component can have as well positive as negative values.
DGOInfeedOfftakeTotal	Total energy coming from Elia network to DGO network through the Interconnection Points ( $\sum$ of the 4.2 offtake)
DGOInfeedInjectionTotal	Total energy coming from the DGO network to Elia network the Interconnection Points ( $\sum$ of the 4.2 offtake)
DGOAllocationOfftakeTotal	Total of allocations offtake for a DGO Network (OUT = means energy coming from the DGO to the BRP)
DGOAllocationInjectionTotal	Total of allocations injection for a DGO Network (IN = means energy coming from the BRP to the DGO)
DGOExchangeOfftakeTotal	Total offtake of DGO exchange point (DGO2DGO)

	(IN = from a Neighbouring DGO Network to the concerned DGO network)
DGOExchangeInjectionTotal	Total injection of DGO exchange point (DGO2DGO) (OUT = from the concerned DGO network to a Neighbouring DGO Network)

Remarks:

This list could vary if new components of the DGO Loop Losses (DGO PBO) are identified or some components removed following the contract of the DGO or new market rules.

It is highly recommended that the system that will read the message has not to be based on the order of the components but on the components criteria's explained here below.

In the XML message, the link between the different components and the related DGO network on which they refer can be done through the field "Domain" where the DGO Network EAN code is referred.

### 2.15.3.2. DGO Loop losses (DGO PBO) components criteria

In the following list the columns must be understood as:

- **Component** : See "2.15.3.1 DGO Loop Losses (DGO PBO) components" page 94
- **Flow direction**: the flow of energy within the DGO Network: See beginning of this section.
- **Possible negative value?**: Normally the energy follows the flow indicated within the column 'Flow direction' in the table below, but the result of the allocation control can flow in the other direction. In this case, the quarter value is negative.

Component	Flow direction	Possible negative values?
DGOLoopLosses	In	Yes
DGOInfeedOfftakeTotal	In	No
DGOInfeedInjectionTotal	Out	No
DGOAllocationOfftakeTotal	Out	No
DGOAllocationInjectionTotal	In	No
DGOExchangeOfftakeTotal	In	No
DGOExchangeInjectionTotal	Out	No

### 2.15.3.3. DGO Loop losses (DGO PBO) components added parameters

Each component of the DGO Loop Losses (DGO PBO) message concerns the DGO area and refers to its DGO network EAN (these EAN codes are also used in the nomination system).

See [https://www.elia.be/-/media/project/elia/elia-site/customers/customer-tools/metering/3\\_list\\_of\\_eans\\_of\\_active\\_distribution\\_system\\_operators\\_en.pdf](https://www.elia.be/-/media/project/elia/elia-site/customers/customer-tools/metering/3_list_of_eans_of_active_distribution_system_operators_en.pdf) for the complete list.

### 2.15.3.4. XML DGO Loop losses (DGO PBO)

The XML DGO Loop Losses (DGO PBO) message has a structure which is completely different of the "Classic" metering messages (as the Access Point).

The Elia goal is to replace in a near future all the Metering XML messages in order to cope with European and worldwide standards that are available now: the current Imbalance message respects the **IEC standard 62325-451-4**

The structure therefore is briefly explained in this document but whole description is available on the IEC web store: <https://webstore.iec.ch/publication/29116>

The XSD Schema reference is available on "4.1 Reference XSD".

```
<EnergyAccount_MarketDocument
xsi:schemaLocation="urn:iec62325.351:tc57wg16:451-4:energyaccountdocument:4:0
iec62325-451-4-settlement_v4.xsd" xmlns="urn:iec62325.351:tc57wg16:451-
4:energyaccountdocument:4:0" xmlns:xsi="http://www.w3.org/2001/XMLSchema-
instance">
</EnergyAccount_MarketDocument>
```

*Example 65 XML DGO Loop losses (DGO PBO) message root*

The message begins with information about the sender of the message (Elia) and the receiver as well as the time when the message was created plus some information about the state of this message: This header is valid for all the Time Series

Technical information on each field is available in "4.14 XML DGO Loop Losses (DGO PBO) messages".

Remark: the XML comments indicated in the message here below are for the reader comprehension and can be not available in the message sent by Elia;

```
<EnergyAccount_MarketDocument
xsi:schemaLocation="urn:iec62325.351:tc57wg16:451-4:energyaccountdocument:4:0
ELIA-iec62325-451-4-settlement.xsd" xmlns="urn:iec62325.351:tc57wg16:451-
4:energyaccountdocument:4:0" xmlns:xsi="http://www.w3.org/2001/XMLSchema-
instance">

    <mRID>EE2C5627CD6143B2BEF774F93AF128F7</mRID>

    <revisionNumber>1</revisionNumber>

    <type>Z01</type>

    <docStatus>
        <value>A01</value>
    </docStatus>

    <process.processType>A05</process.processType>
    <process.classificationType>A01</process.classificationType>

    <sender_MarketParticipant.mRID
codingScheme="A01">10X1001A1001A094</sender_MarketParticipant.mRID>
    <sender_MarketParticipant.marketRole.type>A04</sender_MarketPar
ticipant.marketRole.type>

    <receiver_MarketParticipant.mRID codingScheme="A01">22XDGOB----
----6</receiver_MarketParticipant.mRID>
    <receiver_MarketParticipant.marketRole.type>R06</receiver_Marke
tParticipant.marketRole.type>

    <createdDateTime>2016-04-07T22:00:00Z</createdDateTime>

    <period.timeInterval>
        <start>2015-07-31T22:00Z</start>
        <end>2015-08-01T22:00Z</end>
    </period.timeInterval>

    <domain.mRID codingScheme="A10">541453104512600461</domain.mRID>
```

*Example 66 XML DGO Loop Losses (DGO PBO) message header*

The <TimeSeries> element describes the flow of the power for one component and related criteria and the schedule of actual power values.

Technical information on each field is described in section **Error! Reference source not found. "Error! Reference source not found."**.

```

<TimeSeries>
    <mRID>A66_541453104512600461</mRID>
    <businessType>A66</businessType>
    <!--=Energy flow-->
    <product>8716867000016</product>
    <!-- Active power -->
    <objectAggregation>A01</objectAggregation>
    <area_Domain.mRID
codingScheme="A01">541453104512600461</area_Domain.mRID>
    <measure_Unit.name>KWT</measure_Unit.name>
    <Period>...</Period>
</TimeSeries>
    
```

Example 67 XML DGO Loop losses (DGO PBO) message TimeSeries

The general meaning of these fields is given in section 1.1 and a full description of all the fields and the values they can take is given in section **Error! Reference source not found. "Error! Reference source not found."**.

### 2.15.3.5. Excel DGO Loop Losses (DGO PBO) value

The Excel file contains many sheets:

- One sheet named "Summary"
- One sheet per DGO

These sheets contain all information about all componets given in section "2.5.3.1 CDS Loop Losses (PBO) components " p 38, and related criteria's for a given month:

- The top rows contain information about the receiver, the status of the message and the time of creation (last update) of the message and the fact that this sheet follow the Imbalance message format.
- Subsequent area of the sheet is divided into columns.
- The first lines of the columns give information about the component name, Direction (Power Flow), Party or Area).
- The quarter hourly values give the power value and the quality for the mentioned metering data.
- Elia does not guarantee the order of components within the message.

	A	B	C	D	E	F	G
1	Company	22XDGO-EXAMPLE3A		DGO Example 3			
2	Last update	21-12-2020		DGO Loop Losses (DGO PBO)			
3	Validation Status	Intermediate					
4	Version	1					
5							
6			Component	DGOLoopLosses		DGOLoopLosses	
7			Direction	Incoming		Incoming	
8			Domain	IMEWO		Fluvius Antwerpen	
9				541453174796694517		541453182932680843	
10			Party / Area	IMEWO		Fluvius Antwerpen	
11				541453174796694517		541453182932680843	
12			Meterable type	Active		Active	
13				Net		Net	
14				Compensated		Compensated	
15							
16				Value	Quality	Value	Quality
				Fluvius Antwerpen		Fluvius Limburg	IMEWO

*Example 68 Excel DGO Loop Losses message 'Summary' sheet*

A full description of all the fields and the values they can take is given in section "5.3 Excel CDS Loop Losses (PBO) messages " p 200

## 2.16. DGO Reactive Area and Supply Bay (DGO RA)

### 2.16.1. Recipients

This message will be sent to the CMS in the role of MRCO.

At the request of the DGO, this message could also be sent to the DGO in the role of DGO.

The recipients and delivery frequency of this message is summarized at section "1.2.8 Regulated messages & message delivery frequency.

### 2.16.2. Accessing DGO Reactive Area and Supply Bay (DGO RA) Message

'DGO Reactive Area and Supply Bay metering' messages are delivered on a monthly basis. The delivery schedule for regulated messages is described in "1.2.8 Regulated messages & message delivery frequency " page 19.

More information on accessing messages is given in Chapter 6 Accessing messages.

### 2.16.3. Message content

'DGO Reactive Area and Supply Bay metering' messages identify the receiver, the time period, all the parameters of each component used to describe the power values. This message content can be delivered in one of three formats:

- CSV described in section 2.9.3.1 below,
- XML format described in section 2.16.3.3 XML 'DGO Reactive Area and Supply Bay metering' message " p 99 and
- Excel (XLSX) format described in section "2.16.3.4 Excel 'DGO Reactive Area and Supply Bay metering' message " p 100

#### 2.16.3.1. 'DGO Reactive Area and Supply Bay metering' components

Please note that even if some components are named a "Reactive Area", the metering can be Active, Capacitive or Inductive. This is explained in detail on the different formats.

The 'DGO Reactive Area and Supply Bay metering' message components are:

Component	Description	XML Business Type
ReactiveAreaOfftake	The metering going from the Elia Grid to the DGO Area	A14
ReactiveAreaInjection	The metering going from a DGO Area to the Elia Grid	A14
SupplyBayOfftake	Metering at the Supply Bay going from the Elia Grid to the DGO Area	Z28
SupplyBayInjection	Metering at the Supply Bay going from a DGO Area to the Elia Grid	Z28

#### Remarks:

- This list can always vary when new components of the 'DGO Reactive Area and Supply Bay metering' could be created based on new market rules.
- Elia does not guarantee the order of components within the message.
- All the quarter hourly values are  $\geq 0$
- In XML, Incoming and Outgoing values are put in one Element in XML while they are put on different components in Excel.

### 2.16.3.2. CSV 'DGO Reactive Area and Supply Bay metering' message

The 'DGO Reactive Area and Supply Bay metering' message is not available in CSV format

### 2.16.3.3. XML 'DGO Reactive Area and Supply Bay metering' message

The XML 'DGO Reactive Area and Supply Bay metering' message has the same structure as the Imbalance message (See "2.9.3.7 XML Imbalance" p 68 ).

The Elia goal is to replace in the future all the Metering XML messages in order to cope with European and worldwide standards that are available now: the current 'DGO Reactive Area and Supply Bay metering' respect the same format as the Imbalance message: the **CIM IEC standard 62325-451-4**

The XML Schema (XSD) reference is available on "4.1 Reference XSD".

```
<EnergyAccount_MarketDocument
xsi:schemaLocation="urn:iec62325.351:tc57wg16:451-4:energyaccountdocument:4:0
iec62325-451-4-settlement_v4.xsd" xmlns="urn:iec62325.351:tc57wg16:451-
4:energyaccountdocument:4:0" xmlns:xsi="http://www.w3.org/2001/XMLSchema-
instance">
</EnergyAccount_MarketDocument>
```

*Example 69 XML message root*

The message begins with information about the sender of the message (Elia) and the receiver (DGO or MRCo) as well as the time when the message was created plus some information about the state of this message: This header is valid for all the Time Series

Technical information on each field is available in 4.15 XML DGO Reactive Area and Supply Bay metering message p 186

Remark: the XML comments indicated in the message here below are for the reader comprehension and are available in the message sent by Elia;

```
<mRID>DRA_20150801_20150831</mRID>
<revisionNumber>10</revisionNumber>
<type>Z07</type> <!-- DGO Reactive Area and Supply Bay metering --></
<docStatus><value>A02</value></docStatus><!--Final-->
<process.processType>A06</process.processType> <!--Imbalance settlement-->
<process.classificationType>A01</process.classificationType> <!--Detail-->
<sender_MarketParticipant.mRID
codingScheme="A01">10X1001A1001A094</sender_MarketParticipant.mRID>
<sender_MarketParticipant.marketRole.type>A04</sender_MarketParticipant.marke
tRole.type>
<receiver_MarketParticipant.mRID codingScheme="A01">22XDGO-EXAMPLE3A
</receiver_MarketParticipant.mRID>
<receiver_MarketParticipant.marketRole.type>A08</receiver_MarketParticipant.m
arketRole.type>
<createdDateTime>2015-09-14T22:00:00Z</createdDateTime>
<period.timeInterval>
  <start>2015-07-31T22:00Z</start>
  <end>2015-08-30T22:00Z</end>
</period.timeInterval>
<domain.mRID codingScheme="A01">10YBE-----2</domain.mRID>
```

*Example 70 XML DGO Reactive Area and Supply Bay metering message header*

The <TimeSeries> element describes the flow of the power for one component and related criteria and the schedule of actual power values.

Technical information on each field is described in section "4.8.2 XML Imbalance TimeSeries fields".

Elia does not guarantee the order of Timeseries within the message.

```

<TimeSeries>
  <mRID>A145414531700954616078716867000016</mRID>
  <businessType>A14</businessType>
  <product>8716867000016</product>
  <objectAggregation>A03</objectAggregation>
  <area_Domain.mRID codingScheme="A01">541453170095461607
</area_Domain.mRID>
  <measure_Unit.name>KWT</measure_Unit.name>
  <Period>
</TimeSeries>
    
```

Example 71 XML Imbalance message TimeSeries

The general meaning of these fields is given in section 1.1 and a full description of all the fields and the values they can take is given in section "4.15.2 XML DGO Reactive Area and Supply Bay metering TimeSeries fields " p 188

**2.16.3.4. Excel 'DGO Reactive Area and Supply Bay metering' message**

The Excel file contains 2 sheets. These sheets contain all information about each component and related criteria's for a given month:

- The top rows contain information about the receiver, the status of the message and the time of creation (last update) of the message and the fact that this sheet follow the Imbalance message format
- Subsequent area of the sheet is divided into columns
- The first lines of the columns give information about the component name, Direction (Power Flow), Party or Area)
- The quarter hourly values give the power value and the quality for the mentioned metering data.
- Elia does not guarantee the order of components within the message.

	A	B	C	D	E
1	<b>Company</b>	11X11111111----B		<b>DGO Name</b>	
2	<b>Meterable</b>	541453170095461607		<b>DGO Reactive Area name</b>	
3	<b>Last update</b>	18-06-2020			
4	<b>Validation St:</b>	Final			
5	<b>Version</b>	1			
6					
7		<b>Component</b>		<b>ReactiveAreaOfftake</b>	<b>Reac</b>
8		<b>Direction</b>		Outgoing	
9		<b>Domain</b>		DGO Reactive Area name	DGO F
10				541453170095461607	5414
11		<b>Party / Area</b>		DGO Reactive Area name	DGO F
12				541453170095461607	5414
13		<b>Meterable type</b>		Active	
14				Net	
15				Compensated	
16					
17				Value	Quality
18		<b>Monthly energy</b>		2,504,304 KWh	Valid
					600,8

Example 72 Excel Imbalance message sheet

A full description of all the fields and the values they can take is given in "5.14 Excel DGO Reactive Area and Supply Bay metering messages" p 234.





## Chapter 3 CSV format messages

This chapter describes in detail the content of CSV format messages. This information is destined for the developer implementing this data into a business application.



### Warning

When implementing business applications using metered data, you should take account of day-light saving issues as explained in section 6.5.2 on page 246.

In terms of Elia metering messages, a CSV file is:

- A standard ASCII file composed of 0 or more lines.
- Each line (or record) is terminated by a CRLF (Carriage Return, LineFeed) (ASCII code 13, ASCII code 10)
- A line is composed of a series of fields.
- Each field in the line (or record) is delimited by a recognizable character, most commonly the semi-colon ";" (ASCII code 59)
- The end of the file is indicated by a line with single field [end].

**Note:** The data may be followed by one or more carriage-return or blank characters. All characters after the [end] field must be ignored by the client application parsers.

All messages listed in Chapter 2 are delivered in CSV format.

### 3.1. CSV Access Point messages

This message concerns the metering data related to a specific Access Point. Access Point messages are regulated messages. For a general explanation of the content of these messages see section 2.1.

An example of CSV format Access Point message is shown in the example below. This example contains three [data] sections each referring to different power types (Active, Capacitive, and Inductive) at one Access Point.

Note that the presentation of this example illustrates the overall structure of the message rather than the complete contents. Only the first of the power values is shown in each of the [schedule] sections.

```
[header];10X1001A1001A094;22XXXXXXXXXXXXXC;2005-06-08T06:03:17+02:00
[data];10X1001A1001A094;CONS;541453105585999982
[schedule];2005-06-06T22:00:00Z;1440;15;A;N;NC;ALP;W;False; 0;N; 0;N; 0;N;
. . . {series of data values - not all shown}. . .
0;N; 0;N; 0;N
[data];10X1001A1001A094;CONS;541453105585999982
[schedule];2005-06-06T22:00:00Z;1440;15;C;N;NC;ALP;VAR;False; 0;N; 0;N; .
. . {series of data values - not all shown}. . . 0;N; 0;N; 0;N; 0;N
[data];10X1001A1001A094;CONS;541453105585999982
[schedule];2005-06-06T22:00:00Z;1440;15;I;N;NC;ALP;VAR;False; 0;N; 0;N; .
. . {series of data values - not all shown}. . .
[end]
```

*Example 73 Fields in a CSV Access Point message*

#### 3.1.1. Message structure

The Access Point Message consists of the following sections:

- a [header] section described on page 103.
- [data] sections described on page 103.
- [schedule] sections described on page 103.

- [end] – which is the last line indicating the end of the message. All characters following [end] must be ignored.

### 3.1.1.1. AP [header]

The [header] contains information about the parties involved in the message. This is the first line of the file and appears only once.

Field	Name	Data type	Comment
1	Name of the row	String	Fixed. Always [header]
2	Sender identification code	String	EIC company code of the sender of the message i.e. Elia
3	Receiver identification code	String	EIC company code of the receiver of the message.
4	Message creation time	Date	Date and time of the file creation in Iso format (see section Appendix E, page 258).
5	Message type	String (optional)	This optional field is reserved for future use but may contain the type of message.
6	Version	String (optional)	This optional field is reserved for future use but may contain the version of the message.

Table 2 CSV Access Point [header] fields

### 3.1.1.2. AP [data]

The [data] section is composed of one line. It identifies the source of the metering data, the Access Point at which the data is metered and the energy direction. A message can contain 1 or more [data] sections. Each [data] section can have 1 or more [schedule] sections.

Field	Name	Data type	Comment
1	Name of the row	String	Fixed. Always [data]
2	Source identification code	String	EIC company code of the source of the metering data (Elia)
3	Direction of transfer	String	Identification of the direction of flow (see section 1.1.2). Possible values are: - PROD: Production of active energy (flow from client to Elia) - CONS: Consumption of active energy (flow from Elia to client)
4	Access Point identification code	String	EAN (18-digit) code of the Access Point at which the data is metered.

Table 3 CSV Access Point [data] fields

### 3.1.1.3. AP [schedule]

The [schedule] section contains the metering values and their quality. A [schedule] is always related to a parent [data] section. Each [data] section can have 1 or more [schedule] sections. The schedules are normally daily schedules, but any time period is theoretically possible.

Only positive power values are allowed in the Access Point message.

Field	Name	Data type	Comment
-------	------	-----------	---------

1	Name of the row	String	Fixed. Always [schedule]
2	Start date and time	Date	Start date and time of the schedule in ISO 8601 format (see section "4.17 Data types "page195 ).
3	Duration	Integer	Total number of minutes in the schedule. (! See also section Appendix E, page 258 on the effect of daylight saving).
4	Period	Integer	Number of minutes for each value period. Always 15.
5	Power type	String	Identification of the type of power (see section 1.1.1). Possible values are: <ul style="list-style-type: none"> <li>• A: Active</li> <li>• I: Inductive</li> <li>• C: Capacitive</li> </ul>
6	Metering type	String	Indication as to whether the values are net, gross or specific (see section 1.1.3.4). Possible values are: <ul style="list-style-type: none"> <li>• N: Net</li> <li>• G: Gross</li> <li>• GG: "Green Gross"</li> <li>• GC: "Gross CIPU"</li> </ul>
7	Compensation type	String	Indication as to whether the values compensated or not (see section 1.1.3.1). Possible values are: <ul style="list-style-type: none"> <li>• NC: Non-Compensated. Used for metering purposes.</li> <li>• C: Compensated. Used for billing purposes</li> <li>• A: Reserved for future use</li> <li>• CC: Compensated Corrected Used for specific purposes</li> </ul>
8	Profile type	String	Indication of the load profile. This field is reserved for possible future use and has no significant meaning. Possible values are: <ul style="list-style-type: none"> <li>• ALP: Aggregated Load Profile</li> <li>• ULP: Undefined load profile</li> </ul>
9	Power unit	String	Unit in which the power values are defined. Possible values are: <ul style="list-style-type: none"> <li>• KWT, KVR,</li> <li>• W, KW, MW,</li> <li>• VAR, KVAR, MVAR</li> </ul>
10	Validation	Boolean	Indication as to whether the values are valid or not (see section 1.2.3). Possible values are: <ul style="list-style-type: none"> <li>• True: validated by Elia</li> <li>• False: not validated by Elia</li> </ul>
11 to 203 in	Value	Unsigned Decimal	Value of the transferred power. The value is always positive. The value is expressed in the

steps of 2			defined unit and contains a maximum of 3 digits after the decimal point.
12 to 204 in steps of 2	Quality	1 char	Indication as to the quality of the metered data (see section 1.1.3.3). Possible values are: <ul style="list-style-type: none"> <li>• N: Normal</li> <li>• I: Inexact</li> <li>• S: Substituted (Estimated replacement).</li> </ul>

Table 4 CSV Access Point [schedule] fields

### 3.2. CSV Service Point messages

Service Point messages follow the same structure as Metering Points. See "3.3 CSV Metering Point messages" page 105.

### 3.3. CSV Metering Point messages

For a general explanation of the content of these messages see "2.3.2 Accessing Metering Point messages" p 29

An example of a Metering Point message containing temperature values is shown below.

Note that the presentation of this example illustrates the overall structure of the message rather than the complete contents. Only the first of the power values is shown in each of the [schedule] sections.

```
[header];10X1001A1001A094;11XXXXXXXXXXL--Z;2007-02-14T07:59:54+01:00
[data];10X1001A1001A094;CONS;541453118449038266
[schedule];2007-01-22T23:00:00Z;1440;15;;;ALP;°C;False;-.558;N;-.581;N;-.654;N;-.647;N;-.679;N;-.706;N;-.685;N;-.719;N;-.829;N;-.928;N;-.949;N;-1;N;-.999;N;-.979;N;-1.083;N;-1.163;N;-1.167;N;-1.157;N;-1.157;N;-1.201;N;-1.208;N;-1.259;N;-1.534;N;-1.707;N;-1.862;N;-1.864;N;-1.884;N;-1.867;N;-1.876;N;-1.854;N;-1.872;N;-1.83;N;-1.798;N;-1.831;N;-1.688;N;-1.556;N;-1.492;N;-1.452;N;-1.338;N;-1.273;N;-1.17;N;-1.03;N;-.834;N;-.644;N;-.527;N;-.407;N;-.328;N;-.424;N;-.443;N;-.497;N;-.367;N;-.198;N;-.126;N;-.091;N;-.065;N;.008;N;.231;N;.312;N;.431;N;.684;N;.639;N;.65;N;.825;N;.898;N;.847;N;.829;N;.776;N;.687;N;.566;N;.429;N;.27;N;.06;N;-.121;N;-.176;N;-.195;N;-.256;N;-.284;N;-.271;N;-.342;N;-.37;N;-.456;N;-.325;N;-.213;N;-.11;N;.111;N;.074;N;.194;N;.203;N;.057;N;.001;N;-.09;N;-.198;N;-.294;N;-.481;N;-.524;N;-.477;N
[schedule];2007-01-23T23:00:00Z;1440;15;;;ALP;°C;False;-.115;N;-.42;N;-.577;N;-.566;N;-.152;N;-.009;N;-.413;N;-.552;N;-.626;N;-.473;N;-.26;N;-.407;N;-.269;N;-.492;N;-.613;N;-.689;N;-.401;N;-.478;N;-.4;N;.085;N;.357;N;.354;N;.327;N;-.101;N;.324;N;.534;N;-.015;N;-.243;N;-.186;N;-.11;N;-.185;N;-.244;N;-.114;N;-.009;N;.052;N;-.07;N;-.352;N;-.397;N;-.264;N;-.156;N;.037;N;.006;N;.109;N;.415;N;.922;N;1.585;N;1.722;N;2.12;N;2.911;N;3.286;N;3.381;N;2.997;N;3.184;N;3.544;N;2.991;N;2.756;N;2.951;N;3.273;N;3.133;N;3.067;N;3.075;N;3.144;N;3.217;N;3.211;N;3.068;N;3.043;N;2.43;N;1.704;N;1.484;N;1.054;N;.672;N;.269;N;.106;N;.134;N;.282;N;.478;N;.493;N;-.352;N;-.546;N;-.674;N;-.915;N;-1.138;N;-1.208;N;-1.521;N;-1.591;N;-1.933;N;-1.913;N;-1.821;N;-2.041;N;-2.038;N;-2.072;N;-2.056;N;-2.118;N;-2.316;N;-2.266;N;-2.204;N
[end]
```

Example 74 Fields in a CSV Metering Point message

### 3.3.1. Message structure

The Metering Point Message consists of the following sections:

- [header] section described on page 106.
- [data] sections described on page 106.
- [schedule] sections described on page 107.
- [end] – which is the last line indicating the end of the message. All characters following [end] must be ignored.

#### 3.3.1.1. Metering Point [header]

The [header] contains information about the parties involved in the message. This is the first line of the file and appears only once.

Field	Name	Data type	Comment
1	Name of the row	String	Fixed. Always [header]
2	Sender identification code	String	EIC code (Energy Identification Code) of the TSO (Elia)
3	Receiver identification code	String	EIC code (Energy Identification Code) of the receiver of the message
4	Message creation time	Date	Date and time of the file creation in Iso format (see section Appendix E, page 258).
5	Message type	String (optional)	This optional field is reserved for future use but may contain the type of message.
6	Version	String (optional)	This optional field is reserved for future use but may contain the version of the message.

Table 5 CSV Metering Point [header] fields

#### 3.3.1.2. Metering Point [data]

The [data] section is composed of one line. Each [data] section in the message identifies the source of the metering data, the direction of the power flow and the access (metering) point to which the data relates. A message can contain 1 or more [data] sections.

Field	Name	Data type	Comment
1	Name of the row	String	Fixed. Always [data]
2	Source identification code	String	EIC company code of the source of the metering data (Elia)
3	Direction of transfer	String	Identification of the direction of flow (see section 1.1.2). Possible values are: <ul style="list-style-type: none"> <li>• PROD: Production of active energy (flow from client to Elia)</li> <li>• CONS: consumption of active energy (flow from client to Elia)</li> </ul>
4	Metering Point identification code	String	EAN (18-digit) code of the Metering Point at which the data is metered.

Table 6 CSV Metering Point message [data] fields

### 3.3.1.3. Metering Point [schedule]

The [schedule] section contains the metering values and their status. A [schedule] is always related to a parent [data] section. Each [data] section can have 1 or more [schedule] sections. The schedules are normally daily schedules, but any time period is theoretically possible.

The [schedule] section contains the metered values for the corresponding [data] section. Each [schedule] section identifies all the parameters used to describe the power as well as the actual power values.

**Note:** *Metering Point metering can contain data other than the power values contained in the regulated metering messages. There are therefore fields that are used in these messages which have no meaning in the context of non-power data.*

*Some fields can therefore be empty.*

Field	Name	Data type	Comment
1	Name of the row	String	Fixed. Always [schedule]
2	Start date and time	Date	Start date and time of the schedule in ISO 8601 format (see section Appendix E, page 258).
3	Duration	Integer	Total number of minutes in the schedule. (! See also section Appendix E, page 258 on the effect of daylight saving.)
4	Period	Integer	Number of minutes for each value period. Always 15.
5	Power type	String (optional)	Identification of the type of power* (see section 1.1.1). Possible values are: <ul style="list-style-type: none"> <li>• A: Active</li> <li>• I: Inductive</li> <li>• C: Capacitive</li> </ul> * this has no meaning for non-power values
6	Metering type	String (optional)	Indication as to whether the values are net or gross* or specific (see section 1.1.3.4). Possible values are <ul style="list-style-type: none"> <li>• N: Net</li> <li>• G: Gross</li> <li>• GG: "Green Gross"</li> <li>• GC: "Gross CIPU"</li> </ul> * this has no meaning for non-power values
7	Compensation type	String (optional)	Indication as to whether the values are compensated or not* (see section 1.1.3.1). Possible values are: <ul style="list-style-type: none"> <li>• NC: Non-Compensated. Used for metering purposes.</li> <li>• C: Compensated. Used for billing purposes</li> <li>• A: Reserved for future use</li> </ul>

			<ul style="list-style-type: none"> <li>• CC: Compensated Corrected Used for specific purposes</li> </ul> <p>* this has no meaning for non-power values</p>
8	Profile type	String	<p>Indication of the load profile*. This field is reserved for possible future use and has no significant meaning. Currently, values could be:</p> <ul style="list-style-type: none"> <li>• ALP: Aggregated load profile</li> <li>• ULP: Undefined load profile</li> </ul> <p>* this has no meaning for non-power values</p>
9	Unit	String (optional)	<p>Unit in which the metered values are defined. This depends on the quantity being measured.</p>
10	Validation	Boolean	<p>Indication as to whether the values are valid or not. Possible values are:</p> <ul style="list-style-type: none"> <li>• True: validated by Elia</li> <li>• False: not validated by Elia</li> </ul>
11 to 203 in steps of 2	Value	signed Decimal	<p>Value of the metered quantity in the unit defined in Field 9 above with a maximum of 3 digits after the decimal point.</p> <ul style="list-style-type: none"> <li>• If the value is negative then the "-" operator is added before the value</li> <li>• If the value is positive then no operator is added</li> </ul>
12 to 204 in steps of 2	Quality	1 char	<p>Indication as to the quality of the metered data (see section 1.1.3.3). Possible values are:</p> <ul style="list-style-type: none"> <li>• N: Normal</li> <li>• I: Inexact</li> <li>• S: Substituted (Estimated replacement).</li> </ul>

Table 7 CSV Metering Point message [schedule] fields

### 3.4. CSV CDS Access Point messages

CDS Access Point messages follow the same structure as Metering Points. See "3.3 CSV Metering Point messages " page 105.



### 3.5. CSV CDS Loop Losses (PBO) messages

CDS Loop Losses (PBO) messages contain metering data about each PBO component (and related criteria's) for a CDS Operator.

The CDS Loop Losses (PBO) message use components. These components are shortly described in section 38.

An example of a CDS Loop Losses (PBO) message containing one component 'CDSTotalInfeedOfftake' is shown below.

```
[header];10X1001A1001A094;22XCDSOPERATOR-4;2015-11-
22T23:00:00Z;CDS PBO;10;Final

[data];CDSTotalInfeedOfftake;IN;541416004540000143

[schedule];2015-07-
31T22:00:00Z;1440;15;A;KW;695939,469;N;542630,839;N;754246,831;N;774000,335;N
;227916,741;N;274833,941;N;456402,326;N;47084,785;N;304156,709;N;417705,989;N
;660633,016;N;138650,68;N;840284,371;N;886871,982;N;382563,901;N;64323,02;N;8
51924,729;N;697956,92;N;437819,982;N;639726,806;N;254702,783;N;666585,803;N;7
42026,258;N;880487,037;N;764243,531;N;708383,632;N;310807,729;N;702228,713;N;
496171,975;N;738975,406;N;859789,395;N;20576,835;N;266113,114;N;673986,125;N;
504596,257;N;551156,402;N;889691,949;N;429040,79;N;60853,314;N;409592,414;N;4
82533,479;N;819764,4;N;344185,567;N;411509,871;N;760262,704;N;861781,955;N;37
0218,015;N;472533,774;N;738504,624;N;470718,455;N;54575,658;N;508289,123;N;33
2884,24;N;462198,901;N;212883,496;N;434400,916;N;359026,551;N;751848,292;N;76
0766,53;N;166494,155;N;732556,558;N;355291,629;N;713849,759;N;520193,839;N;46
9099,259;N;88153,911;N;887758,183;N;511124,969;N;384279,656;N;766060,138;N;29
8116,803;N;54912,543;N;393722,749;N;504635,31;N;660550,618;N;867181,563;N;413
053,536;N;119504,428;N;90684,628;N;163557,029;N;357897,019;N;426292,491;N;304
143,834;N;559663,939;N;143878,198;N;440624,499;N;316553,235;N;171127,295;N;58
6622,071;N;78125,453;N;43537,831;N;713572,097;N;701753,64;N;154420,352;N;3007
22,623;N;302623,343;N;404897,904;N

[schedule];2015-08-
01T22:00:00Z;1440;15;A;KW;585134,196;N;103732,61;N;653906,035;N;511679,864;N;
385891,986;N;268192,792;N;783045,173;N;37724,519;N;372318,721;N;709728,169;N;
605665,755;N;698656,869;N;460039,401;N;443963,742;N;37392,783;N;610101,914;N;
564679,027;N;286524,51;N;793851,256;N;587684,655;N;601862,597;N;153035,474;N;
90666,175;N;547030,091;N;487215,114;N;859121,633;N;543462,539;N;403763,223;N;
136361,575;N;520407,987;N;267865,348;N;73509,049;N;364926,982;N;852519,536;N;
79499,602;N;371892,571;N;188536,334;N;871081,281;N;793990,302;N;314538,789;N;
422814,631;N;491718,221;N;526962,447;N;717072,701;N;83386,874;N;530055,356;N;
94041,038;N;595119,309;N;885878,062;N;1717,687;N;310851,073;N;764303,613;N;45
913,196;N;622330,213;N;193017,554;N;240250,611;N;179117,274;N;507517,934;N;55
6165,481;N;738585,305;N;301115,298;N;472905,85;N;415919,852;N;374932,694;N;32
7532,268;N;434118,962;N;587905,669;N;864917,779;N;173993,182;N;306782,269;N;8
7747,931;N;324165,559;N;656123,042;N;6520,772;N;631071,639;N;468301,034;N;789
546,847;N;348959,47;N;333501,792;N;312949,204;N;489889,598;N;349723,363;N;106
63,39;N;673735,07;N;572776,294;N;824437,451;N;478181,434;N;566283,631;N;53831
,935;N;788726,735;N;751680,923;N;806219,888;N;648681,521;N;158216,214;N;74678
6,857;N;409168,839;N;472950,053;N

...

[end]
```

*Example 75 Fields in a CSV CDS Loop Losses (PBO) message*

#### 3.5.1. Message structure

The CDS Loop Losses (PBO) Message consists of the following sections:

- a [header] section described here below.
- [data] sections described on page 110
- [schedule] sections described on page 110
- [end] – which is the last line indicating the end of the message. All characters following [end] must be ignored.

### 3.5.1.1. CDS Loop Losses (PBO) [header]

The [header] contains information about the parties involved in the message. This is the first line of the file and appears only once.

Field	Name	Data type	Comment
1	Name of the row	String	Fixed. Always [header]
2	Sender identification code	String	EIC code (Energy Identification Code) of the TSO (Elia): 10X1001A1001A094
3	Receiver identification code	String	EIC code (Energy Identification Code) of the receiver of the message
4	Message creation time	Date	Date and time of the file creation in Iso format (see section Appendix E, page 258).
5	Message type	String	Fixed. Always CDSPBO
6	Version	String	The version of the message: An integer within range [1...999]. <b>Note:</b> The first message sent is not guaranteed to have version 1.
7	Message status	String	Indicate if the message is: <ul style="list-style-type: none"> <li>'Intermediate': non-validated</li> <li>'Final' : validated</li> </ul>

Table 8 CSV CDS Loop Losses (PBO) [header] fields

### 3.5.1.2. CDS Loop Losses (PBO) [data]

The [data] section is composed of one line. Each [data] section in the message identifies the Component, the direction of the power flow (see 33). A message contains 1 [data] section for each set of Component and related criteria's.

Field	Name	Data type	Comment
1	Name of the row	String	Fixed. Always [data]
2	Component	String	Name of the component: See "2.5.3.1 CDS Loop Losses (PBO) components " p 38
3	Direction of Power flow	String	Identification of the direction of flow Possible values are: <ul style="list-style-type: none"> <li>OUT: the energy is going out the CDS</li> <li>IN: the energy is coming in the CDS</li> </ul>
4	CDS network identification code	String	EAN (18-digit) code of the CDS for which the PBO is calculated.

Table 9 CSV CDS Loop Losses (PBO)message [data] fields

### 3.5.1.3. PBO [schedule]

The [schedule] section contains the metering values and their status. A [schedule] is always related to a parent [data] section. Each [data] section should have one [schedule] section for each day of the covered month but any time period is theoretically possible.

Field	Name	Data type	Comment
-------	------	-----------	---------

1	Name of the row	String	Fixed. Always [schedule]
2	Start date and time	Date	Start date and time of the schedule in ISO 8601 format (see section Appendix E, page 258).
3	Duration	Integer	Total number of minutes in the schedule. (! See also section Appendix E, page 258 on the effect of daylight saving.)
4	Period	Integer	Number of minutes for each value period. Always 15.
5	Power type	String	Identification of the type of power* (see section 1.1.1). Possible values are: <ul style="list-style-type: none"> <li>• A: Active</li> <li>• I: Inductive</li> <li>• C: Capacitive</li> </ul> * Normally only Active power type are part of the CDS Loop Losses (PBO) message but theoretically other power type could also exist
9	Unit	String	Unit in which the metered values are defined. Normally always KW
10 to 202 in steps of 2	Value	Signed Decimal	Value of the metered quantity in the unit defined in Field 9 above with a maximum of 3 digits after the decimal point. <ul style="list-style-type: none"> <li>• If the value is positive then no "+" sign is added</li> <li>• If the value is negative then "-" sign is added</li> </ul>
11 to 203 in steps of 2	Quality	1 char	Indication as to the quality of the metered data (see section 1.1.3.3). Possible values are: <ul style="list-style-type: none"> <li>• N: Normal</li> <li>• I: Inexact</li> <li>• S: Substituted (Estimated replacement).</li> </ul>

Table 10 CSV PBO message [schedule] fields



3	Receiver identification code	String	EAN (13-digit) company code of the receiver of the message i.e. the DGO or MRCO.
4	Message creation time	Date	Date and time of the file creation in Iso 8601 format (see section "4.17 Data types "page195)
5	Message type	String (optional)	This optional field is reserved for future use but may contain the type of message.
6	Version	String (optional)	This optional field is reserved for future use but may contain the version of the message.

Table 11 CSV Infeed TSO per substation &lt;header&gt; fields

### 3.6.1.2. <data>

The <data> section is composed of one line. It identifies the source of the metering data, the distribution border point, the number of Access Points related to the distribution point, and the direction of the power flow. Each DGO that uses a distribution point has a specific Access Point – see Figure 10 on page 43.

There can be several <data> sections within one message. A <data> section is always followed by a <schedule> section.

Field	Name	Data type	Comment
1	Name of the row	String	Fixed. Always <data>
2	Source identification code	String	EAN (13-digit) company code of the source of the metering data (Elia)
3	Direction of transfer	String	Identification of the direction of flow (see section 1.1.2). Possible values are: <ul style="list-style-type: none"> <li>• PROD: Production of active energy (flow from client to Elia)</li> <li>• CONS: consumption of active energy (flow from Elia to client)</li> </ul>
4	DGOB identification code	String	EAN (18-digit) code of the Distribution Point associated with the substation. See section 0.
5	Number of associated Access Points	Integer	Number of Access Points associated with the border point and for which data is included in the message (see Figure 10 on page 43).
6	Associated Access Point identification code	String	EAN (18-digit) codes of the Access Points, the number of which is indicated in field number 5 above.

Table 12 CSV Infeed TSO per substation &lt;data&gt; fields

### 3.6.1.3. <schedule>

The <schedule> section contains the metering values and their status. A <schedule> is always related to a parent <data> section. Each <data> section can have 1 or more <schedule> sections. The schedules are normally daily schedules, but any time period is theoretically possible.

Field	Name	Data type	Comment
1	Name of the row	String	Fixed. Always <schedule>
2	Start date and time	Date	Start date and time of the schedule in ISO 8601 format (see section Appendix E, page 258).
3	Duration	Integer	Total number of minutes in the schedule. (! See also section Appendix E, page 258 on the effect of daylight saving.)
4	Period	Integer	Number of minutes for each value period. Always 15.
5	Power type	String	Identification of the type of power (see section 1.1.1). Possible values are: <ul style="list-style-type: none"> <li>• A: Active</li> <li>• I: Inductive</li> <li>• C: Capacitive</li> </ul>
6	Profile type	String	Indication of the load profile. This field is reserved for possible future use and has no significant meaning. Currently, values could be: <ul style="list-style-type: none"> <li>• ALP: Aggregated load profile</li> <li>• ULP: Undefined load profile</li> </ul>
7	Power unit	String	Unit in which the power values are defined. Possible values are: <ul style="list-style-type: none"> <li>• KWT, KVR,</li> <li>• W, KW, MW,</li> <li>• VAR, KVAR, MVAR</li> </ul>
8	Validation	Boolean	Indication as to whether the values are valid or not (see section 1.2.3). Possible values are: <ul style="list-style-type: none"> <li>• True: validated by Elia</li> <li>• False: not validated by Elia</li> </ul>
From 9 to the end in steps of 2	Value	Unsigned Decimal	Value of the transferred power. The value is always positive. The value is expressed in the defined unit and contains a maximum of 3 digits after the decimal point.
From 9 to the end in steps of 2	Quality	1 char	Indication as to the quality of the metered data (see section 1.1.3.3). Possible values are: <ul style="list-style-type: none"> <li>• N: Normal</li> <li>• I: Inexact</li> <li>• S: Substituted (Estimated replacement).</li> </ul>

Table 13 CSV Infeed TSO per substation &lt;schedule&gt; fields

### 3.7. CSV Infeed TSO per substation and per supply bay messages

This type of message is delivered to Distribution Grid Operators (DGO) and Meter Reading Companies (MRCO). These messages provide metering values for all the power transferred from Elia across a DGO supply bay within a substation. Infeed TSO per substation and per supply bay messages are “regulated” messages. For a general explanation of the content of these messages see section 2.7.

An example of a message for 1 supply bay for a single power type (A = Active, N=net, NC = Non-Compensated) is shown below.

Note that the presentation of this example illustrates the overall structure of the message rather than the complete contents. Only the first of the power values are shown in each of the [schedule] sections.

```
<header>;5499770302608;549912345678;2004-06-10T08:18:34+02:00
<data>;5499770302608;CONS;541453110145211219
<schedule>;2005-06-06T22:00:00Z;1440;15;A;N;NC;ULP;W;False; 0;N; 0;N;
69815.283;N; 69822.276;N; 70414.745;N; 72648.07;N; 70612.372;N; 70813.118;N;
70353.604;N; 70919.58;N; 70980.202;N; 70585.069;N; 70750.728;N; 70958.432;N;
70776.714;N; 70545.643;N; 71100.622;N; 72332.169;N; 71764.899;N; 70709.063;N;
70696.182;N; 70826.037;N; 70635.557;N; 70591.541;N; 70474.789;N; 70828.492;N;
70621.441;N; 70479.102;N; 70633.711;N; 71908.358;N; 71956.669;N; 70695.815;N;
70613.909;N; 70737.232;N; 71454.805;N; 69888.043;N; 70074.782;N; 69324.786;N;
70842.82;N; 71021.133;N; 70678.198;N; 70627.358;N; 71339.325;N; 71856.235;N;
70556.298;N; 70934.224;N; 71104.177;N; 71003.121;N; 70745.411;S; 71149.1;N;
70714.625;N; 70555.06;N; 70575.312;N; 71773.064;N; 72108.967;N; 70849.043;N;
70963.407;N; 70666.142;N; 70749.688;N; 70776.87;N; 70678.946;N; 71291.748;N;
70793.857;N; 70887.839;N; 70681.146;N; 70760.146;N; 70729.713;N; 70804.071;N;
70291.859;N; 69827.026;N; 70384.598;N; 70666.833;N; 70785.496;N; 70202.614;N;
70528.963;N; 71262.107;N; 70829.412;N; 70860.176;N; 70963.875;N; 71144.164;N;
71032.454;N; 70957.065;N; 70815.127;N; 71160.487;N; 71253.751;N; 69908.861;N;
65921.615;N; 64128.27;N; 63491.778;N; 63507.779;N; 64952.333;N; 63870.739;N;
62801.054;N; 63109.382;N; 63421.165;N; 65832.926;N
<end>
```

*Example 77 Fields in a CSV Infeed TSO per substation and per supply bay message*

#### 3.7.1. Message structure

The Infeed TSO per substation and per supply bay message consists of the following sections:

- <header> section described on page 115.
- <data> sections described on page 116.
- <schedule> sections described on page 116.
- <end> section, which is the last line indicating the end of the message. All characters following <end> must be ignored.

##### 3.7.1.1. <header>

The <header> contains information about the parties involved in the message. This is the first line of the file and appears only once.

Its syntax is the same as the header of the Infeed TSO per substation described on page 112.

Field	Name	Data type	Comment
1	Name of the row	String	Fixed. Always <header>
2	Sender identification code	String	EAN (13-digit) company code of the sender of the message i.e. Elia

3	Receiver identification code	String	EAN (13-digit) company code of the receiver of the message i.e. the DGO or MRCO.
4	Message creation time	Date	Date and time of the file creation in Iso format (see section Appendix E, page 258).
5	Message type	String (optional)	This optional field is reserved for future use but may contain the type of message.
6	Version	String (optional)	This optional field is reserved for future use but may contain the version of the message.

Table 14 CSV Infeed TSO per substation and per supply bay <header> fields

### 3.7.1.2. <data>

The <data> section is composed of one line. It identifies the source of the metering data, the supply bay at which the data is metered and the energy direction. A message can contain 1 or more <data> sections. Each <data> section can have 1 or more <schedule> sections.

Field	Name	Data type	Comment
1	Name of the row	String	Fixed. Always <data>
2	Source identification code	String	EAN (13-digit) company code of the source of the metering data (Elia)
3	Direction of transfer	String	Identification of the direction of flow (see section 1.1.2). Possible values are: <ul style="list-style-type: none"> <li>• PROD: Production of active energy (flow from DGO to Elia)</li> <li>• CONS: consumption of active energy (flow from Elia to DGO)</li> </ul>
4	supply bay identification code	String	EAN (18-digit) code of the supply bay at which the data is metered.

Table 15 CSV Infeed TSO per substation and per supply bay <data> fields

### 3.7.1.3. <schedule>

The <schedule> section contains the metering values and their quality. A <schedule> is always related to a parent <data> section. Each <data> section can have 1 or more <schedule> sections. The schedules are normally daily schedules, but any time period is theoretically possible.

Only positive power values are allowed in the message.

Field	Name	Data type	Comment
1	Name of the row	String	Fixed. Always <schedule>
2	Start date and time	Date	Start date and time of the schedule in ISO 8601 format (see section Appendix E, page 258).
3	Duration	Integer	Total number of minutes in the schedule. (! See also section Appendix E, page 258 on the effect of daylight saving).



4	Period	Integer	Number of minutes for each value period. Always 15.
5	Power type	String	Identification of the type of power (see section 1.1.1). Possible values are: <ul style="list-style-type: none"> <li>• A: Active</li> <li>• I: Inductive</li> <li>• C: Capacitive</li> </ul>
6	Metering type	String	Indication as to whether the values are net, gross or specific (see section 1.1.3.4). Possible values are: <ul style="list-style-type: none"> <li>• N: Net</li> <li>• G: Gross</li> <li>• GG: "Green Gross"</li> <li>• GC: "Gross CIPU"</li> </ul>
7	Compensation type	String	Indication as to whether the values compensated or not (see section 1.1.3.1). Possible values: <ul style="list-style-type: none"> <li>• NC: Non-Compensated. Used for metering purposes.</li> <li>• C: Compensated. Used for billing purposes</li> <li>• A: Reserved for future use</li> <li>• CC: Compensated Corrected Used for specific purposes</li> </ul>
8	Profile type	String	Indication of the load profile. This field is reserved for possible future use and has no significant meaning. Possible value: ULP: Undefined load profile
9	Power unit	String	Unit in which the power values are defined. Possible values are: <ul style="list-style-type: none"> <li>• KWT, KVR,</li> <li>• W, KW, MW,</li> <li>• VAR, KVAR, MVAR</li> </ul>
10	Validation	Boolean	Indication as to whether the values are valid or not (see section 1.2.3). Possible values are: <ul style="list-style-type: none"> <li>• True: validated by Elia</li> <li>• False: not validated by Elia</li> </ul>
11 to 203 in steps of 2	Value	Unsigned Decimal	Value of the transferred power. The value is always positive. The value is expressed in the defined unit and contains a maximum of 3 digits after the decimal point.
12 to 204 in steps of 2	Quality	1 char	Indication as to the quality of the metered data (see section 1.1.3.3). Possible values are: <ul style="list-style-type: none"> <li>• N: Normal</li> </ul>

			<ul style="list-style-type: none"> <li>• I: Inexact</li> <li>• S: Substituted (Estimated replacement).</li> </ul>
--	--	--	---

Table 16 CSV Infeed TSO per substation and per supply bay <schedule> fields

### 3.8. CSV GEMP messages

A GEMP is a Global Elia Metered Position. This type of message provides aggregated metering data to Access Responsible Parties (BRPs). The metered data values are summed over the whole of Belgium, over regions for which a regulator is defined, and over the regions with respect to a supplier. These are regulated messages. For a general explanation of the content of these messages see section 2.8.

An example of a message GEMP is shown below. It relates to one BRP who is responsible for Access Points (production and consumption) Inductive, Active and Capacitive in Brussels, Flanders, Wallonia and Federal. This same BRP is responsible for Suppliers Sup1, Sup2 in various regions.

Note that the presentation of this example illustrates the overall structure of the message rather than the complete contents. Only the first of the power values is shown in each of the [schedule] sections.

```
[header];10X1001A1001A094;22XBRPA-----A;2005-03-09T08:32:22+01:00;GEMP ARP

[dataG];10X1001A1001A094;PROD
[schedule];2005-03-07T23:00:00Z;1440;15;A;N;C;ULP;W;False; 7691945.476;I;
{...}
[schedule];2005-03-07T23:00:00Z;1440;15;C;N;C;ULP;VAR;False; 0;N; 0;N; {...}
[schedule];2005-03-07T23:00:00Z;1440;15;I;N;C;ULP;VAR;False; 0;N; 0;N; {...}
[dataG];10X1001A1001A094;CONS
[schedule];2005-03-07T23:00:00Z;1440;15;A;N;C;ULP;W;False;
2076676.348;I; {...}
[schedule];2005-03-07T23:00:00Z;1440;15;C;N;C;ULP;VAR;False; 45823;N; {...}
[schedule];2005-03-07T23:00:00Z;1440;15;I;N;C;ULP;VAR;False; 392639.882;N;
{...}
[dataR];10X1001A1001A094;PROD;BRU
[schedule];2005-03-07T23:00:00Z;1440;15;A;N;C;ULP;W;False; 33790.2;N; {...}
[dataR];10X1001A1001A094;PROD;FED
[schedule];2005-03-07T23:00:00Z;1440;15;A;N;NC;ULP;W;False; 5872290.968;N;
{...}
[schedule];2005-03-07T23:00:00Z;1440;15;C;N;C;ULP;VAR;False; 0;N; {...}
[schedule];2005-03-07T23:00:00Z;1440;15;I;N;C;ULP;VAR;False; 0;N; 0;N; {...}
[dataR];10X1001A1001A094;PROD;FLE
[schedule];2005-03-07T23:00:00Z;1440;15;A;N;C;ULP;W;False; 103065.507;I;
{...}
[dataR];10X1001A1001A094;PROD;WAL
[schedule];2005-03-07T23:00:00Z;1440;15;A;N;C;ULP;W;False; 10677.34;N; {...}
[dataR];10X1001A1001A094;CONS;BRU
[schedule];2005-03-07T23:00:00Z;1440;15;A;N;C;ULP;W;False; 38770.631;N; {...}
[schedule];2005-03-07T23:00:00Z;1440;15;C;N;C;ULP;VAR;False; 380;N; {...}
[schedule];2005-03-07T23:00:00Z;1440;15;I;N;C;ULP;VAR;False; 5500;N; {...}
[schedule];2005-03-07T23:00:00Z;1440;15;C;N;NC;ULP;VAR;False; 380;N; {...}
[schedule];2005-03-07T23:00:00Z;1440;15;I;N;NC;ULP;VAR;False; 0;N; {...}
[dataR];10X1001A1001A094;CONS;FLE
[schedule];2005-03-07T23:00:00Z;1440;15;A;N;C;ULP;W;False; 453370.198;I; {...}
[dataR];10X1001A1001A094;CONS;FED
[schedule];2005-03-07T23:00:00Z;1440;15;A;N;C;ULP;W;False; 1375467.584;N;
{...}
[schedule];2005-03-07T23:00:00Z;1440;15;C;N;NC;ULP;VAR;False; 51341;N; {...}
[dataR];10X1001A1001A094;CONS;WAL
[schedule];2005-03-07T23:00:00Z;1440;15;A;N;C;ULP;W;False; 209067.935;N;
{...}
[schedule];2005-03-07T23:00:00Z;1440;15;C;N;NC;ULP;VAR;False; 2848;N; {...}
[schedule];2005-03-07T23:00:00Z;1440;15;I;N;NC;ULP;VAR;False; 25860;N; {...}
[dataS];10X1001A1001A094;PROD;BRU; 11XSUP1-----Z
[schedule];2005-03-07T23:00:00Z;1440;15;A;N;C;ULP;W;False; 33790.2;N; {...}
[dataS];10X1001A1001A094;PROD;FED; 11XSUP1-----Z
[schedule];2005-03-11T23:00:00Z;1440;15;A;N;C;ULP;W;False; 6518543.995;N;
```

```

{...}
[dataS];10X1001A1001A094;PROD;FLE; 11XSUP1-----Z
[schedule];2005-03-11T23:00:00Z;1440;15;A;N;NC;ULP;W;False; 30882.102;N;
{...}
[dataS];10X1001A1001A094;PROD;WAL; 11XSUP1-----Z
[schedule];2005-03-11T23:00:00Z;1440;15;A;N;C;ULP;W;False; 10558.59;N; {...}
[dataS];10X1001A1001A094;PROD;BRU; 11XSUP1-----Z
[schedule];2005-03-11T23:00:00Z;1440;15;A;N;NC;ULP;W;False; 32795.2;N; {...}
[schedule];2005-03-11T23:00:00Z;1440;15;A;N;C;ULP;W;False; 32795.2;N; {...}
[dataS];10X1001A1001A094;CONS;BRU; 11XSUP1-----Z
[schedule];2005-03-11T23:00:00Z;1440;15;A;N;C;ULP;W;False; 29699.088;N; {...}
[dataS];10X1001A1001A094;CONS;FLE; 11XSUP1-----Z
[schedule];2005-03-11T23:00:00Z;1440;15;A;N;C;ULP;W;False; 416113.492;I; {...}
[schedule];2005-03-11T23:00:00Z;1440;15;A;N;NC;ULP;W;False; 20968.384;N;
{...}
[dataS];10X1001A1001A094;CONS;FED; 11XSUP1-----Z
[schedule];2005-03-11T23:00:00Z;1440;15;A;N;C;ULP;W;False; 1428281.663;N;
{...}
[dataS];10X1001A1001A094;CONS;WAL; 11XSUP1-----Z
[schedule];2005-03-11T23:00:00Z;1440;15;A;N;C;ULP;W;False; 157461.186;N;
{...}
[schedule];2005-03-11T23:00:00Z;1440;15;A;N;NC;ULP;W;False; 25;N; 0;N; {...}
[dataS];10X1001A1001A094;CONS;WAL; 11XSUP2-----Z
[schedule];2005-03-11T23:00:00Z;1440;15;A;N;C;ULP;W;False; 700.3;N; {...}
[end]

```

Example 78 Fields in a CSV GEMP message

### 3.8.1. Message structure

The GEMP consists of the following sections:

- [header] section described on page 106.
- [dataG], [dataR], [dataS] sections described on page 120.
- [schedule] sections described on page 121.
- [end] – which is the last line indicating the end of the message. All characters following [end] must be ignored.

#### 3.8.1.1. [header]

The [header] contains information about the parties involved in the message. This is the first line of the file and appears only once.

Field	Name	Data type	Comment
1	Name of the row	String	Fixed. Always [header]
2	Sender identification code	String	EIC code (Energy Identification Code) of the sender of the message (Elia).
3	Receiver identification code	String	EIC code of the receiver of the message of the message.
4	Message creation time	Date	Date and time of the file creation in ISO 8601 format
5	Message type	String	Fixed. Always "GEMP ARP"
6	Version	String (optional)	This optional field is reserved for future use but may contain the version of the message.

Table 17 CSV GEMP [header] fields

### 3.8.1.2. [data]

There are three data sections in the message that correspond to the three summations: [dataG] which refers to the national (global) aggregated data, [dataR] which refers to the data per region and [dataS] which refers to data per region per supplier.

#### 3.8.1.2.1. [dataG]

[dataG] contains the national (global) summation for all Access Points in Belgium that are in the scope of responsibility of the BRP. Each [dataG] section in the message identifies the source of the metering data and the direction of the power flow.

Field	Name	Data type	Comment
1	Name of the row	String	Fixed. Always [dataG]
2	Source identification code	String	EIC code of the source of the metering data (Elia)
3	Direction of transfer	String	Identification of the direction of flow (see section 1.1.2). Possible values are: <ul style="list-style-type: none"> <li>• PROD: Production of active energy (flow from client to Elia)</li> <li>• CONS: Consumption of active energy (flow from client to Elia)</li> </ul>

Table 18 CSV GEMP [dataG] fields

#### 3.8.1.2.2. [dataR]

[dataR] contains the sum of metering data for all Access Points that are in the scope of responsibility of the BRP in each regulated region. Each [dataR] section in the message identifies the source of the metering data, the direction of the power flow and the region.

Field	Name	Data type	Comment
1	Name of the row	String	Fixed. Always [dataR]
2	Source identification code	String	EIC code of the source of the metering data (Elia).
3	Direction of transfer	String	Identification of the direction of flow (see section 1.1.2). Possible values are: <ul style="list-style-type: none"> <li>• PROD: Production of active energy (flow from client to Elia)</li> <li>• CONS: Consumption of active energy (flow from client to Elia)</li> </ul>
4	Region	string	Field indicating the region over which the values are summed. Possible values are: <ul style="list-style-type: none"> <li>• FLE: Flemish region</li> <li>• WAL: Wallonia region</li> <li>• BRU: Brussels region</li> </ul>

			<ul style="list-style-type: none"> <li>FED: Federal region. This region contains all Access Points that are on the 380/220/150 kV network (independently of the physical location).</li> </ul>
--	--	--	--

Table 19 CSV GEMP [dataR] fields

### 3.8.1.2.3. [dataS]

[dataS] – contains the sum of metering data for all Access Points that are in the scope of responsibility of the BRP in each regulated region and for each supplier. Each [dataS] section in the message identifies the source of the metering data, the direction of the power flow, the region and the energy supplier.

The [dataS] section is only contained in messages delivered to BRPs.

Field	Name	Data type	Comment
1	Name of the row	String	Fixed. Always [dataS]
2	Source identification code	String	EIC code of the source of the metering data (Elia)
3	Direction of transfer	String	Identification of the direction of flow (see section 1.1.2). Possible values are: <ul style="list-style-type: none"> <li>PROD: Production of active energy (flow from client to Elia).</li> <li>CONS: Consumption of active energy (flow from client to Elia).</li> </ul>
4	Region	string	Field indicating the region over which the values are summed. Possible values are: <ul style="list-style-type: none"> <li>FLE: Flemish region</li> <li>WAL: Wallonia region</li> <li>BRU: Brussels region</li> <li>FED: Federal region. This region contains all Access Points that are on the 380/220/150 kV grid (independently of the physical location).</li> </ul>
6	Supplier identification code	String	EIC code of the supplier for which the values are summed.

Table 20 CSV GEMP [dataS] fields

### 3.8.1.3. [schedule]

The schedule section is linked with the [dataG], [dataR] or [dataS] section that precedes it. There can be several schedule lines for each type of data section.

The schedules are normally daily schedules, but any time period is in theory possible.

Field	Name	Data type	Comment
1	Name of the row	String	Fixed. Always [schedule]
2	Start date and time	Date	Start date and time of the schedule in ISO 8601 format (see section Appendix E, page 258).

3	Duration	Integer	Total number of minutes in the schedule (! See also section Appendix E, page 258 on the effect of daylight saving.)
4	Period	Integer	Number of minutes for each value period. Always 15.
5	Power type	String	<p>Identification of the type of power (see section 1.1.1). Possible values are:</p> <ul style="list-style-type: none"> <li>• A: Active</li> <li>• I: Inductive</li> <li>• C: Capacitive</li> <li>• Only Active values are provided to BRPs.</li> </ul>
6	Metering type	String	<p>Indication as to whether the values are net, gross or specific (see section 1.1.3.4). Possible values:</p> <ul style="list-style-type: none"> <li>• N: Net</li> <li>• G: Gross</li> <li>• GG: "Green Gross"</li> <li>• GC: "Gross CIPU"</li> </ul>
7	Compensation type	String	<p>Indication as to whether the values compensated or not (see section 1.1.3.1). Possible values:</p> <ul style="list-style-type: none"> <li>• NC: Non-Compensated. Used for metering purposes.</li> <li>• C: Compensated. Used for billing purposes</li> <li>• A: Reserved for future use</li> <li>• CC: Compensated Corrected. Used for specific purposes</li> </ul>
8	Profile type	string	<p>Indication of the load profile. This field is reserved for possible future use and has no significant meaning. Currently, values could be:</p> <ul style="list-style-type: none"> <li>• ALP: Aggregated load profile,</li> <li>• ULP: Undefined load profile</li> </ul>
9	Power unit	String	<p>Unit in which the power values are defined. Possible values are:</p> <ul style="list-style-type: none"> <li>• KWT, KVR,</li> <li>• W, KW, MW,</li> <li>• VAR, KVAR, MVAR</li> </ul>
10	Validation	Boolean	<p>Indication as to whether the values are valid or not (see section 1.2.3). Possible values are:</p> <ul style="list-style-type: none"> <li>• True: validated by Elia</li> <li>• False: not validated by Elia</li> </ul>
11 to 203 in steps of 2	Value	Unsigned Decimal	Value of the transferred power. The value is always positive. The value is expressed in the defined unit and contains a maximum of 3 digits after the decimal point.
12 to 204 in steps of 2	Quality	1 char	<p>Indication as to the quality of the metered data (see section 1.1.3.3). Possible values are:</p> <ul style="list-style-type: none"> <li>• N: Normal</li> </ul>

			<ul style="list-style-type: none"> <li>• I: Inexact</li> <li>• S: Substituted (Estimated replacement).</li> </ul>
--	--	--	---

Table 21 CSV GEMP [schedule] fields

### 3.9. CSV Imbalance messages

Imbalance metering messages contain metering data about each Imbalance component (and related criteria's) for a BRP. See section "2.9 Imbalance "page56

These components are shortly described in section "2.9.3.1 Imbalance components "page 57.

An example of an Imbalance message containing one component 'CrossBorderExportTotal' is shown below.

```
[header];10X1001A1001A094;22XBRPA-----A;2015-09-
17T22:00:00Z;IMBALANCE;10;Final

[data];CrossBorderExportTotal;22XBRPA-----A;OUT

[schedule];2015-07-
31T22:00:00Z;1440;15;A;N;C;ALP;KW;695939,469;N;542630,839;N;754246,831;N;7740
00,335;N;227916,741;N;274833,941;N;456402,326;N;47084,785;N;304156,709;N;4177
05,989;N;660633,016;N;138650,68;N;840284,371;N;886871,982;N;382563,901;N;6432
3,02;N;851924,729;N;697956,92;N;437819,982;N;639726,806;N;254702,783;N;666585
,803;N;742026,258;N;880487,037;N;764243,531;N;708383,632;N;310807,729;N;70222
8,713;N;496171,975;N;738975,406;N;859789,395;N;20576,835;N;266113,114;N;67398
6,125;N;504596,257;N;551156,402;N;889691,949;N;429040,79;N;60853,314;N;409592
,414;N;482533,479;N;819764,4;N;344185,567;N;411509,871;N;760262,704;N;861781,
955;N;370218,015;N;472533,774;N;738504,624;N;470718,455;N;54575,658;N;508289,
123;N;332884,24;N;462198,901;N;212883,496;N;434400,916;N;359026,551;N;751848,
292;N;760766,53;N;166494,155;N;732556,558;N;355291,629;N;713849,759;N;520193,
839;N;469099,259;N;88153,911;N;887758,183;N;511124,969;N;384279,656;N;766060,
138;N;298116,803;N;54912,543;N;393722,749;N;504635,31;N;660550,618;N;867181,5
63;N;413053,536;N;119504,428;N;90684,628;N;163557,029;N;357897,019;N;426292,4
91;N;304143,834;N;559663,939;N;143878,198;N;440624,499;N;316553,235;N;171127,
295;N;586622,071;N;78125,453;N;43537,831;N;713572,097;N;701753,64;N;154420,35
2;N;300722,623;N;302623,343;N;404897,904;N

[schedule];2015-08-
01T22:00:00Z;1440;15;A;N;C;ALP;KW;585134,196;N;103732,61;N;653906,035;N;51167
9,864;N;385891,986;N;268192,792;N;783045,173;N;37724,519;N;372318,721;N;70972
8,169;N;605665,755;N;698656,869;N;460039,401;N;443963,742;N;37392,783;N;61010
1,914;N;564679,027;N;286524,51;N;793851,256;N;587684,655;N;601862,597;N;15303
5,474;N;90666,175;N;547030,091;N;487215,114;N;859121,633;N;543462,539;N;40376
3,223;N;136361,575;N;520407,987;N;267865,348;N;73509,049;N;364926,982;N;85251
9,536;N;79499,602;N;371892,571;N;188536,334;N;871081,281;N;793990,302;N;31453
8,789;N;422814,631;N;491718,221;N;526962,447;N;717072,701;N;83386,874;N;53005
5,356;N;94041,038;N;595119,309;N;885878,062;N;1717,687;N;310851,073;N;764303,
613;N;45913,196;N;622330,213;N;193017,554;N;240250,611;N;179117,274;N;507517,
934;N;556165,481;N;738585,305;N;301115,298;N;472905,85;N;415919,852;N;374932,
694;N;327532,268;N;434118,962;N;587905,669;N;864917,779;N;173993,182;N;306782
,269;N;87747,931;N;324165,559;N;656123,042;N;6520,772;N;631071,639;N;468301,0
34;N;789546,847;N;348959,47;N;333501,792;N;312949,204;N;489889,598;N;349723,3
63;N;10663,39;N;673735,07;N;572776,294;N;824437,451;N;478181,434;N;566283,631
;N;53831,935;N;788726,735;N;751680,923;N;806219,888;N;648681,521;N;158216,214
;N;746786,857;N;409168,839;N;472950,053;N

[end]
```

Example 79 Fields in a CSV Imbalance message

#### 3.9.1. Message structure

The Imbalance Message consists of the following sections:

- a [header] section described here below.
- [data] sections described on page 125
- [schedule] sections described on page 107.

- [end] – which is the last line indicating the end of the message. All characters following [end] must be ignored.

### 3.9.1.1. Imbalance [header]

The [header] contains information about the parties involved in the message. This is the first line of the file and appears only once.

Field	Name	Data type	Comment
1	Name of the row	String	Fixed. Always [header]
2	Sender identification code	String	EIC code (Energy Identification Code) of the TSO (Elia): 10X1001A1001A094
3	Receiver identification code	String	EIC code (Energy Identification Code) of the receiver of the message
4	Message creation time	Date	Date and time of the file creation in Iso format (see section Appendix E, page 258).
5	Message type	String	Fixed. Always IMBALANCE
6	Version	String	The version of the message: An integer within range [1...999]. <b>Note:</b> The first message sent is not guaranteed to have version 1.
7	Message status	String	Indicate if the message is 'Intermediate', 'Final' or 'FinalModified'

Table 22 CSV Imbalance [header] fields

### 3.9.1.2. Imbalance [data]

The [data] section is composed of one line. Each [data] section in the message identifies the Component, the direction of the power flow (see "2.9.3.2 Imbalance components "page 61), and the party or the Area the component to which the data relates (see "Imbalance components added parameters Imbalance components added parameters" page 63). A message contains 1 [data] section for each set of Component and related criteria's.

Field	Name	Data type	Comment
1	Name of the row	String	Fixed. Always [data]
2	Component	String	Name of the component: See "2.9.3.1 Imbalance components "page 57
3	Party/Area	String	The party or Area related to the component: see "2.9.3.3 Imbalance components added parameters " p 63
3	Direction of Power flow	String	Identification of the direction of flow (see section see "2.9.3.2 Imbalance components "page61). Possible values are: <ul style="list-style-type: none"> <li>• OUT: the energy is going out the BRP Balance perimeter</li> <li>• IN: the energy is coming in the BRP balance perimeter</li> </ul>

Table 23 CSV Imbalance message [data] fields



### 3.9.1.3. Imbalance [schedule]

The [schedule] section contains the metering values and their status. A [schedule] is always related to a parent [data] section. Each [data] section should have one [schedule] section for each day of the covered month but any time period is theoretically possible.

Field	Name	Data type	Comment
1	Name of the row	String	Fixed. Always [schedule]
2	Start date and time	Date	Start date and time of the schedule in ISO 8601 format (see section Appendix E, page 258).
3	Duration	Integer	Total number of minutes in the schedule. (! See also section Appendix E, page 258 on the effect of daylight saving.)
4	Period	Integer	Number of minutes for each value period. Always 15.
5	Power type	String	<p>Identification of the type of power* (see section 1.1.1). Possible values are:</p> <ul style="list-style-type: none"> <li>• A: Active</li> <li>• I: Inductive</li> <li>• C: Capacitive</li> </ul> <p>* Normally only Active power type are part of the Imbalance message but theoretically other power type could also exist</p>
6	Metering type	String	<p>Indication as to whether the values are net or gross* or specific (see section 1.1.3.4). Possible values are</p> <ul style="list-style-type: none"> <li>• N: Net</li> <li>• G: Gross</li> <li>• GG: "Green Gross"</li> <li>• GC: "Gross CIPU"</li> </ul> <p>* Normally only Net metering type are part of the Imbalance message but theoretically other metering type could also exist</p>
7	Compensation type	String	<p>Indication as to whether the values are compensated or not* (see section 1.1.3.1). Possible values are:</p> <ul style="list-style-type: none"> <li>• NC: Non-Compensated. Used for metering purposes.</li> <li>• C: Compensated. Used for billing purposes</li> <li>• A: Reserved for future use</li> <li>• CC: Compensated Corrected Used for specific purposes</li> </ul> <p>* Normally only Compensated are part of the Imbalance message but theoretically other Compensation type could also exist</p>

8	Profile type	String	<p>Indication of the load profile*. This field is reserved for possible future use and has no significant meaning. Currently, values could be:</p> <ul style="list-style-type: none"> <li>• ALP: Aggregated load profile</li> <li>• ULP: Undefined load profile</li> </ul> <p>* Normally only ALP are part of the Imbalance message but theoretically ULP type could also exist</p>
9	Unit	String	<p>Unit in which the metered values are defined.</p> <p>Normally always KW</p>
10 to 202 in steps of 2	Value	Signed Decimal	<p>Value of the metered quantity in the unit defined in Field 9 above with a maximum of 3 digits after the decimal point.</p> <ul style="list-style-type: none"> <li>• If the value is positive then no "+" sign is added</li> <li>• If the value is negative then "-" sign is added</li> </ul>
11 to 203 in steps of 2	Quality	1 char	<p>Indication as to the quality of the metered data (see section 1.1.3.3). Possible values are:</p> <ul style="list-style-type: none"> <li>• N: Normal</li> <li>• I: Inexact</li> <li>• S: Substituted (Estimated replacement).</li> </ul>

Table 24 CSV Imbalance message [schedule] fields

### 3.10. CSV Transfer of Energy (ToE) Delivered volumes messages

Transfer of Energy (ToE) delivered volumes metering messages contain metering data about each Transfer of Energy (ToE) delivered volumes component (and related criteria's) for a BSP/FSP.

These components are shortly described in section "2.10.3.1 Transfer of Energy (ToE) delivered volumes Components " p 70.

An example of an Transfer of Energy (ToE) Delivered volumes message containing one component 'ToEVolumesDownInjection\_DeliveredVolumeperDeliveryPoint\_PerDelivery&MeteringDirection' is shown below.

```
[header];10X1001A1001A094;22X2example----4;2021-08-11T15:02:36Z;DPBSP;3;Final;10YBE-----2

[data];ToEVolumesDownInjection_DeliveredVolumeperDeliveryPoint_PerDelivery&MeteringDirection;541449200000555507;IN

[schedule];2021-04-29T22:00:00Z;1440;15;A;N;C;ULP;KW;695939;N;469[end]
```

Example 80 Fields in a CSV Transfer of Energy (ToE) Delivered volumes message

#### 3.10.1. Message structure

The Imbalance Message consists of the following sections:

- a [header] section described here below.
- [data] sections described on page 127

- [schedule] sections described on page 127 .
- [end] – which is the last line indicating the end of the message. All characters following [end] must be ignored.

### 3.10.1.1. Transfer of Energy (ToE) delivered volumes [header]

The [header] contains information about the parties involved in the message. This is the first line of the file and appears only once.

Field	Name	Data type	Comment
1	Name of the row	String	Fixed. Always [header]
2	Sender identification code	String	EIC code (Energy Identification Code) of the TSO (Elia): 10X1001A1001A094
3	Receiver identification code	String	EIC code (Energy Identification Code) of the BSP/FSP receiver of the message
4	Message creation time	Date	Date and time of the file creation in Iso format (see section Appendix E, page 258).
5	Message type	String	Fixed. Always DPBSP
6	Version	String	The version of the message: An integer within range [1...999]. <b>Note:</b> The first message sent is not guaranteed to have version 1.
7	Message status	String	Indicate if the message is 'Intermediate', 'Final' or 'FinalModified'

Table 25 CSV Transfer of Energy (ToE) Delivered volumes [header] fields

### 3.10.1.2. Transfer of Energy (ToE) delivered volumes [data]

The [data] section is composed of one line. Each [data] section in the message identifies the Component , the direction of the power flow (see "2.9.3.2 Imbalance components "page 61 ), and the party or the Area the component to which the data relates (see "Imbalance components added parameters Imbalance components added parameters" page 63). A message contains 1 [data] section for each set of Component and related criteria's.

Field	Name	Data type	Comment
1	Name of the row	String	Fixed. Always [data]
2	Component	String	Name of the component: See "2.9.3.1 Imbalance components "page 57
3	Party/Area	String	The party or Area related to the component: "2.9.3.3 Imbalance components added parameters " p 63
3	Direction of Power flow	String	Identification of the direction of flow (see section see "2.9.3.2 Imbalance components "page61). Possible values are: <ul style="list-style-type: none"> <li>• OUT: the energy is going out the BRP Balance perimeter</li> <li>• IN: the energy is coming in the BRP balance perimeter</li> </ul>

Table 26 CSV Transfer of Energy (ToE) Delivered volumes message [data] fields

### 3.10.1.3. Transfer of Energy (ToE) delivered volumes [schedule]

The [schedule] section contains the metering values and their status. A [schedule] is always related to a parent [data] section. Each [data] section should have one [schedule] section for each day of the covered month but any time period is theoretically possible.

Field	Name	Data type	Comment
1	Name of the row	String	Fixed. Always [schedule]
2	Start date and time	Date	Start date and time of the schedule in ISO 8601 format (see section Appendix E, page 258).
3	Duration	Integer	Total number of minutes in the schedule. (! See also section Appendix E, page 258 on the effect of daylight saving.)
4	Period	Integer	Number of minutes for each value period. Always 15.
5	Power type	String	<p>Identification of the type of power* (see section 1.1.1). Possible values are:</p> <ul style="list-style-type: none"> <li>• A: Active</li> <li>• I: Inductive</li> <li>• C: Capacitive</li> </ul> <p>* Normally only Active power type are part of the Imbalance message but theoretically other power type could also exist</p>
6	Metering type	String	<p>Indication as to whether the values are net or gross* or specific (see section 1.1.3.4). Possible values are</p> <ul style="list-style-type: none"> <li>• N: Net</li> <li>• G: Gross</li> <li>• GG: "Green Gross"</li> <li>• GC: "Gross CIPU"</li> </ul> <p>* Normally only Net metering type are part of the Imbalance message but theoretically other metering type could also exist</p>
7	Compensation type	String	<p>Indication as to whether the values are compensated or not* (see section 1.1.3.1). Possible values are:</p> <ul style="list-style-type: none"> <li>• NC: Non-Compensated. Used for metering purposes.</li> <li>• C: Compensated. Used for billing purposes</li> <li>• A: Reserved for future use</li> <li>• CC: Compensated Corrected Used for specific purposes</li> </ul> <p>* Normally only Compensated are part of the Imbalance message but theoretically other Compensation type could also exist</p>





6	Version	String	The version of the message: An integer within range [1...999]. <b>Note:</b> The first message sent is not guaranteed to have version 1.
---	---------	--------	---

Table 28 CSV Real-Time DGO Allocation [header] fields

### 3.11.1.2. Real-Time DGO Allocation [data]

The [data] section is composed of one line. Each [data] section in the message identifies the Component, the direction of the power flow (see "2.11.3.2.2"page 76), and the party or the Area the component to which the data relates. The Real-Time DGO Allocation message contains two [data] sections, one for the Real-Time DGO Allocation Estimated value and another for the estimation quality (in %).

Field	Name	Data type	Comment																																													
1	Name of the row	String	Fixed. Always [data]																																													
2	Component	String	Name of the component: See see "2.11.3.2.2"page 76)																																													
3	Party/Area	String	The party or Area related to the component: see 2.9.3.3																																													
			<table border="1"> <thead> <tr> <th>Old Component</th> <th>Flow direction</th> <th></th> </tr> </thead> <tbody> <tr> <td>R1CorrTotal</td> <td>In</td> <td>Y</td> </tr> <tr> <td>R2UpCorrTotal</td> <td>Out</td> <td>N</td> </tr> <tr> <td>R2DownCorrTotal</td> <td>In</td> <td>N</td> </tr> <tr> <td>R3AndCipuUpCorrTotal</td> <td>Out</td> <td>N</td> </tr> <tr> <td>R3AndCipuDownCorrTotal</td> <td>In</td> <td>N</td> </tr> <tr> <td>R3EUUpbyBSP</td> <td>Out</td> <td>N</td> </tr> <tr> <td>R3EDownbyBSP</td> <td>In</td> <td>N</td> </tr> <tr> <td>R3ETotal</td> <td>In</td> <td>Y</td> </tr> <tr> <td>DchCompensationTotal</td> <td>Out</td> <td>Y</td> </tr> <tr> <td>mFRRnonCipuBrpSourceCorrTotal</td> <td>In</td> <td>Y</td> </tr> <tr> <td>mFRRnonCipuBrpBspCorrTotal</td> <td>In</td> <td>Y</td> </tr> <tr> <td>mFRRnonCipuBrpBspUpCorr</td> <td>Out</td> <td>N</td> </tr> <tr> <td>mFRRnonCipuBrpBspDownCorr</td> <td>In</td> <td>N</td> </tr> <tr> <td>mFRRnonCipuTotal</td> <td>In</td> <td>Y</td> </tr> </tbody> </table>	Old Component	Flow direction		R1CorrTotal	In	Y	R2UpCorrTotal	Out	N	R2DownCorrTotal	In	N	R3AndCipuUpCorrTotal	Out	N	R3AndCipuDownCorrTotal	In	N	R3EUUpbyBSP	Out	N	R3EDownbyBSP	In	N	R3ETotal	In	Y	DchCompensationTotal	Out	Y	mFRRnonCipuBrpSourceCorrTotal	In	Y	mFRRnonCipuBrpBspCorrTotal	In	Y	mFRRnonCipuBrpBspUpCorr	Out	N	mFRRnonCipuBrpBspDownCorr	In	N	mFRRnonCipuTotal	In	Y
			Old Component	Flow direction																																												
			R1CorrTotal	In	Y																																											
			R2UpCorrTotal	Out	N																																											
			R2DownCorrTotal	In	N																																											
			R3AndCipuUpCorrTotal	Out	N																																											
			R3AndCipuDownCorrTotal	In	N																																											
			R3EUUpbyBSP	Out	N																																											
			R3EDownbyBSP	In	N																																											
			R3ETotal	In	Y																																											
			DchCompensationTotal	Out	Y																																											
			mFRRnonCipuBrpSourceCorrTotal	In	Y																																											
			mFRRnonCipuBrpBspCorrTotal	In	Y																																											
			mFRRnonCipuBrpBspUpCorr	Out	N																																											
mFRRnonCipuBrpBspDownCorr	In	N																																														
mFRRnonCipuTotal	In	Y																																														
Imbalance components added parameters "page 63																																																
3	Direction of Power flow	String	<p>Identification of the direction of flow (see section see "2.9.3.2 Imbalance components added parameters"page 61).</p> <p>Possible values are:</p> <ul style="list-style-type: none"> <li>IN: the energy is coming in the BRP balance perimeter. Note that n... sent, when the energy exists the BRP balance perimeter.</li> </ul>																																													

Table 29 CSV Real\_Time DGO Allocation message [data] fields

### 3.11.1.3. Real-Time DGO Allocation [schedule]

The [schedule] section contains the metering values and their status. A [schedule] is always related to a parent [data] section. Each [data] section should have one [schedule] section for each day of the covered month but any time period is theoretically possible.

Field	Name	Data type	Comment
1	Name of the row	String	Fixed. Always [schedule]
2	Start date and time	Date	Start date and time of the schedule in ISO 8601 format (see section Appendix E, page 258).
3	Duration	Integer	Total number of minutes in the schedule. (! See also section Appendix E, page 258 on the effect of daylight saving.)
4	Period	Integer	Number of minutes for each value period. Always 15.
5	Power type	String	Identification of the type of power* (see section 1.1.1). Possible values are: <ul style="list-style-type: none"> <li>• A: Active</li> <li>• I: Inductive</li> <li>• C: Capacitive</li> </ul> * Normally only Active power type are part of the Imbalance message but theoretically other power type could also exist
6	Metering type	String	Indication as to whether the values are net or gross* or specific (see section 1.1.3.4). Possible values are <ul style="list-style-type: none"> <li>• N: Net</li> <li>• G: Gross</li> <li>• GG: "Green Gross"</li> <li>• GC: "Gross CIPU"</li> </ul> * Normally only Net metering type are part of the Imbalance message but theoretically other metering type could also exist
7	Compensation type	String	Indication as to whether the values are compensated or not* (see section 1.1.3.1). Possible values are: <ul style="list-style-type: none"> <li>• NC: Non-Compensated. Used for metering purposes.</li> <li>• C: Compensated. Used for billing purposes</li> <li>• A: Reserved for future use</li> <li>• CC: Compensated Corrected Used for specific purposes</li> </ul>



			* Normally only Compensated are part of the Imbalance message but theoretically other Compensation type could also exist
8	Profile type	String	<p>Indication of the load profile*. This field is reserved for possible future use and has no significant meaning. Currently, values could be:</p> <ul style="list-style-type: none"> <li>• ALP: Aggregated load profile</li> <li>• ULP: Undefined load profile</li> </ul> <p>* Normally only ALP are part of the Imbalance message but theoretically ULP type could also exist</p>
9	Unit	String	<p>Unit in which the metered values are defined.</p> <p>Normally always KW</p>
10 to 202 in steps of 2	Value	Signed Decimal	<p>Value of the metered quantity in the unit defined in Field 9 above with a maximum of 3 digits after the decimal point.</p> <ul style="list-style-type: none"> <li>• If the value is positive then no "+" sign is added</li> <li>• If the value is negative then "-" sign is added</li> </ul>
11 to 203 in steps of 2	Quality	1 char	<p>Indication as to the quality of the metered data (see section 1.1.3.3). Possible values are:</p> <ul style="list-style-type: none"> <li>• N: Normal</li> <li>• I: Inexact</li> <li>• S: Substituted (Estimated replacement).</li> </ul>

Table 30 CSV Real\_Time DGO Allocation message [schedule] fields

## Chapter 4 XML format messages

This chapter describes in detail the content of XML format messages. This information is destined for the developer implementing this data in a business application.

General concepts concerning metering data are explained in "1.2 Messages" p 14. An introduction to the contents of XML messages is given in Chapter 2, "Understanding messages".

Please note that only XML Schemas (XSD) are available. No DTD or WSDL are available.

	<p><b>Warning</b></p> <p>When implementing business applications using metered data, you should take account of day-light saving issues as explained in section 6.5.2 on page 246.</p>
---	--

### 4.1. Reference XSD

Elia XML messages allow automatic validation by the client application using only the "XML Schemas" (XSD)

Schema	Description
<a href="http://nedi1.elia.be/namespaces/public/metering/Publication.xsd">http://nedi1.elia.be/namespaces/public/metering/Publication.xsd</a>	<ul style="list-style-type: none"> <li>• Access Point messages described on page 134.</li> <li>• Infeed TSO per substation messages described on page 136.</li> <li>• Infeed TSO per substation messages and per supply bay described on page 143.</li> <li>• GEMP messages described on page 145.</li> <li>• Metering Point messages described on page 136</li> </ul>
<a href="http://nedi1.elia.be/namespaces/public/metering/ELIA-iec62325-451-4-settlement.xsd">http://nedi1.elia.be/namespaces/public/metering/ELIA-iec62325-451-4-settlement.xsd</a> <a href="http://nedi1.elia.be/namespaces/public/Metering/urn-entsoe-eu-wgedi-codelists.xsd">http://nedi1.elia.be/namespaces/public/Metering/urn-entsoe-eu-wgedi-codelists.xsd</a> <a href="http://nedi1.elia.be/namespaces/public/Metering/urn-entsoe-eu-local-extension-types.xsd">http://nedi1.elia.be/namespaces/public/Metering/urn-entsoe-eu-local-extension-types.xsd</a>	Local implementation of the standard where 2 fields (meteringType and calculationMethod) and local codes have been added

### 4.2. XML Access Point messages

This message concerns the metering data related to a specific Access Point. Access Point messages are regulated messages. For a general explanation of the content of these messages see section 2.1.

#### 4.2.1. Message structure

The <AccessPointValues> file consists of a <header> element, which refers to the message and a <data-list> element which contains the power transfer data.

```
<?xml version="1.0" encoding="iso-8859-1" standalone="yes"?>
<AccessPointValues xmlns="http://www.elia.be/namespaces/public/evms/b2bmsg">
+ <header>
+ <data-list>
</AccessPointValues>
```

##### 4.2.1.1. <header>

The <header> element is mandatory. There is one <header> in the message which identifies the sender and receiver of the message as well as the time the message was created.

```
<header>
+ <sender>
+ <receiver>
```

```
<timestamp>2004-02-05T09:31:10Z</timestamp>
</header>
```

The contents of the <header> element are listed in the table below.

Element name	Element content	Content type	Cardinality	Description
<sender>	elements	<party> elements, (see section 4.16.1 on page 191).	mandatory	Identification of message sender
<receiver>	elements		mandatory	Identification of message receiver
<timestamp>	text	date (see page 195)	mandatory	Creation time of the message

Table 31 XML <header> element for Access Point messages

#### 4.2.1.2. <data-list>

The <datalist> element contains a number of <data> elements. Each of the <data> elements identifies the power transferred and the Access Point. The direction of the transfer of power is indicated by the optional <partyFrom> and <partyTo> elements.

```
<datalist>
  <data>
    + <partyFrom>
    + <partyTo>
    + <schedule-list>
    + <point>
  </data>
</datalist>
```

The contents of each <data> element are listed in the table below.

Element name	Element content	Content type	Cardinality	Description
<partyFrom>	elements	<party> elements, (see section 4.16.1 on page 191).	optional	Fields identifying the party FROM which the power is flowing.
<partyTo>	elements		optional	Field identifying the party TO which the power is flowing
<schedule-list>	elements	<schedule> elements (see section 4.16.3 on page 193.)	mandatory	Fields identifying the characteristics of the transferred power and the values.
<point>	elements	<point> elements (see section 4.16.2 on page 192).	mandatory	Fields identifying the Access Point

Table 32 XML <data> element for Access Point messages

### 4.3. XML Metering Point messages

For a general explanation of the content of these messages see section "2.3 Metering Point " p 29. The information in this section provides details on the fields and their possible values for use in the implementation of client applications.

The <MeteringPointValues > file consists of a <header> element, which refers to the message and a <data-list> element which contains the power transfer data.

```
<?xml version="1.0" encoding="iso-8859-1"?>
<MeteringPointValues xmlns="http://www.elia.be/namespaces/public/evms/b2bmsg">
+ <header>
+ <data-list>
</MeteringPointValues>
```

#### 4.3.1. <header>

The <header> element is mandatory. There is one <header> in the message which identifies the sender and receiver of the message as well as the time the message was created.

```
<header>
+ <sender>
+ <receiver>
  <timestamp>2004-02-05T09:31:10Z</timestamp>
</header>
```

The contents of the <header> element are listed in the table below.

Element name	Element content	Content type	Cardinality	Description
<sender>	elements	<party> elements, (see section 4.16.1 on page 191).	mandatory	Identification of message sender
<receiver>	elements		mandatory	Identification of message receiver
<timestamp>	text	date (see page 195)	mandatory	Time at which the message was created.

Table 33 XML <header> element for Metering Point messages

### 4.3.2. <data-list>

The <data-list> element contains a number of <data> elements. Each of the <data> elements identifies the data values and the Access Point.

```
<data-list>
  <data>
    + <partyFrom>
    + <partyTo>
    + <schedule-list>
      <MPEanCode>8714252005707</MPEanCode>
  </data>
</data-list>
```

The contents of each <data> element are listed in the table below.

Element name	Element content	Content type	Cardinality	Description
<partyFrom>	elements	<party> elements, see section 4.16.1 on page 191	optional	Optional field indicating the direction of flow if the data is power.
<partyTo>	elements		optional	
<schedule-list>	elements	<schedule> elements (see section 4.16.3, page 193).		Fields identifying the characteristics of the metered data and their values.
<MPEanCode>	text	string (see page 195)	mandatory	Metering Point EAN Code

Table 34 XML <data> element for Metering Point messages

## 4.4. XML CDS Loop Losses (PBO) messages

For a general explanation and especially the concept of component in the CDS Loop Losses (PBO) message, see section "2.5.2 Accessing CDS Loop Losses (PBO) Message " p 38

The XML CDS Loop Losses (PBO) message has a structure which is different of the "Classic" metering messages but similar to the XML Imbalance message.

The Elia goal is to replace in a near future all the Metering XML messages in order to cope with European and worldwide standards that are available now: the current CDS Loop Losses (PBO) message respects the **IEC standard 62325-451-4**

The XML structure is explained in this document but whole description is available on the IEC web store: <https://webstore.iec.ch/publication/29116> (document on purchase)

```
<EnergyAccount_MarketDocument
xsi:schemaLocation="urn:iec62325.351:tc57wg16:451-4:energyaccountdocument:4:0
iec62325-451-4-settlement_v4.xsd" xmlns="urn:iec62325.351:tc57wg16:451-
4:energyaccountdocument:4:0" xmlns:xsi="http://www.w3.org/2001/XMLSchema-
instance">
  <mRID>CDSPBO_20150801_20150831</mRID>
  <revisionNumber>10</revisionNumber>
  <type>Z01</type>
  <docStatus><value>A02</value></docStatus>
  <process.processType>A05</process.processType>
  <process.classificationType>A01</process.classificationType>
  <sender_MarketParticipant.mRID
codingScheme="A01">10X1001A1001A094</sender_MarketParticipant.mRID>
```

```

    <sender_MarketParticipant.marketRole.type>CDSO</sender_MarketParticipa
nt.marketRole.type>
    <receiver_MarketParticipant.mRID codingScheme="A01">22XCDSOPERATOR-
4</receiver_MarketParticipant.mRID>
    <receiver_MarketParticipant.marketRole.type>Z01</receiver_MarketPartic
ipant.marketRole.type>
    <createdDateTime>2015-11-22T23:00:00Z</createdDateTime>
    <period.timeInterval><start>2015-07-31T22:00Z</start><end>2015-08-
30T22:00Z</end></period.timeInterval>
    <domain.mRID codingScheme="A01">10YBE-----2</domain.mRID>
    <TimeSeries>

```

Example 82 Example of PBO message

#### 4.4.1. XML CDS Loop Losses (PBO) Header fields

The following header fields are mandatory and are listed in the table below.

Element name	Content type	Description
mRID	String [1..35]	The unique identification of the document. Currently: "CDSPBO_[First day of the period covered:YYYYMMDD]_[Last day of the covered period:YYYYMMDD]" Example: CDSPBO_20150801_20150831 Remark: the only constraint of this field is to be unique for a given period. It could therefore change in the future.
revisionNumber	Integer [1...999]	The version number of the document: A more recent document has a higher version number. It is not guaranteed that first document received by the Recipient has version number 1.
type	String [3]	Fixed. Always Z01 (PBO document)
docStatus	String [3]	The status of the PBO document. Possible values: <ul style="list-style-type: none"> <li>A01 - Intermediate : used for non-validated messages</li> <li>A02 - Final : used for validated message</li> <li>A03 - Final Modified : used for corrections after publication of a validated message</li> </ul> See "1.2.8 Regulated messages & message delivery frequency "page19
process.processType	String [3]	The type of the PBO document. Possible values: <ul style="list-style-type: none"> <li>A05 - Metered data aggregation</li> </ul>
process.classificationType	String [3]	The classification mechanism used to group a set of objects together within a business process. Possible values: <ul style="list-style-type: none"> <li>A01 - Detail</li> <li>A02 - Summary</li> </ul> Normally only A01 is used within the PBO message but theoretically other classificationType could also exist

sender_MarketParticipant.mRID	codingScheme: String [3] Value: String [16]	Fixed: <ul style="list-style-type: none"> <li>codingScheme: A01 (EIC code)</li> <li>10X1001A1001A094 (Elia EIC code)</li> </ul>
sender_MarketParticipant.marketRole.type	String [3]	Fixed: Always A04 (System operator)
receiver_MarketParticipant.mRID	codingScheme: String [3] Value: String [16]	<ul style="list-style-type: none"> <li>codingScheme: Fixed A01 (EIC code)</li> <li>Value : EIC code of the CDS Operator</li> </ul>
receiver_MarketParticipant.marketRole.type	String [3]	Fixed: Always Z01 (CDS Operator)
createdDateTime	Date and time (see page 195)	Time at which the message was created.
period.timeInterval	Start / End: Date page 195	Covered Period: Normally this is exactly one month (in UTC time). Example for the month August 2015: Start time is 31/7/2015 at 22h. End time is 31/8/2015 at 22h However any period is theoretically possible.
Domain.mRID	codingScheme: String [3] Value: String [16]	Fixed: <ul style="list-style-type: none"> <li>codingScheme: A01 (EIC code)</li> <li>10YBE-----2 (Belgian Area)</li> </ul>

Table 35 XML headers elements for PBO messages

#### 4.4.2. XML CDS Loop Losses (PBO) TimeSeries fields

The <TimeSeries> element contains information to characterize the Component and related data

It contains also the Period element

```
<mRID>Z01541416004540000143</mRID>
<businessType>Z01</businessType>
<product>8716867000016</product>
<objectAggregation>A01</objectAggregation>
<area_Domain.mRID codingScheme="A01">541416004540000143</area_Domain.mRID>
<measure_Unit.name>KWT</measure_Unit.name>
<Period>
```

Example 83 CDS PBO Time Series element

All elements are mandatory and listed in the table below.

Element name	Content type	Description
mRID	String [1..35]	Time series unique identification within the current message
businessType	String [3]	Fields identifying the characteristics of the component defined in "2.5.3.1 CDS Loop Losses (PBO) components " p 38: See table below
product	String [1..35]	Fixed. Always 8716867000030
objectAggregation	String [3]	Fixed. Always A01

area_Domain.mRID	String [1..18]	The EAN code of the CDS Access Point
marketParticipant.mRID	String [1..18]	Currently not used
measure_Unit.name	String [3]	Power unit. Always KWT
Period	See "4.4.3 XML CDS Loop Losses (PBO) Period fields " p 140	

Table 36 XML &lt;data&gt; element for CDS Loop Losses (PBO) messages

Component	Business Type	Flow direction
CDSLooLosses	Z01 - Clearing Difference	In
CDSInfeedOfftakeTotal and CDSInfeedInjectionTotal	A66 - Energy flow	Out and In
CDSAllocationOfftakeTotal and CDSAllocationInjectionTotal	A14 - Aggregated energy data	Out and In
CDSAccessPointsOfftakeTotal and CDSAccessPointsInjectionTotal	A65 - Accounting Point Relevant data	In and Out

Table 37 XML CDS Loop Losses (PBO) Time Series component and related data

#### 4.4.3. XML CDS Loop Losses (PBO) Period fields

The <Period> element contains information to characterize the power value and quality for a period.

```
<Period>
  <timeInterval>
    <start>2015-07-31T22:00Z</start>
    <end>2015-08-30T22:00Z</end>
  </timeInterval>
  <resolution>PT15M</resolution>
  <Point>
```

All elements are mandatory and listed in the table below.

Element name	Content type	Description
period.timeInterval	Start / End: Date page 195	Covered Period: Normally this is exactly one month in ISO 8601 format (see section "4.17 Data types "page195 ).
resolution	String	Total number of minutes in the schedule. (! See also section 6.5, page 74 on the effect of daylight saving.)
Point	See below	

Table 38 XML CDS PBO Time Series component and related data

#### 4.4.4. XML CDS Loop Losses (PBO) Point fields

The <Point> element contains information to characterize the power value and quality for a position.

```
<Point>
```



```

<position>2</position>
<in_Quantity.quantity>113423.485</in_Quantity.quantity>
<in_Quantity.quality>A04</in_Quantity.quality>
<out_Quantity.quantity>542630.839</out_Quantity.quantity>
<out_Quantity.quality>A04</out_Quantity.quality>
</Point>

```

Element name	Cardinality	Content type	Description
position	Mandatory	Integer [1...2884]	The position of the quarter within the covered period
in_Quantity.quantity	Optional	Double	Value for the direction IN (if possible for the component) or the element is not present
in_Quantity.quality	Optional	Element	Quality for the direction IN (if possible for the component) or the element is not present Possible values: <ul style="list-style-type: none"> <li>• Normal : "A04"</li> <li>• Inexact: "A02"</li> <li>• Substituted: "A01"</li> </ul>
out_Quantity.quantity	Optional	Double	Value for the direction OUT (if possible for the component) or the element is not present
out_Quantity.quality	Optional	Element	Quality for the direction OUT (if possible for the component) or the element is not present Possible values: <ul style="list-style-type: none"> <li>• Normal : "A04"</li> <li>• Inexact: "A02"</li> <li>• Substituted: "A01"</li> </ul>

Table 39 XML <Point> element for PBO messages

#### 4.5. XML Infeed TSO per substation messages

This type of message is delivered to Distribution Grid Operators and Meter Reading Companies. These messages provide metering values for all the power transferred from Elia across a distribution point associated with a substation. Each distribution point can have a number of Access Points associated with it that are managed by different clients. Infeed TSO per substation messages are regulated messages. For a general explanation of the content of these messages see section 0.

The information in this section provides details on the fields and their possible values for use in the implementation of client applications.

The <TSO\_MRCO\_DP> file consists of a <header> element, which refers to the message and a <data-list> element which contains the power transfer data.

```

<?xml version="1.0" encoding="iso-8859-1" standalone="yes"?>
< TSO_MRCO_DP xmlns="http://www.elia.be/namespaces/public/evms/b2bmsg">
+ <header>
+ <data-list>
</ TSO_MRCO_DP>

```

#### 4.5.1.1. <header>

The <header> element is mandatory. There is one <header> in the message which identifies the sender and receiver of the message as well as the time the message was created.

```
<header>
+ <sender>
+ <receiver>
  <timestamp>2004-02-05T09:31:10Z </timestamp>
</header>
```

The contents of the <header> element are listed in the table below.

Element name	Element content	Content type	Cardinality	Description
<sender>	elements	<party> elements, (see section 4.16.1 on page 191).	mandatory	Identification of message sender
<receiver>	elements		mandatory	Identification of message receiver
<timestamp >	text	date (see page 195)	mandatory	Time at which the message was created.

Table 40 XML <header> element for Infeed TSO per **substation** messages

#### 4.5.1.2. <data-list>

The <data-list> element contains a number of <data> elements. Each of the <data> elements identifies the distribution point and well as the list of Access Points associated with the distribution point. Each DGO that uses a distribution point has a specific Access Point – see Figure 10 on page 43. The direction of the transfer of power is indicated by the optional <partyFrom> and <partyTo> elements.

```
<data-list>
<data>
+ <partyFrom>
+ <partyTo>
+ <schedule-list>
+ <accessPoints-list>
  <DPEanCode>1234567899876</DPEanCode>
</data>
</data-list>
```

The contents of each <data> element are listed in the table below.

Element name	Element content	Content type	Cardinality	Description
<partyFrom>	elements	<party> elements, (see section 4.16.1 on page 191).	optional	Fields identifying the party FROM which the power is flowing.
<partyTo>	elements		optional	Fields identifying the party TO which the power is flowing.
<schedule-list>	elements	<schedule> elements (see section 4.16.3 on page 193)	mandatory	Fields identifying the characteristics of the transferred power and the values.
<accessPoints-list>	elements	<point> elements (see	mandatory	Number of Access Points associated with the distribution point and for

		section 4.16.2 on page 192).		which data is included in the message (see Figure 10 on page 43).
<DPEanCode>	text	String (see page 195).	mandatory	EAN-GSRN code of the Distribution Point associated with the substation (see section 0)

Table 41 XML <data> element for Infeed TSO per substation messages

## 4.6. XML Infeed TSO per substation and per supply bay messages

This type of message is delivered to Distribution Grid Operators and Meter Reading Companies. These messages provide metering values for all the power transferred from Elia across a distribution connection point/supply bay within a substation. Infeed TSO per substation and supply bay messages are regulated messages. For a general explanation of the content of these messages see section 2.7.

The information in this section provides details on the fields and their possible values for use in the implementation of client applications.

The <TSO\_DGOCP> file consists of a <header> element, which refers to the message and a <data-list> element which contains the power transfer data.

```
<?xml version="1.0" encoding="iso-8859-1" standalone="yes"?>
<TSO_DGOCP xmlns="http://www.elia.be/namespaces/public/evms/b2bmsg">
  <header>
    <data-list>
  </TSO_DGOCP>
```

### 4.6.1.1. <header>

The <header> element is mandatory. There is one <header> in the message which identifies the sender and receiver of the message as well as the time the message was created.

```
<header>
  <sender>
  <receiver>
  <timestamp>2004-02-05T09:31:10Z </timestamp>
</header>
```

The contents of the <header> element are listed in the table below.

Element name	Element content	Content type	Cardinality	Description
<sender>	elements	<party> elements, (see section 4.16.1 on page 191).	mandatory	Identification of message sender
<receiver>	elements		mandatory	Identification of message receiver
<timestamp>	text	date (see page 195)	mandatory	Time at which the message was created.

Table 42 XML <header> element for Infeed TSO per substation and per supply bay messages

#### 4.6.1.2. <data-list>

The <data-list> element contains a number of <data> elements. Each of the <data> elements identifies the distribution supply bay. The direction of the transfer of power is indicated by the optional <partyFrom> and <partyTo> elements.

```

<data-list>
  <data>
    <partyFrom>
    <partyTo>
    <schedule-list>
    <DCPEanCode>1234567899876</DCPEanCode>
  </data>
</data-list>

```

The contents of each <data> element are listed in the table below.

Element name	Element content	Content type	Cardinality	Description
<partyFrom>	elements	<party> elements, (see section 4.16.1 on page 191).	optional	Fields identifying the party FROM which the power is flowing.
<partyTo>	elements		optional	Fields identifying the party TO which the power is flowing.
<schedule-list>	elements	<schedule> elements (see section 4.16.3 on page 193)	mandatory	Fields identifying the characteristics of the transferred power and the values.
<DCPEanCode>	text	String (see page 195).	mandatory	EAN-GSRN code of the Distribution supply bay within the substation (see section 2.7)

Table 43 XML <data> element for Infeed TSO per substation and per supply bay messages

## 4.7. XML GEMP messages

For a general explanation of the content of these messages see section 2.8.

A GEMP is a Global Elia Metered Position. This type of message provides aggregated metering data to both Access Responsible Parties (BRPs). The metered data values are summed over the whole of Belgium, over regions for which a regulator is defined, and over the regions with respect to a supplier. These are regulated messages.

The information in this section provides details on the fields and their possible values for use in the implementation of client applications.

### 4.7.1. Message structure

The summed metered data is supplied in a single message (contained in the <ARPAAllGemp> root element) which contains 3 sub sections.

```
<?xml version="1.0" encoding="iso-8859-1" standalone="yes"?>
<ARPAAllGemp xmlns="http://www.elia.be/namespaces/public/evms/b2bmsg">
+ <ARPGemp>
+ <ARPRRegionGemp>
+ <ARPSupplierGemp>
</ARPAAllGemp>
```

<ARPGemp> contains the global summed data and is described on page 145.

<ARPRRegionGemp> contains the data summed per region and is described on page 146.

<ARPSupplierGemp> contains the data summed per region and per supplier and is described on page 148.

### 4.7.2. ARPGemp

The <ARPGemp> element contains the global summation for all Access Points in Belgium that are in the scope of responsibility of the BRP. It consists of a <header>, which concerns the message and a <data-list> which contains the power transfer data.

```
<ARPGemp>
+ <header>
+ <data-list>
</ARPGemp>
```

#### 4.7.2.1. <header>

The <header> element is mandatory. There is one <header> in the <ARPGemp> element which identifies the sender and receiver of the message, the time the message was created and the type of message.

```
<header>
+ <sender>
+ <receiver>
  <timestamp>2004-07-02T10:23:08Z</timestamp>
  <MsgGempType>
</header>
```

The contents of the <header> element are listed in the table below.

Element name	Element content	Content type	Cardinality	Description
<sender>	elements	<party> elements, (see section 4.16.1 on page 191)	mandatory	Identification of message sender
<receiver>	elements		mandatory	Identification of message receiver
<timestamp>	text	date (see page 195)	mandatory	Time at which the message was created.
<MsgGempType>	text	string	optional	Fixed:GEMP ARP

Table 44 XML <header> element for ARPGemp elements

#### 4.7.2.2. <data-list>

Contains a number of <data> sections. Each of the <data> sections identifies the direction of the transfer of power, by the optional <partyFrom> and <partyTo> elements, and the summed power values.

```
<data-list>
  <data>
    + <partyFrom>
    + <partyTo>
    + <schedule-list>
  </data>
</data-list>
```

The contents of each <data> section are listed in the table below.

Element name	Element content	Content type	Cardinality	Description
<partyFrom>	elements	<party> elements, (see section 4.16.1 on page 191).	optional	Fields identifying the party FROM which the power is flowing.
<partyTo>	elements		optional	Fields identifying the party TO which the power is flowing.
<schedule-list>	elements	<schedule> elements (see section 4.16.3 on page 193).	mandatory	Fields identifying the characteristics of the transferred power and their values.

Table 45 XML <data> element for ARPGemp elements

#### 4.7.3. ARPRegionGemp

The <ARPRegionGemp> element contains the sum of metering data for all Access Points that are in the scope of responsibility of the BRP or Supplier in each regulated region. It consists of a <header>, which concerns the message and a <data-list> which contains the power transfer data.

```
<ARPRegionGemp>
  + <header>
```

```
+ <data-list>
</ARPRRegionGemp>
```

#### 4.7.3.1. <header>

The <header> element is mandatory. There is one <header> in the <ARPRRegionGemp> element which identifies the sender and receiver of the message, time the message was created and the type of message.

```
<header>
+ <sender>
+ <receiver>
  <timestamp>2004-07-02T10:23:08Z</timestamp>
  <MsgGempType>
</header>
```

The contents of the <header> element are listed in the table below.

Element name	Element content	Content type	Cardinality	Description
<sender>	elements	<party> elements, (see section 4.16.1 on page 191).	mandatory	Identification of message sender
<receiver>	elements		mandatory	Identification of message receiver
<timestamp>	text	date (see page 195)	mandatory	Time at which the message was created.
<MsgGempType>	text	string	optional	Fixed:GEMP ARP

Table 46 XML <header> element for ARPRRegionGemp elements

#### 4.7.3.2. <data-list>

The <data-list> element contains a number of <data> elements. Each of the <data> sections identifies the direction of the transfer of power, by the optional <partyFrom> and <partyTo> elements, the summed power values per region and the region over which the values are summed.

```
<data-list>
<data>
+ <partyFrom>
+ <partyTo>
+ <schedule-list>
  <region>BRU</region>
</data>
</data-list>
```

The contents of each <data> section are listed in the table below.

Element name	Element content	Content type	Cardinality	Description
<partyFrom>	elements	<party> elements, (see section 4.16.1 on page 191).	optional	Fields identifying the party FROM which the power is flowing.
<partyTo>	elements		optional	Fields identifying the party TO which the power is flowing.
<schedule-list>	elements	<schedule> elements (see section 4.16.3 on page 193).	mandatory	Fields identifying the characteristics of the transferred power and their values.

<code>&lt;region&gt;</code>	text	string (see page 195).	mandatory	<p>Field indicating the region over which the values are summed.</p> <ul style="list-style-type: none"> <li>• Possible values are:</li> <li>• FLE: Flemish region</li> <li>• WAL: Wallonia region</li> <li>• BRU: Brussels region</li> <li>• FED: Federal region. This region contains all Access Points that are on the 380/220/150 kV network (independently of the physical location).</li> </ul>
-----------------------------	------	------------------------	-----------	--

Table 47 XML `<data>` element for `ARPRRegionGemp` elements

#### 4.7.4. ARPSupplierGemp

The `<ARPSupplierGemp>` element contains the sum of metering data for all Access Points that are in the scope of responsibility of the BRP in each regulated region and for each supplier. It consists of a `<header>`, which concerns the message and a `<data-list>` which contains the power transfer data.

```
<ARPSupplierGemp>
+ <header>
+ <data-list>
</ARPSupplierGemp>
```

##### 4.7.4.1. <header>

The `<header>` element is mandatory. There is one `<header>` in the `<ARPSupplierGemp>` element which identifies the sender and receiver of the message, the time the message was created and the type of message.

```
<header>
+ <sender>
+ <receiver>
  <timestamp>2004-07-02T10:23:08Z</timestamp>
  <MsgGempType>
</header>
```

The contents of the `<header>` element are listed in the table below.

Element name	Element content	Content type	Cardinality	Description
<code>&lt;sender&gt;</code>	elements	<code>&lt;party&gt;</code> elements, (see section 4.16.1 on page 191).	mandatory	Identification of message sender
<code>&lt;receiver&gt;</code>	elements		mandatory	Identification of message receiver
<code>&lt;timestamp&gt;</code>	text	date (see page 195)	mandatory	Time at which the message was created.



<MsgGempType>	text	string	optional	Fixed:GEMP ARP
---------------	------	--------	----------	----------------

Table 48 XML &lt;header&gt; element for ARPSupplierGemp elements

#### 4.7.4.2. <data-list>

The <data-list> element contains a number of <data> elements. Each of the <data> sections identifies the direction of the transfer of power, by the optional <partyFrom> and <partyTo> elements, the summed power values, the region and the supplier over which the values are summed.

```

<data-list>
  <data>
    + <partyFrom>
    + <partyTo>
    + <schedule-list>
      <region>BRU</region>
      <supplierEicCode>11SUPP-B-----P</supplierEicCode >
  </data>
</data-list>

```

The content of each <data> section is listed in the table below.

Element name	Element content	Content type	Cardinality	Description
<partyFrom>	elements	<party> elements, (see section 4.16.1, page 191).	optional	Fields identifying the party FROM which the power is flowing.
<partyTo>	elements		optional	Fields identifying the party TO which the power is flowing.
<schedule-list>	elements	<schedule> elements (see section 4.16.3 on page 193).		Fields identifying the characteristics of the transferred power and their values.
<region>	text	string (see page 195).	mandatory	Field indicating the region over which the values are summed. Possible values are: <ul style="list-style-type: none"> <li>• FLE: Flemish region</li> <li>• WAL: Wallonia region</li> <li>• BRU: Brussels region</li> <li>• FED: Federal region, which contains all Access Points on the 380/220/150 kV network (independently of the physical location).</li> </ul>
<supplierEicCode>		string (see page 195)	mandatory	EIC Code of the supplier of the Access Point

Table 49 XML &lt;data&gt; element for ARPSupplierGemp elements

## 4.8. XML Imbalance messages

For a general explanation and especially the concept of component, see section "2.8 Imbalance metering "page32

The XML Imbalance message has a structure which is different of the other metering messages.

The Elia goal is to replace in a near future all the Metering XML messages in order to cope with European and worldwide standards that are available now: the current Imbalance message respects the **IEC standard 62325-451-4**.

The XML structure is explained in this document but whole description is available on the IEC web store: <https://webstore.iec.ch/publication/29116> (document on purchase).

The Reference XML Schema (XSD) address can be found in section "4.1 Reference XSD " p 134.

```
<?xml version="1.0" encoding="iso-8859-1" standalone="yes"?>
<EnergyAccount_MarketDocument
xsi:schemaLocation="urn:iec62325.351:tc57wg16:451-4:energyaccountdocument:4:0
iec62325-451-4-settlement_v4.xsd" xmlns="urn:iec62325.351:tc57wg16:451-
4:energyaccountdocument:4:0" xmlns:xsi="http://www.w3.org/2001/XMLSchema-
instance">
    <mRID>IMB_20150801_20150831</mRID>
    <revisionNumber>10</revisionNumber>
    <type>A12type>
    <docStatus><value>A02</value></docStatus>
    <process.processType>A06</process.processType>
    <process.classificationType>A01</process.classificationType>
    <sender_MarketParticipant.mRID
codingScheme="A01">10X1001A1001A094</sender_MarketParticipant.mRID>
    <sender_MarketParticipant.marketRole.type>A04</sender_MarketParticipan
t.marketRole.type>
    <receiver_MarketParticipant.mRID codingScheme="A01">22XBRPA-----
A</receiver_MarketParticipant.mRID>
    <receiver_MarketParticipant.marketRole.type>A08</receiver_MarketPartic
ipant.marketRole.type>
    <createdDateTime>2015-09-14T22:00:00Z</createdDateTime>
    <period.timeInterval><start>2015-07-31T22:00Z</start><end>2015-08-
31T22:00Z</end></period.timeInterval>
    <domain.mRID codingScheme="A01">10YBE-----2</domain.mRID>
    <TimeSeries>
```

### 4.8.1. XML Imbalance Header fields

The following header fields are mandatory and are listed in the table below.

Element name	Content type	Description
mRID	String [1..35]	<p>The unique identification of the document. Currently: "IMB_[First day of the period covered:YYYYMMDD]_[Last day of the covered period:YYYYMMDD]"</p> <p>Example: IMB_20150801_20150831</p> <p>Please note that this mRID structure is not guaranteed. Any implementation should only refer to this mRID to determine if this message instance was already treated or not.</p>

revisionNumber	Integer [1...999]	The version number of the document: It is not guaranteed that first document received by the BRP has version number 1. A more recent document has a higher version number
type	String [3]	Fixed. Always A12 (Imbalance document)
docStatus	String [3]	The status of the Imbalance document. Possible values: <ul style="list-style-type: none"> <li>• A01 - Intermediate</li> <li>• A02 - Final</li> <li>• A03 - Final Modified</li> </ul>
process.processType	String [3]	The type of the Imbalance document. Possible values: <ul style="list-style-type: none"> <li>• A04 - System Operation closure</li> <li>• A05 - Metered data aggregation</li> <li>• A06 - Imbalance settlement</li> <li>• A99 - Real-Time DGO Allocation (see )</li> <li>• Normally only A06 is part of the Imbalance message but theoretically other processType could also exist</li> </ul>
process.classificationType	String [3]	The classification mechanism used to group a set of objects together within a business process. Possible values: <ul style="list-style-type: none"> <li>• A01 - Detail</li> <li>• A02 - Summary</li> </ul> Normally only A01 is part of the Imbalance message but theoretically other classificationType could also exist
sender_MarketParticipant.mRID	codingScheme: String [3] Value: String [16]	Fixed: <ul style="list-style-type: none"> <li>• codingScheme: A01 (EIC)</li> <li>• 10X1001A1001A094 (Elia EIC)</li> </ul>
sender_MarketParticipant.marketRole.type	String [3]	Fixed: Always A04 (System operator)
receiver_MarketParticipant.mRID	codingScheme: String [3] Value: String [16]	<ul style="list-style-type: none"> <li>• codingScheme: Fixed A01 (EIC)</li> <li>• Value : EIC code of the BRP</li> </ul>
receiver_MarketParticipant.marketRole.type	String [3]	Fixed: Always A08 (Balance Responsible Party / BRP)
createdDateTime	Date and time (see page 195)	Time at which the message was created (in UTC time).
period.timeInterval	Start / End: Date page 195	Covered Period: Normally this is exactly one month (in UTC time). Example for the month August 2015: Start time is 31/7/2015 at 22h. End time is 31/8/2015 at 22h Any period is theoretically possible.
Domain.mRID	codingScheme: String [3]	Fixed: Always <ul style="list-style-type: none"> <li>• codingScheme: A01 (EIC)</li> </ul>

	Value: String [16]	• 10YBE-----2 (Belgian Area)
--	--------------------	------------------------------

Table 50 XML headers elements for Imbalance messages

#### 4.8.2. XML Imbalance TimeSeries fields

The <TimeSeries> element contains information to characterize the Component and related data

It contains also the Period element: see

```
<mRID>A03-22XBRPA-----A</mRID>
<businessType>A03</businessType>
<product>8716867000016</product>
<objectAggregation>A03</objectAggregation>
<area_Domain.mRID codingScheme="A01">10YBE-----2</area_Domain.mRID>
<marketParticipant.mRID codingScheme="A01">22XBRPA-----A
</marketParticipant.mRID>
<measure_Unit.name>KWT</measure_Unit.name>
<Period>
```

All elements are listed in the table below.

Element name	Content type	Description
mRID	String [1..35]	Time series unique identification within the message
businessType	String [3]	Fields identifying the characteristics of the component : See table below
product	String [1..35]	Fixed. Always 8716867000016 - Active Power
objectAggregation	String [3]	Fixed. Always A03
area_Domain.mRID	String [1..18]	Based on the table here below, can be an EAN or EIC code of the Area
marketParticipant.mRID	String [1..18]	Based on the table here below, is the EIC code of the Party
measure_Unit.name	String [3]	Power unit. Always KWT
Period	See "4.8.3 XML Imbalance Period fields" page 155	

Table 51 XML &lt;data&gt; element for Imbalance messages

Component	Business Type	Flow direction	Aggregation	Party/area	XML Grouping
HubPurchasesTotal	A02	In	By Party	BRP EIC code	Grouped
HubSalesTotal	A02	Out	By Party	BRP EIC code	
CrossBorderExportTotal	A03	Out	By Party	BRP EIC code	Grouped
CrossBorderImportTotal	A03	In	By Party	BRP EIC code	
R3AndCipuDownCorrTotal	A10	In	By Party	BRP EIC code	Grouped
R3AndCipuUpCorrTotal	A10	Out	By Party	BRP EIC code	

Component	Business Type	Flow direction	Aggregation	Party/area	XML Grouping
R1CorrTotal	A11	In	By Party	BRP EIC code	
R2DownCorrTotal	A12	In	By Party	BRP EIC code	Grouped
R2UpCorrTotal	A12	Out	By Party	BRP EIC code	
CDSInjection	A14	In	By Area	CDS Network EAN code	Grouped
CDSOfftake	A14	Out	By Area	CDS Network EAN code	
CDSInjectionTotal	A14	In	By Area	ALL CDS EIC code: 22YBE-ALLCDS---3	Grouped
CDSOfftakeTotal	A14	Out	By Area	ALL CDS EIC code: 22YBE-ALLCDS---3	
DGOInjection	A14	In	By Area	DGO Network EAN code	Grouped
DGOOfftake	A14	Out	By Area	DGO Network EAN code	
DGOInjectionTotal	A14	In	By Area	ALL DGO EIC code: 22YBE-ALLDSO---0	Grouped
DGOOfftakeTotal	A14	Out	By Area	ALL DGO EIC code: 22YBE-ALLDSO---0	
OffshoreInterconnectionInjectionTotal	A14	In	By Area	ALL OIP EIC code: 22YBE-ALLOIP---F	Grouped
OffshoreInterconnectionOfftakeTotal	A14	Out	By Area	ALL OIP EIC code: 22YBE-ALLOIP---F	
TSOInjectionTotal	A14	In	By Area	Total on the Elia network: 22YBE-TSO-----9	Grouped
TSOOfftakeTotal	A14	Out	By Area	Total on the Elia network: 22YBE-TSO-----9	
CDSLosesTotal	A15	Out	By Area	ALL CDS EIC code: 22YBE-ALLCDS---3	

Component	Business Type	Flow direction	Aggregation	Party/area	XML Grouping
DGOLossesTotal	A15	Out	By Area	ALL DGO EIC code: 22YBE-ALLDSO---0	
TSOLossesTotal	A15	Out	By Area	Total on the Elia network: 22YBE-TSO-----9	
DchCompensationTotal	A19	Out	By Party	BRP EIC code	
ImbalanceRecipient	A20	In	By party	BRP EIC code	
ImbalanceRecipient	A20	In	By party	HUB BRP EIC code	
OtherDownCorrTotal	A23	In	By party	BRP EIC code	Grouped
OtherUpCorrTotal	A23	Out	By party	BRP EIC code	
ImbalanceResultofthePooling	B32	In	By party	BRP EIC code	
CDSLoopLosses	Z01	Out	By Area	CDS Network EAN code	
CDSLoopLossesTotal	Z01	Out	By Area	ALL CDS EIC code: 22YBE-ALLCDS---3	
DGOLoopLosses	Z01	Out	By Area	DGO Network EAN code	
DGOLoopLossesTotal	Z01	Out	By Area	ALL DGO EIC code: 22YBE-ALLDSO---0	
mFRRnonCipuBrpSourceCorrTotal	Z10	In	By Party	BRP EIC code	
mFRRnonCipuBrpBspCorrTotal	Z11	In	By Party	BRP EIC code	
mFRRnonCipuBrpBspDownCorr	Z19	In	By Party	BSP EIC Code	Grouped
mFRRnonCipuBrpBspUpCorr	Z19	Out	By Party	BSP EIC Code	
mFRRDPpg&DA/IDDownBrpbspCorr	Z20	In	By Party	BRP EIC code	Grouped
mFRRDPpg&DA/IDUpBrpbspCorr	Z20	Out	By Party	BRP EIC code	
mFRRDPpg&DA/IDBrpBspCorrTotal	Z22	In	By Party	BRP EIC code	
mFRRnonCipuTotal	Z24	In	By Party	BRP EIC code	
mFRRCipuAndCipuDownCorrTotal	Z25	In	By Party	BRP EIC code	
mFRRCipuAndCipuUpCorrTotal	Z25	Out	By Party	BRP EIC code	
aFRRUpCorrTotal	Z27	Out	By Party	BRP EIC code	
aFRRDownCorrTotal	Z27	In	By Party	BRP EIC code	

Component	Business Type	Flow direction	Aggregation	Party/area	XML Grouping
mFRRDPpg&DA/IDBrpSourceCorrTotal	Z30	In	By Party	BRP EIC code	
mFRRDPpg&DA/IDTotal	Z31	In	By Party	BRP EIC code	

Table 52 XML Time Series Imbalance component and related data

#### 4.8.3. XML Imbalance Period fields

The <Period> element contains information to characterize the power value and quality for a period

It contains also the Period element: see

```
<Period>
<timeInterval>
  <start>2015-07-31T22:00Z</start>
  <end>2015-08-30T22:00Z</end>
</timeInterval>
<resolution>PT15M</resolution>
<Point>
```

All elements are mandatory and listed in the table below.

Element name	Content type	Description
period.timeInterval	Start / End: Date page 195	Covered Period: Normally this is exactly one month in ISO 8601 format (see section "4.17 Data types "page195 ).
resolution	String	Total number of minutes in the schedule. (! See also section 6.5, page 74 on the effect of daylight saving.)
Point	See below	

Table 53 XML period components and related data

#### 4.8.4. XML Imbalance Point fields

The <Point> element contains information to characterize the power value and quality for a period

```
<Point>
  <position>2</position>
  <in_Quantity.quantity>113423.485</in_Quantity.quantity>
  <in_Quantity.quality>A04</in_Quantity.quality>
  <out_Quantity.quantity>542630.839</out_Quantity.quantity>
  <out_Quantity.quality>A04</out_Quantity.quality>
</Point>
```

All elements are mandatory and listed in the table below.

Element name	Cardinality	Content type	Description
position	Mandatory	Integer [1...2884]	The position of the quarter within the covered period

in_Quantity.quantity	Optional	Double	Value for the direction IN (if possible for the component) or the element is not present
in_Quantity.quality	Optional	Element	Quality for the direction IN (if possible for the component) or the element is not present Possible values: <ul style="list-style-type: none"> <li>• Normal : "A04"</li> <li>• Inexact: "A02"</li> <li>• Substituted: "A01"</li> </ul>
out_Quantity.quantity	Optional	Double	Value for the direction OUT (if possible for the component) or the element is not present
out_Quantity.quality	Optional	Element	Quality for the direction OUT (if possible for the component) or the element is not present Possible values: <ul style="list-style-type: none"> <li>• Normal : "A04"</li> <li>• Inexact: "A02"</li> <li>• Substituted: "A01"</li> </ul>

Table 54 XML &lt;point&gt; element for Imbalance messages

#### 4.9. XML Transfer of Energy (ToE) delivered volumes

For a general explanation and especially the concept of component, see section "2.10 Transfer of Energy (ToE) Delivered volumes " p 69

The XML Transfer of Energy (ToE) delivered volumes message has a structure which is different of the other metering messages.

The Elia goal is to replace in a near future all the Metering XML messages in order to cope with European and worldwide standards that are available now: the current Transfer of Energy (ToE) delivered volumes message respects the **IEC standard 62325-451-4**.

The XML structure is explained in this document but whole description is available on the IEC web store: <https://webstore.iec.ch/publication/29116> (document on purchase).

The Reference XML Schema (XSD) address can be found in section "4.1 Reference XSD " p 134.

```

<EnergyAccount_MarketDocument
xsi:schemaLocation="urn:iec62325.351:tc57wg16:451-4:energyaccountdocument:4:0
iec62325-451-4-settlement.xsd" xmlns="urn:iec62325.351:tc57wg16:451-
4:energyaccountdocument:4:0" xmlns:xsi="http://www.w3.org/2001/XMLSchema-
instance">

  <mRID>DPBSP_20200101_20200131</mRID>
  <revisionNumber>1</revisionNumber>
  <type>Z05</type>
  <docStatus>
    <value>A01</value>
  </docStatus>
  <process.processType>Z03</process.processType>
  <process.classificationType>A01</process.classificationType>
  <sender_MarketParticipant.mRID
codingScheme="A01">10X1001A1001A094</sender_MarketParticipant.mRID>

```



```

<sender_MarketParticipant.marketRole.type>
  A04</sender_MarketParticipant.marketRole.type>
<receiver_MarketParticipant.mRID codingScheme="A01">
  22X20131122----9</receiver_MarketParticipant.mRID>
<receiver_MarketParticipant.marketRole.type>
  R12</receiver_MarketParticipant.marketRole.type>
<createdDateTime>2020-12-29T17:49:12Z</createdDateTime>
<period.timeInterval>
  <start>2020-07-31T22:00Z</start>
  <end>2020-08-31T22:00Z</end>
</period.timeInterval>
<domain.mRID codingScheme="A01">10YBE-----2</domain.mRID>

```

#### 4.9.1. XML Transfer of Energy (ToE) delivered volumes Header fields

The following header fields are mandatory and are listed in the table below.

Element name	Content type	Description
mRID	String [1..35]	The unique identification of the document. Any implementation should only refer to this mRID to determine if this message instance was already treated or not.
revisionNumber	Integer [1..999]	The version number of the document: It is not guaranteed that first document received by the BRP has version number 1. A more recent document has a higher version number
type	String [3]	Fixed. Always Z05 (DP to BSP)
docStatus	String [3]	The status of the Imbalance document. Possible values: <ul style="list-style-type: none"> <li>• A01 - Intermediate</li> <li>• A02 - Final</li> <li>• A03 - Final Modified</li> </ul>
process.processType	String [3]	<ul style="list-style-type: none"> <li>• Fixed. Always Z03</li> </ul>
process.classificationType	String [3]	The classification mechanism used to group a set of objects together within a business process. Possible values: <ul style="list-style-type: none"> <li>• A01 - Detail</li> <li>• A02 - Summary</li> </ul> Normally only A01 is part of the Imbalance message but theoretically other classificationType could also exist
sender_MarketParticipant.mRID	codingScheme: String [3] Value: String [16]	Fixed: <ul style="list-style-type: none"> <li>• codingScheme: A01 (EIC)</li> <li>• 10X1001A1001A094 (Elia EIC)</li> </ul>
sender_MarketParticipant.marketRole.type	String [3]	Fixed: Always A04 (System operator)

receiver_MarketParticipant.mRID	codingScheme: String [3] Value: String [16]	<ul style="list-style-type: none"> <li>codingScheme: Fixed A01 (EIC)</li> <li>Value : EIC code of the BSP</li> </ul>
receiver_MarketParticipant.marketRole.type	String [3]	Fixed: Always R12 (BSP)
createdDateTime	Date and time (see page 195)	Time at which the message was created (in UTC time).
period.timeInterval	Start / End: Date page 195	Covered Period: Normally this is exactly one month (in UTC time). Example for the month August 2015: Start time is 31/7/2015 at 22h. End time is 31/8/2015 at 22h Any period is theoretically possible.
Domain.mRID	codingScheme: String [3] Value: String [16]	Fixed: Always <ul style="list-style-type: none"> <li>codingScheme: A01 (EIC)</li> <li>10YBE-----2 (Belgian Area)</li> </ul>

Table 55 XML header elements for Transfer of Energy (ToE) delivered volumes messages

#### 4.9.2. XML Transfer of Energy (ToE) delivered volumes TimeSeries fields

The <TimeSeries> element contains information to characterize the Component and related data

It contains also the Period element: see

```
<mRID>Z36_541449200000555507</mRID>
<businessType>Z36</businessType>
<product>8716867000030</product>
<MeteringType>A01</MeteringType>
<CalculationMethod>A01</CalculationMethod>
<objectAggregation>A01</objectAggregation>
<area_Domain.mRID codingScheme="A10">541449200000555507</area_Domain.mRID>
<measure_Unit.name>KWT</measure_Unit.name>
<Period>
```

All elements are listed in the table below.

Element name	Content type	Description
mRID	String [1..35]	Time series unique identification within the message
businessType	String [3]	Fields identifying the characteristics of the component : See table below
product	String [1..35]	Fixed. Always 8716867000016 - Active Power
objectAggregation	String [3]	Based on the business type. See table here below
area_Domain.mRID	String [1..18]	Based on the business type. See table here below

marketParticipant.mRID	String [1..18]	Based on the table here below, is the EIC code of the Party
measure_Unit.name	String [3]	Power unit. Always KWT
Period	See "4.8.3 XML Imbalance Period fields" page 155	

Table 56 XML Time Series element for Transfer of Energy (ToE) delivered volumes messages

Component	Business Type	Flow direction	Aggregation	Party/area	Market Participant	XML Grouping
TotalToEVolumesUpInjection_DeliveredVolume_PerDeliveryDirection&MeteringDirection	Z33	In	By Party	10YBE-----2	BSP/FSP EIC	Grouped
TotalToEVolumesUpOfftake_DeliveredVolume_PerDelivery&MeteringDirection	Z33	Out	By Party	10YBE-----2	BSP/FSP EIC	
TotalToEVolumesDownInjection_DeliveredVolume_Total_PerDelivery&MeteringDirection	Z34	In	By Party	10YBE-----2	BSP/FSP EIC	Grouped
TotalToEVolumesDownOfftake_DeliveredVolume_PerDeliveryDirection&MeteringDirection	Z34	Out	By Party	10YBE-----2	BSP/FSP EIC	
ToEVolumesUpInjection_DeliveredVolumeperDeliveryPoint_PerDelivery&MeteringDirection	Z35	In	By Area	Delivery Point EAN	Not used	Grouped
ToEVolumesUpOfftake_DeliveredVolumeperDeliveryPoint_PerDelivery&MeteringDirection	Z35	Out	By Area	Delivery Point EAN	Not used	
ToEVolumesDownInjection_DeliveredVolumeperDeliveryPoint_PerDelivery&MeteringDirection	Z36	In	By Area	Delivery Point EAN	Not used	Grouped
ToEVolumesDownOfftake_DeliveredVolumeperDeliveryPoint_PerDelivery&MeteringDirection	Z36	Out	By Area	Delivery Point EAN	Not used	

Table 57 XML Time Series Business ID element possible values and related data for Transfer of Energy (ToE) delivered volumes message

#### 4.9.3. XML Transfer of Energy (ToE) delivered volumes Period fields

The <Period> element contains information to characterize the power value and quality for a period

It contains also the Period element: see

```

<Period>
  <timeInterval>
    <start>2015-07-31T22:00Z</start>
    <end>2015-08-30T22:00Z</end>
  </timeInterval>
  <resolution>PT15M</resolution>
</Point>

```

All elements are mandatory and listed in the table below.

Element name	Content type	Description
period.timeInterval	Start / End: Date page 195	Covered Period: Normally this is exactly one month in ISO 8601 format (see section "4.17 Data types "page195 ").
resolution	String	Total number of minutes in the schedule. (! See also section 6.5, page 74 on the effect of daylight saving.)
Point	See below	

Table 58 XML Time Series period and related data for Transfer of Energy (ToE) delivered volumes message

#### 4.9.4. XML Transfer of Energy (ToE) delivered volumes Point fields

The <Point> element contains information to characterize the power value and quality for a period

```

<Point>
  <position>2</position>
  <in_Quantity.quantity>113423.485</in_Quantity.quantity>
  <in_Quantity.quality>A04</in_Quantity.quality>
  <out_Quantity.quantity>542630.839</out_Quantity.quantity>
  <out_Quantity.quality>A04</out_Quantity.quality>
</Point>

```

All elements are listed in the table below.

Element name	Cardinality	Content type	Description
position	Mandatory	Integer [1...2884]	The position of the quarter within the covered period
in_Quantity.quantity	Optional	Double	Value for the direction IN (if possible for the component) or the element is not present
in_Quantity.quality	Optional	Element	Quality for the direction IN (if possible for the component) or the element is not present Possible values: <ul style="list-style-type: none"> <li>• Normal : "A04"</li> <li>• Inexact: "A02"</li> <li>• Substituted: "A01"</li> </ul>

out_Quantity.quantity	Optional	Double	Value for the direction OUT (if possible for the component) or the element is not present
out_Quantity.quality	Optional	Element	Quality for the direction OUT (if possible for the component) or the element is not present Possible values: <ul style="list-style-type: none"><li>• Normal : "A04"</li><li>• Inexact: "A02"</li><li>• Substituted: "A01"</li></ul>

Table 59 XML <point> element for Transfer of Energy (ToE) delivered volumes messages

## 4.10. XML Real-Time DGO Allocation Estimation

The XML Real-Time DGO Allocation message is very similar to the XML Imbalance Message (see "4.8 XML Imbalance messages" on page 150). In particular, the XML Real-Time DGO Allocation is sent in the same way as the Imbalance components. In this way, if there are evolutions towards sending other imbalance components in real-time, these will require minor changes to the message.

The Elia goal is to replace in a near future all the Metering XML messages in order to cope with European and worldwide standards that are available now: the current Imbalance message respects the **IEC standard 62325-451-4**

The XML structure is explained in this document but whole description is available on the IEC web store: <https://webstore.iec.ch/publication/29116> (document on purchase)

```
<?xml version="1.0" encoding="iso-8859-1" standalone="yes"?>
<EnergyAccount_MarketDocument
xsi:schemaLocation="urn:iec62325.351:tc57wg16:451-4:energyaccountdocument:4:0
iec62325-451-4-settlement_v4.xsd" xmlns="urn:iec62325.351:tc57wg16:451-
4:energyaccountdocument:4:0" xmlns:xsi="http://www.w3.org/2001/XMLSchema-
instance">

    <mRID>IMB_20150801_20150831</mRID>

    <revisionNumber>10</revisionNumber>

    <type>A12type>

    <docStatus><value>A02</value></docStatus>

    <process.processType>A06</process.processType>

    <process.classificationType>A01</process.classificationType>

    <sender_MarketParticipant.mRID
codingScheme="A01">10X1001A1001A094</sender_MarketParticipant.mRID>

    <sender_MarketParticipant.marketRole.type>A04</sender_MarketParticipan
t.marketRole.type>

    <receiver_MarketParticipant.mRID codingScheme="A01">22XBRPA-----A
</receiver_MarketParticipant.mRID>

    <receiver_MarketParticipant.marketRole.type>A08</receiver_MarketPartic
ipant.marketRole.type>

    <createdDateTime>2015-09-14T22:00:00Z</createdDateTime>

    <period.timeInterval><start>2015-07-31T22:00Z</start><end>2015-08-
31T22:00Z</end></period.timeInterval>

    <domain.mRID codingScheme="A01">10YBE-----2</domain.mRID>

    <TimeSeries>
```

### 4.10.1. XML Real-Time DGO Allocation Estimation Header fields

The following header fields are mandatory and are listed in the table below.

Element name	Content type	Description
mRID	String [1..35]	The unique identification of the document. Currently: "IMB_[First day of the period covered:YYYYMMDD]_[Last day of the covered period:YYYYMMDD]" Example: IMB_20150801_20150831
revisionNumber	Integer [1...999]	The version number of the document: It is not guaranteed that first document received by the BRP has version number 1. A more

		recent document has a higher version number
type	String [3]	Fixed. Always A12 (Imbalance document)
docStatus	String [3]	The status of the Real-Time DGO Allocation Estimation document. Possible values: <ul style="list-style-type: none"> <li>• A01 - Intermediate</li> </ul> Note that no other values are possible, the Real-Time DGO Allocation does not follow any validation process.
process.processType	String [3]	The type of the Imbalance document. Possible values: <ul style="list-style-type: none"> <li>• A99 – Real-Time DGO Allocation Estimation (see )</li> </ul>
process.classificationType	String [3]	The classification mechanism used to group a set of objects together within a business process. Possible values: <ul style="list-style-type: none"> <li>• A01 - Detail</li> <li>• A02 - Summary</li> </ul> Normally only A01 is part of the Imbalance message but theoretically other classificationType could also exist
sender_MarketParticipant.mRID	codingScheme: String [3] Value: String [16]	Fixed: <ul style="list-style-type: none"> <li>• codingScheme: A01 (EIC code)</li> <li>• 10X1001A1001A094 (Elia EIC code)</li> </ul>
sender_MarketParticipant.marketRole.type	String [3]	Fixed: Always A04 (System operator)
receiver_MarketParticipant.mRID	codingScheme: String [3] Value: String [16]	<ul style="list-style-type: none"> <li>• codingScheme: Fixed A01 (EIC code)</li> <li>• Value : EIC code of the BRP</li> </ul>
receiver_MarketParticipant.marketRole.type	String [3]	Fixed: Always A08 (Balance responsible party / BRP)
createdDateTime	Date and time (see page 195)	Time at which the message was created (in UTC time).
period.timeInterval	Start / End: Date page 195	Covered Period: Normally this is exactly one month (in UTC time). Example for the month August 2015: Start time is 31/7/2015 at 22h. End time is 31/8/2015 at 22h Any period is theoretically possible.
Domain.mRID	codingScheme: String [3] Value: String [16]	Fixed: <ul style="list-style-type: none"> <li>• codingScheme: A01 (EIC code)</li> <li>• 10YBE-----2 (Belgian Area)</li> </ul>

Table 60 XML header elements for Imbalance messages

#### 4.10.2. XML Real-Time DGO Allocation Estimation TimeSeries fields

The <TimeSeries> element contains information to characterize the Component and related data  
It contains also the Period element see "4.10.3 XML Real-Time DGO Allocation Estimation Period fields" on page 164.

```
<TimeSeries>
<mRID>A03-22XBRPA-----A</mRID>
<businessType>A03</businessType>
<product>8716867000016</product><objectAggregation>A03</objectAggregation>
<area_Domain.mRID codingScheme="A01">10YBE-----2</area_Domain.mRID>
<marketParticipant.mRID codingScheme="A01">22XBRPA-----A
</marketParticipant.mRID>
<measure_Unit.name>KWT</measure_Unit.name>
<Period>
```

All elements are listed in the table below.

Element name	Content type	Description
mRID	String [1..35]	Time series unique identification within the message
businessType	String [3]	Fields identifying the characteristics of the component : See table below
product	String [1..35]	Fixed. Always 8716867000030 - Active Energy
objectAggregation	String [3]	Fixed. Always A03
area_Domain.mRID	String [1..18]	Based on the table here below, can be an EAN or EIC code of the Area
marketParticipant.mRID	String [1..18]	Based on the table here below, is the EIC code of the Party
measure_Unit.name	String [3]	Power unit. Always KWT
Period	See "4.10.3 XML Real-Time DGO Allocation Estimation Period fields" on page 164	

Table 61 XML <data> element for Imbalance messages

Component	Business Type	Flow direction	Aggregation	Grouping in Time series
RT DGO Allocation Estimate	Z22	Net-In		
RT DGO Allocation Estimate Quality	Z23	N/A		

Table 62 XML Time Series component and related data

#### 4.10.3. XML Real-Time DGO Allocation Estimation Period fields

The <Period> element contains information to characterize the power value and quality for a period

```
<Period>
<timeInterval>
```



```

<start>2015-07-31T22:00Z</start>
<end>2015-08-30T22:00Z</end>
</timeInterval>
<resolution>PT15M</resolution>
<Point>

```

All elements are mandatory and listed in the table below.

Element name	Content type	Description
period.timeInterval	Start / End: Date page 195	Covered Period: Normally this is exactly one month in ISO 8601 format (see section "4.17 Data types "page195 ).
resolution	String	Total number of minutes in the schedule. (! See also section 6.5, page 74 on the effect of daylight saving.)
Point	See below	

Table 63 XML Period elements and related data

#### 4.10.4. XML Real-Time DGO Allocation Estimation Point fields

The <Point> element contains information to characterize the power value and quality for a period. Note that flow is only given in one direction (in\_quantity) but that negative values are allowed (see "2.11 Real-Time DGO Allocation" on page 75.)

```

<Point>
  <position>2</position>
  <in_Quantity.quantity>113423.485</in_Quantity.quantity>
  <in_Quantity.quality>A04</in_Quantity.quality>
</Point>

```

All elements are mandatory and listed in the table below.

Element name	Cardinality	Content type	Description
position	Mandatory	Integer [1...2884]	The position of the quarter within the covered period
in_Quantity.quantity	Optional	Double	Value for the direction IN (if possible for the component) or the element is not present
in_Quantity.quality	Optional	Element	Quality for the direction IN (if possible for the component) or the element is not present Possible values: <ul style="list-style-type: none"> <li>• Normal : "A04"</li> <li>• Inexact: "A02"</li> <li>• Substituted: "A01"</li> </ul>

Table 64 XML Point element for Imbalance messages

#### 4.11. XML DGO Border Point and Supply Bay (DGOBP) message

These messages provide metering values for all the power transferred from Elia across a distribution supply bay within a substation. DGO Border Point and Supply Bay messages are regulated messages. For a general explanation of the content of these messages see section 2.12.

The XML Border Point and Supply message provide the metering values for Border Points but also for the Supply Bay below a Border Point.

The information in this section provides details on the fields and their possible values for use in the implementation of client applications.

The XML Border Point and Supply message has a structure which is different of the other metering messages. The Elia goal is to replace in a near future all the Metering XML messages in order to cope with European and worldwide standards that are available now: the current Imbalance message respects the **IEC standard 62325-451-4**

The XML structure is explained in this document but whole description is available on the IEC web store: <https://webstore.iec.ch/publication/29116> (document on purchase)

```
<EnergyAccount_MarketDocument
xsi:schemaLocation="urn:iec62325.351:tc57wg16:451-4:energyaccountdocument:4:0
iec62325-451-4-settlement_v4.xsd" xmlns="urn:iec62325.351:tc57wg16:451-
4:energyaccountdocument:4:0" xmlns:xsi="http://www.w3.org/2001/XMLSchema-
instance">
</EnergyAccount_MarketDocument>
```

##### 4.11.1. XML DGOBP Header fields

The following header fields are mandatory and are listed in the table below.

Element name	Content type	Description
mRID	String [1..35]	The unique identification of the document.
revisionNumber	Integer [1..999]	The version number of the document: It is not guaranteed that first document received has version number 1. A more recent document has a higher version number
type	String [3]	Fixed. Always A45 (Measurement Value document)
docStatus	String [3]	The status of the DGOBP document. Possible values: <ul style="list-style-type: none"> <li>• A01 - Intermediate</li> <li>• A02 - Final</li> <li>• A03 - Final Modified</li> </ul>
process.processType	String [3]	Fixed. Always A16 (Realized)
process.classificationType	String [3]	The classification mechanism used to group a set of objects together within a business process. Possible values: <ul style="list-style-type: none"> <li>• A01 - Detail</li> <li>• A02 - Summary</li> </ul> Normally only A01 is part of the DGOBP but theoretically other classificationType could also exist
sender_MarketParticipant.mRID	codingScheme: String [3] Value: String [16]	Fixed: <ul style="list-style-type: none"> <li>• codingScheme: A01 (EIC code)</li> <li>• 10X1001A1001A094 (Elia EIC code)</li> </ul>

sender_MarketParticipant.marketRole.type	String [3]	Fixed: Always A04 (System operator)
receiver_MarketParticipant.mRID	codingScheme: String [3] Value: String [16]	<ul style="list-style-type: none"> <li>codingScheme: Fixed A01 (EIC code)</li> <li>Value : EIC code of the receiver</li> </ul>
receiver_MarketParticipant.marketRole.type	String [3]	Possible values: <ul style="list-style-type: none"> <li>R02 – MRCO or CMS</li> <li>R06 - DGO</li> </ul>
createdDateTime	Date and time (see page 195)	Time at which the message was created (in UTC time).
period.timeInterval	Start / End: Date page 195	Covered Period: Normally this is exactly one month (in UTC time). Example for the month August 2015: Start time is 31/7/2015 at 22h. End time is 31/8/2015 at 22h Any period is theoretically possible.
Domain.mRID	codingScheme: String [3] Value: String [16]	<ul style="list-style-type: none"> <li>codingScheme: A10 (EAN code)</li> <li>BorderPoint EAN code</li> </ul>

Table 65 XML headers elements for DGOBP messages

#### 4.11.2. XML DGOBP TimeSeries fields

The <TimeSeries> element contains information to characterize the Component and related data  
 It contains also the Period element: see "4.11.3 XML DGOBP Period fields " p 169 .

```

<TimeSeries>
  <mRID>A65|541453104512600409</mRID>
  <businessType>A65</businessType>
  <product>8716867000016</product>
  <MeteringType>A01</MeteringType>
  <CalculationMethod>A01</CalculationMethod>
  <objectAggregation>A01</objectAggregation>
  <area_Domain.mRID codingScheme="A10">541453104512600409</area_Domain.mRID>
  <measure_Unit.name>KWT</measure_Unit.name>
  <Period>...</Period>
</TimeSeries>
  
```

All elements are listed in the table below.

Element name	Content type	Description
mRID	String [1..35]	Time series unique identification within the message
businessType	String [3]	Fields identifying the characteristics of the component defined in "2.12.3.1 DGO

		Border Point and Supply Bay components"page80 : See table below
product	String [1..35]	<ul style="list-style-type: none"> <li>8716867000016 - Active Energy</li> <li>8716867000115 - Capacitive Reactive energy</li> <li>8716867000122 - Inductive Reactive energy</li> </ul>
Calculation Method	String [3]	<ul style="list-style-type: none"> <li>A01- Compensated</li> <li>A02- NonCompensated</li> </ul>
Metering Type	String [3]	Fixed. Always A01 - Net
objectAggregation	String [3]	Fixed. Always A01
area_Domain.mRID	String [1..18]	The Border Point EAN or the Supply Bay EAN, depending on the business type
marketParticipant.mRID	String [1..18]	Not Used
measure_Unit.name	String [3]	Power unit. <ul style="list-style-type: none"> <li>KWT for Active Energy</li> <li>KVR for Inductive and Capacitive Energy</li> </ul>
Period	Similar to "4.8.3 XML Imbalance Period fields "page155	

Table 66 XML &lt;data&gt; element for DGOBP messages

Component	Business Type	Flow direction
Border Point Injection	A65 – Accounting Point Relevant	Out
Border Point Offtake	A65 – Accounting Point Relevant	In
Supply Bay Injection	A64 – Meter Measurement Data	Out
Supply Bay Offtake	A64 – Meter Measurement Data	In

Table 67 XML DGOBP Time Series component and related data

For instance, the timeseries for a border point will have business type A65 and those of a supply bay will have type A64.

```

<TimeSeries>
  <mRID>A65|541453104512600461</mRID>
  <businessType>A65</businessType> <!--Border Point -->
  <product>8716867000016</product>
  <!-- Active power -->
  <MeteringType>A01</MeteringType>
  <!-- Net -->
  <CalculationMethod>A01</CalculationMethod>
  <!-- Compensated -->
  <objectAggregation>A01</objectAggregation>
  <area_Domain.mRID
codingScheme="A10">541453104512600461</area_Domain.mRID>

```

```

        <measure_Unit.name>KWT</measure_Unit.name>
        <Period>...</Period>
    </TimeSeries>
    <TimeSeries>
        <mRID>A64_541453104512600447</mRID>
        <businessType>A64</businessType>
        <!-- Supply Bay -->
        <product>8716867000016</product>
        <!-- Active power -->
        <MeteringType>A01</MeteringType>
        <!-- Net -->
        <CalculationMethod>A01</CalculationMethod>
        <!-- Compensated -->
        <objectAggregation>A01</objectAggregation>
        <area_Domain.mRID
codingScheme="A10">541453104512600447</area_Domain.mRID>
        <measure_Unit.name>KWT</measure_Unit.name>
        <Period>...</Period>
    </TimeSeries>

```

#### 4.11.3. XML DGOBP Period fields

The <Period> element contains information to characterize the power value and quality for a period

It contains also the Period element: see

```

    <Period>
        <timeInterval>
            <start>2015-07-31T22:00Z</start>
            <end>2015-08-30T22:00Z</end>
        </timeInterval>
        <resolution>PT15M</resolution>
        <Point>

```

All elements are mandatory and listed in the table below.

Element name	Content type	Description
period.timeInterval	Start / End: Date page 195	Covered Period: Normally this is exactly one month in ISO 8601 format (see section "4.17 Data types "page195 ).
resolution	String	Total number of minutes in the schedule. (! See also section 6.5, page 74 on the effect of daylight saving.)
Point	See below	

Table 68 XML Time Series <Period> component for DGOBP messages

#### 4.11.4. XML DGOBP Point fields

The <Point> element contains information to characterize the power value and quality for a period

```
<Point>  
  <position>1</position>  
  <in_Quantity.quantity>336507.529</in_Quantity.quantity>  
  <in_Quantity.quality>A04</in_Quantity.quality>  
  <out_Quantity.quantity>0</out_Quantity.quantity>  
  <out_Quantity.quality>A04</out_Quantity.quality>  
</Point>
```

All elements are listed in the table below.

Element name	Cardinality	Content type	Description
position	Mandatory	Integer [1...2884]	The position of the quarter within the covered period
in_Quantity.quantity	Optional	Double	Value for the direction IN (if possible for the component) or the element is not present
in_Quantity.quality	Optional	Element	Quality for the direction IN (if possible for the component) or the element is not present Possible values: <ul style="list-style-type: none"> <li>• Normal : "A04"</li> <li>• Inexact: "A02"</li> <li>• Substituted: "A01"</li> </ul>
out_Quantity.quantity	Optional	Double	Value for the direction OUT (if possible for the component) or the element is not present
out_Quantity.quality	Optional	Element	Quality for the direction OUT (if possible for the component) or the element is not present Possible values: <ul style="list-style-type: none"> <li>• Normal : "A04"</li> <li>• Inexact: "A02"</li> <li>• Substituted: "A01"</li> </ul>

Table 69 XML Point element for DGOBP messages

## 4.12. XML DeltaTS message

The purpose of these messages is to provide the difference between the energy measured by Elia at a Border Point (4.1) and the sum of the energy reported by DGO at the DGO Interconnection Points (4.2) linked to the border Point.

The message provides:

- The energy flow measured by Elia at the DGO Border Point (4.1)
- The energy measured by each DGO at the DGO Interconnection Point (4.2)
- The difference between the components above (4.1 –  $\Sigma$ 4.2). This difference is called "Delta TS" and is actually a kind of "clearing differences".

The Delta TS message is a regulated message. For a general explanation of the content of these messages see section "2.13 Delta TS report" p 84 .

The XML Delta TS message provides the metering values for Border Points but also for the DGO Interconnection Points linked to a Border Point.

The information in this section provides details on the fields and their possible values for use in the implementation of client applications.

The XML Delta TS message has a structure which is different of the other metering messages. The Elia goal is to replace in a near future all the Metering XML messages in order to cope with European and worldwide standards that are available now: the current Imbalance message respects the **IEC standard 62325-451-4**

The XML structure is explained in this document but whole description is available on the IEC web store: <https://webstore.iec.ch/publication/29116> (document on purchase)

```
<EnergyAccount_MarketDocument
xsi:schemaLocation="urn:iec62325.351:tc57wg16:451-4:energyaccountdocument:4:0
iec62325-451-4-settlement_v4.xsd" xmlns="urn:iec62325.351:tc57wg16:451-
4:energyaccountdocument:4:0" xmlns:xsi="http://www.w3.org/2001/XMLSchema-
instance">

</EnergyAccount_MarketDocument>
```

### 4.12.1. XML Delta TS <header>

The following header fields are mandatory and are listed in the table below.

Element name	Content type	Description
mRID	String [1..35]	The unique identification of the document.
revisionNumber	Integer [1...999]	The version number of the document: It is not guaranteed that first document received has version number 1. A more recent document has a higher version number
type	String [3]	Fixed. Always Z02 – (Infeed Control)
docStatus	String [3]	The status of the Delta TS document. Possible values: <ul style="list-style-type: none"> <li>• A01 - Intermediate</li> <li>• A02 - Final</li> <li>• A03 – Final Modified</li> </ul>
process.processType	String [3]	Possible values: <ul style="list-style-type: none"> <li>• A05 - Metered data aggregation</li> </ul>
process.classification Type	String [3]	The classification mechanism used to group a set of objects together within a business process. Possible values:



		<ul style="list-style-type: none"> <li>• A01 - Detail</li> <li>• A02 - Summary</li> </ul> <p>Normally only A01 is part of the Delta TS but theoretically other classificationType could also exist</p>
sender_MarketParticipant.mRID	codingScheme: String [3] Value: String [16]	<p>Fixed:</p> <ul style="list-style-type: none"> <li>• codingScheme: A01 (EIC code)</li> <li>• 10X1001A1001A094 (Elia EIC code)</li> </ul>
sender_MarketParticipant.marketRole.type	String [3]	Fixed: Always A04 (System operator)
receiver_MarketParticipant.mRID	codingScheme: String [3] Value: String [16]	<ul style="list-style-type: none"> <li>• codingScheme: Fixed A01 (EIC code)</li> <li>• Value : EIC code of the receiver</li> </ul>
receiver_MarketParticipant.marketRole.type	String [3]	<ul style="list-style-type: none"> <li>• Fixed: Always R02 (MRCO)</li> <li>•</li> </ul>
createdDateTime	Date and time (see page 195)	Time at which the message was created (in UTC time).
period.timeInterval	Start / End: Date page 195	<p>Covered Period: Normally this is exactly one month (in UTC time). Example for the month August 2015: Start time is 31/7/2015 at 22h. End time is 31/8/2015 at 22h</p> <p>Any period is theoretically possible.</p>
Domain.mRID	codingScheme: String [3] Value: String [16]	<ul style="list-style-type: none"> <li>• codingScheme: A10 (EAN code)</li> <li>• BorderPoint EAN code</li> </ul>

Table 70 XML headers elements for Delta TS messages

#### 4.12.2. XML Delta TS TimeSeries fields

The <TimeSeries> element contains information to characterize the Component and related data. It contains also the Period element: see "see "4.8.3 XML Imbalance Period fields" page 155.

```

<TimeSeries>
  <mRID>Z01|541453104512600515</mRID>
  <businessType>Z01</businessType>
  <!--=Clearing Difference-->
  <product>8716867000016</product>
  <!-- Active power -->
  <MeteringType>A01</MeteringType>
  <!-- Net -->
  <CalculationMethod>A01</CalculationMethod>
  <!-- Compensated -->
  <objectAggregation>A01</objectAggregation>

```

```

        <area_Domain.mRID
codingScheme="A10">541453104512600515</area_Domain.mRID>
        <measure_Unit.name>KWT</measure_Unit.name>
        <Period>...</Period>

</TimeSeries>

```

All elements are listed in the table below.

Element name	Content type	Description
mRID	String [1..35]	Time series unique identification within the message
businessType	String [3]	Fields identifying the characteristics of the component defined in "2.13.3.1 DeltaTS Components" page84 : See table below
product	String [1..35]	Fixed. Always 8716867000016 - Active Power
Calculation Method	String [3]	Fixed. Always A01- Compensated
Metering Type	String [3]	Fixed. Always A01 - Net
objectAggregation	String [3]	Fixed. Always A01
area_Domain.mRID	String [1..18]	The Border Point EAN or the DGO Interconnection Point Offtake/Injection EAN, depending on the business type
marketParticipant.mRID	String [1..18]	Not Used
measure_Unit.name	String [3]	Power unit. Fixed. Always KWT
Period	Similar to "4.8.3 XML Imbalance Period fields "page155	

Table 71 XML <data> element for DeltaTS messages

Component	Business Type	Flow direction
Border Point Injection	A65 – Accounting Point Relevant	Out
Border Point Offtake	A65 – Accounting Point Relevant	In
DGO Interconnection Point Injection	A66 – Energy Flow	In
DGO Interconnection Point Offtake	A66 – Energy Flow	Out
DeltaTS	Z01 – Clearing Difference	In

Table 72 XML DeltaTS component and related data

For instance, the timeseries for a border point will have business type A65; those of a DGO Interconnection Point will have type A66 and the DeltaTS will have type Z01

```

<TimeSeries>
  <mRID>Z04_541453104512600409</mRID>
  <businessType>Z01</businessType>

```

```

<!--Clearing Difference-->
<product>8716867000016</product>
<!-- Active power -->
<MeteringType>A01</MeteringType>
<!-- Net -->
<CalculationMethod>A01</CalculationMethod>
<!-- Compensated -->
<objectAggregation>A01</objectAggregation>
<area_Domain.mRID
codingScheme="A10">541453104512600409</area_Domain.mRID>
<measure_Unit.name>KWT</measure_Unit.name>
<Period>..</Period>
<TimeSeries>
<mRID>A65_541416004540000143</mRID>
<businessType>A65</businessType>
<!--Accounting Point-->
<product>8716867000016</product>
<!-- Active power -->
<MeteringType>A01</MeteringType>
<!-- Net -->
<CalculationMethod>A01</CalculationMethod>
<!-- Compensated -->
<objectAggregation>A01</objectAggregation>
<area_Domain.mRID
codingScheme="A10">541416004540000143</area_Domain.mRID>
<measure_Unit.name>KWT</measure_Unit.name>
<Period>..</Period>
</TimeSeries>
<TimeSeries>
<mRID>166_541453104512600423</mRID>
<businessType>A66</businessType>
<!--Energy power-->
<product>8716867000016</product>
<!-- Active power -->
<MeteringType>A01</MeteringType>
<!-- Net -->
<CalculationMethod>A01</CalculationMethod>
<!-- Compensated -->
<objectAggregation>A01</objectAggregation>
<area_Domain.mRID
codingScheme="A10">541453104512600423</area_Domain.mRID>
<marketParticipant.mRID codingScheme="A01">22XDGOB-----
-6</marketParticipant.mRID>
<!-- Associated DGO -->
<measure_Unit.name>KWT</measure_Unit.name>

```

```
<Period>...</Period>
```

#### 4.12.3. XML Delta TS Point fields

The <Point> element contains information to characterize the power value and quality for a period

```
<Point>
    <position>1</position>

    <in_Quantity.quantity>336507.529</in_Quantity.quantity>

    <in_Quantity.quality>A04</in_Quantity.quality>

    <out_Quantity.quantity>0</out_Quantity.quantity>

    <out_Quantity.quality>A04</out_Quantity.quality>
</Point>
```

All elements are mandatory and listed in the table below.

Element name	Cardinality	Content type	Description
position	Mandatory	Integer [1...2884]	The position of the quarter within the covered period
in_Quantity.quantity	Optional	Double	Value for the direction IN (if possible for the component) or the element is not present
in_Quantity.quality	Optional	Element	Quality for the direction IN (if possible for the component) or the element is not present Possible values: <ul style="list-style-type: none"> <li>• Normal : "A04"</li> <li>• Inexact: "A02"</li> <li>• Substituted: "A01"</li> </ul>
out_Quantity.quantity	Optional	Double	Value for the direction OUT (if possible for the component) or the element is not present
out_Quantity.quality	Optional	Element	Quality for the direction OUT (if possible for the component) or the element is not present Possible values: <ul style="list-style-type: none"> <li>• Normal : "A04"</li> <li>• Inexact: "A02"</li> <li>• Substituted: "A01"</li> </ul>

Table 73 XML <point> element for Delta TS messages

### 4.13. XML Delta DGO Exchanges (DGO2DGO) message

The purpose of these messages is to provide the difference between the energy measured by each of the DGO in a given DGO exchange point (DGO2DGO) for the CMS.

The message provides:

- The energy flow measured by each of the DGO for a given DGO exchange point (DGO2DGO)
- The difference between the energy measured by each of the DGO for a given DGO exchange point (DGO2DGO). This difference is called "Delta DGO Exchanges (DGO2DGO)" and is actually a kind of "clearing difference".

The Delta DGO Exchanges message is a regulated message. For a general explanation of the content of these messages see section 2.14.

The information in this section provides details on the fields and their possible values for use in the implementation of client applications.

The XML Delta DGO Exchanges (DGO2DGO) message has a structure which is different of the other metering messages. The Elia goal is to replace in a near future all the Metering XML messages in order to cope with European and worldwide standards that are available now: the current Imbalance message respects the **IEC standard 62325-451-4**

The XML structure is explained in this document but whole description is available on the IEC web store: <https://webstore.iec.ch/publication/29116> (document on purchase)

```
<EnergyAccount_MarketDocument
xsi:schemaLocation="urn:iec62325.351:tc57wg16:451-4:energyaccountdocument:4:0
iec62325-451-4-settlement_v4.xsd" xmlns="urn:iec62325.351:tc57wg16:451-
4:energyaccountdocument:4:0" xmlns:xsi="http://www.w3.org/2001/XMLSchema-
instance">

</EnergyAccount_MarketDocument>
```

#### 4.13.1. XML Delta DGO Exchanges (DGO2DGO) Header fields

The following header fields are mandatory and are listed in the table below.

Element name	Content type	Description
mRID	String [1..35]	The unique identification of the document. Example: <mRID>FDBACD7A1EC14398A1CE6163BCD1B8A5</mRID>
revisionNumber	Integer [1...999]	The version number of the document: It is not guaranteed that first document received has version number 1. A more recent document has a higher version number
type	String [3]	Fixed. Always Z03 – (Clearing Difference)
docStatus	String [3]	The status of the Imbalance document. Possible values: <ul style="list-style-type: none"> <li>• A01 - Intermediate</li> <li>• A02 - Final</li> <li>• A03 – Final Modified</li> </ul>
process.processType	String [3]	Fixed. Always A05 (Metered Data Aggregation)
process.classification Type	String [3]	The classification mechanism used to group a set of objects together within a business process. Possible values: <ul style="list-style-type: none"> <li>• A01 - Detail</li> <li>• A02 - Summary</li> </ul>

		Normally only A01 is part of the DGO2DGO but theoretically other classificationType could also exist
sender_MarketParticipant.mRID	codingScheme: String [3] Value: String [16]	Fixed: <ul style="list-style-type: none"> <li>codingScheme: A01 (EIC code)</li> <li>10X1001A1001A094 (Elia EIC code)</li> </ul>
sender_MarketParticipant.marketRole.type	String [3]	Fixed: Always A04 (System operator)
receiver_MarketParticipant.mRID	codingScheme: String [3] Value: String [16]	<ul style="list-style-type: none"> <li>codingScheme: Fixed A01 (EIC code)</li> <li>Value : EIC code of the receiver</li> </ul>
receiver_MarketParticipant.marketRole.type	String [3]	<ul style="list-style-type: none"> <li>Always : R02 – MRCO (CMS)</li> </ul>
createdDateTime	Date and time (see page 195)	Time at which the message was created (in UTC time).
period.timeInterval	Start / End: Date page 195	Covered Period: Normally this is exactly one month (in UTC time). Example for the month August 2015: Start time is 31/7/2015 at 22h. End time is 31/8/2015 at 22h Any period is theoretically possible.
Domain.mRID	codingScheme: String [3] Value: String [16]	<ul style="list-style-type: none"> <li>codingScheme: MIX</li> <li>Value: Concatenation of DGO A GLN and DGO B GLN, with a "-" in between</li> <li>Example: <code>&lt;domain.mRID codingScheme="MIX"&gt;5414490000900-5499842496501&lt;/domain.mRID&gt;</code></li> </ul>

Table 74 XML headers elements for Delta DGO Exchanges (DGO2DGO) messages

#### 4.13.2. XML Delta DGO Exchanges (DGO2DGO) TimeSeries fields

The <TimeSeries> element contains information to characterize the Component and related data  
It contains also the Period element: see "4.8.3 XML Imbalance Period fields" page 155.

```

<TimeSeries>
<mRID>Z01_5115340470003-5115340477804</mRID>
<businessType>Z01</businessType>
<!--=Clearing Difference-->
<product>8716867000030</product><!-- Active Energy -->
<MeteringType>A01</MeteringType>
<!-- Net -->
<CalculationMethod>A01</CalculationMethod>
<!-- Compensated -->
<objectAggregation>A03</objectAggregation>
<area_Domain.mRID codingScheme="A10">5115340470003</area_Domain.mRID>
<marketParticipant.mRID codingScheme="A10">5115340477804</marketParticipant.mRID>

```

```
<measure_Unit.name>KWT</measure_Unit.name>
<Period>...</Period>
</TimeSeries>
```

All elements are listed in the table below.

Element name	Content type	Description
mRID	String [1..35]	Time series unique identification within the message
businessType	String [3]	Fields identifying the characteristics of the component defined in "2.14.3.1 Delta DGO Exchanges (DGO2DGO) Components" p 89 : See table here below
product	String [1..35]	Fixed. Always 8716867000016 - Active Power
Calculation Method	String [3]	Fixed Always A01- Compensated
Metering Type	String [3]	Fixed. Always A01 - Net
objectAggregation	String [3]	Fixed. Always A01
area_Domain.mRID	String [1..18]	The GLN code of the DGO reporting the data
marketParticipant.mRID	String [1..18]	The GLN code of the DGO with which the exchange is made
measure_Unit.name	String [3]	Power unit. KWT for Active Energy KVR for Reactive Energy
Period	Similar to "4.8.3XML Imbalance Period fields "page 155	

Table 75 XML <data> element for Delta DGO Exchanges (DGO2DGO) messages

Component	Business Type	Flow direction
DGOExchange	A02 – Internal Trade	Out and In
Delta DGOExchange	Z01 – Clearing Difference	In

Table 76 XML Delta DGO Exchanges (DGO2DGO) component and related data

For instance, the timeseries for a DGO Exchange will have business type A02 and the Delta DGOExchange will have type Z01

```
<TimeSeries>
  <mRID>Z01_GLN DGO A-GLN DGO B</mRID>
  <businessType>Z01</businessType>
  <!--=Clearing Difference-->
  <product>8716867000016</product><!-- Active power -->
  <MeteringType>A01</MeteringType>
  <!-- Net -->
  <CalculationMethod>A01</CalculationMethod>
```

```

        <!-- Compensated -->
        <objectAggregation>A03</objectAggregation>
        <area_Domain.mRID codingScheme="A10">GLN DGO
A</area_Domain.mRID>
        <marketParticipant.mRID codingScheme="A10">GLN DGO
B</marketParticipant.mRID>
        <measure_Unit.name>KWT</measure_Unit.name>
        <Period>...</Period>
    </TimeSeries>
    <TimeSeries>
        <mRID>A02_GLN DGO A-GLN DGO B</mRID>
        <businessType>A02</businessType>
        <!-- Internal Trade -->
        <product>8716867000016</product>
        <!-- Active power -->
        <MeteringType>A01</MeteringType>
        <!-- Net -->
        <CalculationMethod>A02</CalculationMethod>
        <!-- NonCompensated -->
        <objectAggregation>A03</objectAggregation>
        <area_Domain.mRID codingScheme="A10">GLN DGO
A</area_Domain.mRID>
        <marketParticipant.mRID codingScheme="A10">GLN DGO
B</marketParticipant.mRID>
        <measure_Unit.name>KWT</measure_Unit.name>
        <Period>...</Period>
    <!-- Exchange between DGO A and DGO B reported by DGO A -->

    </TimeSeries>
    <TimeSeries>
        <mRID>A02_GLN DGO B-GLN DGO A</mRID>
        <businessType>A02</businessType>
        <!-- Internal Trade -->
        <product>8716867000016</product>
        <!-- Active power -->
        <MeteringType>A01</MeteringType>
        <!-- Net -->
        <CalculationMethod>A02</CalculationMethod>
        <!-- NonCompensated -->
        <objectAggregation>A03</objectAggregation>
        <area_Domain.mRID codingScheme="A10">GLN DGO
B</area_Domain.mRID>
        <marketParticipant.mRID codingScheme="A10">GLN DGO
A</marketParticipant.mRID>
        <measure_Unit.name>KWT</measure_Unit.name>

```



```

    <Period>...</Period>
    <!-- Exchange between DGO A and DGO B reported by DGO B -->
  </TimeSeries>

```

#### 4.13.3. XML Delta DGO Exchanges (DGO2DGO) Point fields

The <Point> element contains information to characterize the power value and quality for a period

```

<Point>
  <position>1</position>
  <in_Quantity.quantity>336507.529</in_Quantity.quantity>
  <in_Quantity.quality>A04</in_Quantity.quality>
  <out_Quantity.quantity>0</out_Quantity.quantity>
  <out_Quantity.quality>A04</out_Quantity.quality>
</Point>

```

All elements are mandatory and listed in the table below.

Element name	Cardinality	Content type	Description
position	Mandatory	Integer [1...2884]	The position of the quarter within the covered period
in_Quantity.quantity	Optional	Double	Value for the direction IN (if possible for the component) or the element is not present
in_Quantity.quality	Optional	Element	Quality for the direction IN (if possible for the component) or the element is not present Possible values: <ul style="list-style-type: none"> <li>• Normal : "A04"</li> <li>• Inexact: "A02"</li> <li>• Substituted: "A01"</li> </ul>
out_Quantity.quantity	Optional	Double	Value for the direction OUT (if possible for the component) or the element is not present
out_Quantity.quality	Optional	Element	Quality for the direction OUT (if possible for the component) or the element is not present Possible values: <ul style="list-style-type: none"> <li>• Normal : "A04"</li> <li>• Inexact: "A02"</li> <li>• Substituted: "A01"</li> </ul>

Table 77 XML <point> element for Delta DGO Exchanges (DGO2DGO) messages

#### 4.14. XML DGO Loop Losses (DGO PBO) messages

For a general explanation and especially the concept of component in the DGO Loop Losses (DGO PBO) message, see section "2.15 DGO Loop Losses (DGO PBO) report" page 93.

The XML DGO Loop Losses (DGO PBO) message has a structure which is different of the "Classic" metering messages but similar to the XML Imbalance message.

The Elia goal is to replace in a near future all the Metering XML messages in order to cope with European and worldwide standards that are available now: the current DGO Loop Losses (DGO PBO) message respects the **IEC standard 62325-451-4**

The XML structure is explained in this document but whole description is available on the IEC web store: <https://webstore.iec.ch/publication/29116> (document on purchase)

```

<EnergyAccount_MarketDocument
xsi:schemaLocation="urn:iec62325.351:tc57wg16:451-4:energyaccountdocument:4:0
ELIA-iec62325-451-4-settlement.xsd" xmlns="urn:iec62325.351:tc57wg16:451-
4:energyaccountdocument:4:0" xmlns:xsi="http://www.w3.org/2001/XMLSchema-
instance">

    <mRID>EE2C5627CD6143B2BEF774F93AF128F7</mRID>

    <revisionNumber>1</revisionNumber>

    <type>Z01<!--LoopLosses-->
</type>

    <docStatus>
        <value>A01</value>
        <!--Intermediate-->
    </docStatus>

    <process.processType>A05</process.processType>
    <!--Metered data aggregation-->
    <process.classificationType>A01</process.classificationType>
    <!--Detail-->

    <sender_MarketParticipant.mRID
codingScheme="A01">10X1001A1001A094</sender_MarketParticipant.mRID>
    <sender_MarketParticipant.marketRole.type>A04</sender_MarketPar
ticipant.marketRole.type>

    <receiver_MarketParticipant.mRID codingScheme="A01">22XDGOB----
----6</receiver_MarketParticipant.mRID>
    <receiver_MarketParticipant.marketRole.type>R06</receiver_Marke
tParticipant.marketRole.type>

    <!--R06-->

    <createdDateTime>2016-04-07T22:00:00Z</createdDateTime>

    <period.timeInterval>
        <start>2015-07-31T22:00Z</start>
        <end>2015-08-01T22:00Z</end>
    </period.timeInterval>

    <domain.mRID
codingScheme="A10">541453104512600461</domain.mRID>
    <!--domain = associated information-->

```

*Example 84 Example of DGO Loop losses ( DGO PBO) message*

#### 4.14.1. XML DGO Loop Losses (DGO PBO) Header fields

The following header fields are mandatory and are listed in the table below.

Element name	Content type	Description
mRID	String [1..35]	The unique identification of the document.
revisionNumber	Integer [1...999]	The version number of the document: A more recent document has a higher version number. It is not guaranteed that first document received by the Recipient has version number 1.
type	String [3]	Fixed. Always Z01 (PBO document)
docStatus	String [3]	The status of the PBO document. Possible values: <ul style="list-style-type: none"> <li>• A01 - Intermediate : used for non-validated messages</li> <li>• A02 - Final : used for validated message</li> <li>• A03 - Final Modified</li> </ul> See "1.2.8 Regulated messages & message delivery frequency "page19
process.processType	String [3]	The type of the PBO document. Possible values: <ul style="list-style-type: none"> <li>• A05 - Metered data aggregation</li> </ul>
process.classificationType	String [3]	The classification mechanism used to group a set of objects together within a business process. Possible values: <ul style="list-style-type: none"> <li>• A01 - Detail</li> <li>• A02 - Summary</li> </ul> Normally only A01 is used within the DGO Loop losses ( DGO PBO) message but theoretically other classificationType could also exist
sender_MarketParticipant.mRID	codingScheme: String [3] Value: String [16]	Fixed: <ul style="list-style-type: none"> <li>• codingScheme: A01 (EIC code)</li> <li>• 10X1001A1001A094 (Elia EIC code)</li> </ul>
sender_MarketParticipant.marketRole.type	String [3]	Fixed: Always A04 (System operator)
receiver_MarketParticipant.mRID	codingScheme: String [3] Value: String [16]	<ul style="list-style-type: none"> <li>• codingScheme: Fixed A01 (EIC code)</li> <li>• Value : EIC code of the DGO or MRCO</li> </ul>
receiver_MarketParticipant.marketRole.type	String [3]	<ul style="list-style-type: none"> <li>• Fixed: Always R02 (MRCO)</li> <li>•</li> </ul>
createdDateTime	Date and time (see page 195)	Time at which the message was created (in UTC time).
period.timeInterval	Start / End: Date page 195	Covered Period: Normally this is exactly one month (in UTC time). Example for the month August 2015: Start time is 31/7/2015 at 22h. End time is 31/8/2015 at 22h However any period is theoretically possible.

Domain.mRID	codingScheme: String [3] Value: String [16]	<ul style="list-style-type: none"> <li>codingScheme: A10 (EAN code)</li> <li>DGO Network EAN</li> </ul>
-------------	--	---

Table 78 XML headers elements for DGO Loop losses (DGO PBO) messages

#### 4.14.2. XML DGO Loop Losses (DGO PBO) TimeSeries fields

The <TimeSeries> element contains information to characterize the Component and related data. It contains also the Period element, see: "4.8.3 XML Imbalance Period fields" page 155.

```

<TimeSeries>
  <mRID>A66_541453104512600461</mRID>
  <businessType>A66</businessType>
  <!--=Power flow-->
  <product>8716867000016</product>
  <!-- Active power -->
  <objectAggregation>A01</objectAggregation>
  <area_Domain.mRID
codingScheme="A10">541453104512600461</area_Domain.mRID>
  <measure_Unit.name>KWT</measure_Unit.name>
  <Period>...</Period>
</TimeSeries>

```

Example 85 PBO Time Series element

All elements are mandatory and listed in the table below.

Element name	Content type	Description
mRID	String [1..35]	Time series unique identification within the current message
businessType	String [3]	Fields identifying the characteristics of the component defined in "2.15.3.1 DGO Loop Losses (DGO PBO) components" page 94 : See table below
product	String [1..35]	Fixed. Always 8716867000016 - Active Power
objectAggregation	String [3]	Fixed. Always A01
area_Domain.mRID	String [1..18]	The EAN code of the DGO Network
marketParticipant.mRID	String [1..18]	Currently not used
measure_Unit.name	String [3]	Power unit. Always KWT
Period	See "4.14.3 XML DGO Loop Losses (DGO PBO) Period fields " p 185	

Table 79 XML &lt;data&gt; element for DGO Loop Losses (DGO PBO) messages

Component	Business Type	Flow direction
DGOLoopLosses	Z01 - Clearing Difference	In

DGOInfeedOfftakeTotal and DGOInfeedInjectionTotal	A66 - Energy flow	Out and In
DGOAllocationOfftakeTotal and DGOAllocationInjectionTotal	A14 - Aggregated energy data	Out and In
DGOExchangeOfftakeTotal and DGOExchangeInjectionTotal	A02 - Internal Trade	In and Out

Table 80 XML DGO Loop Losses (DGO PBO) Time Series component and related data

#### 4.14.3. XML DGO Loop Losses (DGO PBO) Period fields

The <Period> element contains information to characterize the power value and quality for a period.

```

<Period>
  <timeInterval>
    <start>2015-07-31T22:00Z</start>
    <end>2015-08-30T22:00Z</end>
  </timeInterval>
  <resolution>PT15M</resolution>
  <Point>

```

All elements are mandatory and listed in the table below.

Element name	Content type	Description
period.timeInterval	Start / End: Date page 195	Covered Period: Normally this is exactly one month in ISO 8601 format (see section "4.17 Data types "page195 ).
resolution	String	Total number of minutes in the schedule. (! See also section 6.5, page 74 on the effect of daylight saving.)
Point	See below	

Table 81 XML Time Series component and related data for DGO Loop Losses message

#### 4.14.4. XML DGO Loop Losses (DGO PBO) Point fields

The <Point> element contains information to characterize the power value and quality for a position.

```

<Point>
  <position>2</position>
  <in_Quantity.quantity>113423.485</in_Quantity.quantity>
  <in_Quantity.quality>A04</in_Quantity.quality>
  <out_Quantity.quantity>542630.839</out_Quantity.quantity>
  <out_Quantity.quality>A04</out_Quantity.quality>
</Point>

```

Element name	Cardinality	Content type	Description
position	Mandatory	Integer [1...2884]	The position of the quarter within the covered period

in_Quantity.quantity	Optional	Double	Value for the direction IN (if possible for the component) or the element is not present
in_Quantity.quality	Optional	Element	Quality for the direction IN (if possible for the component) or the element is not present Possible values: <ul style="list-style-type: none"> <li>• Normal : "A04"</li> <li>• Inexact: "A02"</li> <li>• Substituted: "A01"</li> </ul>
out_Quantity.quantity	Optional	Double	Value for the direction OUT (if possible for the component) or the element is not present
out_Quantity.quality	Optional	Element	Quality for the direction OUT (if possible for the component) or the element is not present Possible values: <ul style="list-style-type: none"> <li>• Normal : "A04"</li> <li>• Inexact: "A02"</li> <li>• Substituted: "A01"</li> </ul>

Table 82 XML &lt;Point&gt; element for DGO Loop losses ( DGO PBO) messages

#### 4.15. XML DGO Reactive Area and Supply Bay metering message

For a general explanation and especially the concept of component, see "2.16 DGO Reactive Area and Supply Bay " p 98

The XML DGO Reactive Area and Supply Bay metering message has a structure which is different of the other metering messages.

The Elia goal is to replace in a near future all the Metering XML messages in order to cope with European and worldwide standards that are available now: the current DGO Reactive Area and Supply Bay metering message respects the **IEC standard 62325-451-4**

The XML structure is explained in this document but whole description is available on the IEC web store: <https://webstore.iec.ch/publication/29116> (document on purchase)

```
<?xml version="1.0" encoding="iso-8859-1" standalone="yes"?>
<EnergyAccount_MarketDocument
xsi:schemaLocation="urn:iec62325.351:tc57wg16:451-4:energyaccountdocument:4:0
iec62325-451-4-settlement_v4.xsd" xmlns="urn:iec62325.351:tc57wg16:451-
4:energyaccountdocument:4:0" xmlns:xsi="http://www.w3.org/2001/XMLSchema-
instance">
    <mRID>DRA_20150801_20150831</mRID>
    <revisionNumber>10</revisionNumber>
    <type>Z07</type>
    <docStatus><value>A02</value></docStatus>
    <process.processType>A05</process.processType>
    <process.classificationType>A02</process.classificationType>
    <sender_MarketParticipant.mRID
codingScheme="A01">10X1001A1001A094</sender_MarketParticipant.mRID>
    <sender_MarketParticipant.marketRole.type>A04</sender_MarketParticipan
t.marketRole.type>
```

```

<receiver_MarketParticipant.mRID codingScheme="A01">22XDGO-
EXAMPLE3A</receiver_MarketParticipant.mRID>

<receiver_MarketParticipant.marketRole.type>
R06</receiver_MarketParticipant.marketRole.type>

<createdDateTime>2020-12-14T23:00:00Z</createdDateTime>

<period.timeInterval><start>2020-09-31T22:00Z</start><end>2020-09-
30T22:00Z</end></period.timeInterval>

<domain.mRID codingScheme="A01">10YBE-----2</domain.mRID>

<TimeSeries>

```

#### 4.15.1. XML DGO Reactive Area and Supply Bay metering Header fields

The following header fields are mandatory and are listed in the table below.

Element name	Content type	Description
mRID	String [1..35]	The unique identification of the document. Currently: "DRA_[First day of the period covered:YYYYMMDD]_[Last day of the covered period:YYYYMMDD]" Example: DRA_20150801_20150831
revisionNumber	Integer [1..999]	The version number of the document: It is not guaranteed that first document received by the DGO has version number 1. A more recent document has a higher version number
type	String [3]	Fixed. Always Z07 (Reactive Area and Supply Bay report)
docStatus	String [3]	The status of the document. Possible values: <ul style="list-style-type: none"> <li>• A01 – Intermediate (Normally never possible due to the fact that the document is always validated. However this is theoretically possible)</li> <li>• A02 – Final</li> <li>• A03 – Final Modified</li> </ul>
process.processType	String [3]	The type of the Imbalance document. Possible values: <ul style="list-style-type: none"> <li>• A05 - Metered data aggregation</li> </ul>
process.classificationType	String [3]	Fixed. Always A02 - Summary
sender_MarketParticipant.mRID	codingScheme: String [3] Value: String [16]	Fixed: <ul style="list-style-type: none"> <li>• codingScheme: A01 (EIC code)</li> <li>• 10X1001A1001A094 (Elia EIC code)</li> </ul>
sender_MarketParticipant.marketRole.type	String [3]	Fixed: Always A04 (System operator)
receiver_MarketParticipant.mRID	codingScheme: String [3]	<ul style="list-style-type: none"> <li>• codingScheme: Fixed A01 (EIC code)</li> <li>• Value : DGO EIC</li> </ul>

	Value: String [16]	
receiver_MarketParticipant.marketRole.type	String [3]	The type of the receiver. Possible values: <ul style="list-style-type: none"> <li>• R02: Metering Reading Company (MRCO)</li> <li>• R06: Distribution Grid Operator (DGO)</li> </ul>
createdDateTime	Date and time (see page 195)	Time at which the message was created (in UTC time).
period.timeInterval	Start / End: Date page 195	Covered Period: Normally this is exactly one month (in UTC time). Example for the month August 2020: Start time is 31/7/2020 at 22h. End time is 31/8/2020 at 22h Any period is theoretically possible.
Domain.mRID	codingScheme: String [3] Value: String [16]	Fixed: <ul style="list-style-type: none"> <li>• codingScheme: A01 (EIC code)</li> <li>• 10YBE-----2 (Belgian Area)</li> </ul>

Table 83 XML headers elements for DGO Reactive Area and Supply Bay metering messages

#### 4.15.2. XML DGO Reactive Area and Supply Bay metering TimeSeries fields

The <TimeSeries> element contains information to characterize the Component and related data.

Remark: there is no imposed order on the Time series of the different components

It contains also the Period element: see "4.15.3 XML DGO Reactive Area and Supply Bay metering Period fields" p 190

```

<TimeSeries>
  <mRID>1234567890123456789</mRID>
  <businessType>A03</businessType>
  <product>8716867000016</product>
  <objectAggregation>A03</objectAggregation>
  <area_Domain.mRID codingScheme="A01">10YBE-----2</area_Domain.mRID>
  <marketParticipant.mRID codingScheme="A01">22XBRPA-----A
</marketParticipant.mRID>
  <measure_Unit.name>KWT</measure_Unit.name>
  <Period>

```

All elements are listed in the table below.

Element name	Content type	Description
mRID	String [1..35]	Time series unique identification within the message



businessType	String [3]	Fields identifying the characteristics of the component : See table below
product	String [1..35]	Field identifying if this is Active, Capacitive or Inductive power. See table below. See table below
objectAggregation	String [3]	Fixed. Always A03
area_Domain.mRID	String [1..18]	The DGO Reactive Area or the Border Point. See table below
measure_Unit.name	String [3]	Power unit. Always KVR - Kilo Volt Ampere Reactive
marketEvaluationPoint.mRID	string	Only used for Supply Bay
Period	See below	

Table 84 XML <Timeseries> element for 'DGO Reactive Area and Supply Bay' metering messages

Component	Business Type	Flow direction	Aggregation	area_Domain.mRID	marketEvaluationPoint.mRID
DGOArea	A14 - Aggregated energy data	Out or In	By Area	The DGO Reactive Area name	Not present
SupplyBay	Z28 - Supply Bay	Out or In	By Area	The Border Point EAN.	The Supply Bay EAN

Table 85 XML Time Series component and related data for 'DGO Reactive Area and Supply Bay'

Power Type	XML product	Unit
Active power	8716867000016	KWT
Inductive Power	8716867000146	KVR
Capacitive power	8716867000139	KVR

Table 86 XML Time Series power type and related data for 'DGO Reactive Area and Supply Bay'

#### 4.15.3. XML DGO Reactive Area and Supply Bay metering Period fields

The <Period> element contains information to characterize the power value and quality for a period

It contains also the Period element: see

```

<Period>
  <timeInterval>
    <start>2015-07-31T22:00Z</start>
    <end>2015-08-30T22:00Z</end>
  </timeInterval>
  <resolution>PT15M</resolution>
  <Point>

```

All elements are mandatory and listed in the table below.

Element name	Content type	Description
period.timeInterval	Start / End: Date page 195	Covered Period: Exactly one month in ISO 8601 format (see section "4.17 Data types "page195 ").
resolution	String	Total number of minutes in the schedule. (! See also section 6.5, page 74 on the effect of daylight saving.) Fixed : Always "PT15M" – 15 minutes
Point	See below	

Table 87 XML Period element for DGO Reactive Area and Supply Bay message

#### 4.15.4. XML DGO Reactive Area and Supply Bay metering Point fields

The <Point> element contains information to characterize the power value and quality for a period

```

<Point>
  <position>2</position>
  <in_Quantity.quantity>113423.485</in_Quantity.quantity>
  <in_Quantity.quality>A04</in_Quantity.quality>
  <out_Quantity.quantity>542630.839</out_Quantity.quantity>
  <out_Quantity.quality>A04</out_Quantity.quality>
</Point>

```

All elements are mandatory and listed in the table below.

Element name	Cardinality	Content type	Description
position	Mandatory	Integer [1...2884]	The position of the quarter within the covered period
in_Quantity.quantity	Optional	Double	Value for the direction IN or the element is not present "IN" means from the DGO Area to the TSO ( Area
in_Quantity.quality	Optional	Element	Quality for the direction IN Possible values:

			<ul style="list-style-type: none"> <li>• Normal : "A04"</li> <li>• Inexact: "A02"</li> <li>• Substituted: "A01"</li> </ul>
out_Quantity.quantity	Optional	Double	Value for the direction OUT or the element is not present "OUT" means from the TSO(Elia) Area to the DGO Area
out_Quantity.quality	Optional	Element	Quality for the direction OUT (if possible for the component) or the element is not present Possible values: <ul style="list-style-type: none"> <li>• Normal : "A04"</li> <li>• Inexact: "A02"</li> <li>• Substituted: "A01"</li> </ul>

Table 88 XML <point> element for DGO Reactive Area and Supply Bay metering messages

## 4.16. XML elements

This section describes the XML elements that are contained within other elements. These include:

- "party" elements described on page 191.
- "point" elements described on page 192.
- "schedule" elements described on page 193.

### 4.16.1. Party elements

Party elements refer to:

- <sender> the sender of the metering message
- <receiver> the receiver of the metering message
- <partyFrom> the party from which the power is flowing
- <partyTo> the party to which the power is flowing

An example of a <sender> is shown below

```

<sender>
  <code>5499770302608</code>
  <codeType>C01</codeType>
  <friendlyName>ELIA</friendlyName>
  <role>R01</role>
</sender>

```

Example 86 XML Party elements

The contents of the party element are listed in the table below. Details on the different data types are given in section 4.17 on page 195.

Element	Cardinality	Data type	Description
<code>	mandatory	string	Party identification code
<codeType>	mandatory	string	Code type. Possible values are: <ul style="list-style-type: none"> <li>• C01: EAN code *(see note below)</li> <li>• C02: DVG code</li> <li>• C03: EIC code *(see note below)</li> <li>• C11: ELIA proprietary coding scheme</li> </ul>
<friendlyName>	optional	string	Name to easily identify the party
<role>	mandatory	string	Role of the party. Possible values are: <ul style="list-style-type: none"> <li>• R01: Transmission System Operator (TSO)</li> <li>• R02: Metering Reading Company (MRCO)</li> <li>• R03: Grid User (GU)</li> <li>• R04: Access Contract Holder (ACH)</li> <li>• R05: Access Responsible Party (BRP)</li> <li>• R06: Distribution Grid Operator (DGO)</li> <li>• R07: Supplier</li> <li>• R08: ENergy COordinator (ENCO)</li> <li>• R09: Metering Contract Holder (MCH)</li> </ul>

Table 89 XML Party element contents

\* For messages concerning MRCO and DGO, the EAN code is used. For messages concerning direct clients, the EIC code is used.

#### 4.16.2. Point elements

Point elements are used to identify access or Metering Points. An example of an Access Point description is shown below.

```

<point>
  <code>8400001000009</code>
  <codeType>C01</codeType>
  <friendlyName>accessPoint4</friendlyName>
</point>

```

The contents of the <point> element are listed in the table below. Details on the different data types are given in section 4.17 on page 195.

Element	Cardinality	Data type	Description
<code>	mandatory	string	Point identification code
<codeType>	mandatory	string	Fixed. Always C01 : EAN code
<friendlyName>	optional	string	Name to easily identify the point.

Table 90 XML Point element contents

### 4.16.3. Schedule elements

<schedule> elements contain all the fields that describe the metered data as well as the data values themselves. They occur in all message types.

An example of a <schedule> element is given below. Not all of the data values are shown.

```

<schedule>
  <beginDateTime>2001-12-31T23:00:00Z</beginDateTime>
  <duration>4320</duration>
  <period>15</period>
  <unit>W</unit>
  <powerType>A</powerType>
  <meteringType>N</meteringType>
  <compType>C</compType>
  <profile>ULP</profile>
+ <v-list>
  <v>4000.000</v>
  Etc: not all values represented in this example
  <v>2874000.000</v>
</v-list>
+ <q-list>
  <q>N</q>
  Etc: not all quality flags represented in this example
  <q>N</q>
</q-list>
<validated>false</validated>
</schedule>

```

Example 87 XML <schedule> element

The contents of the <schedule> element are listed in the table below. Details on the different data types are given in section 4.17 on page 195.

Elements	Cardinality	Data type	Description
<beginDateTime>	mandatory	Date time	Date and time of the beginning of the schedule
<duration>	mandatory	integer	Total number of minutes of the schedule. This must be a multiple of a period.
<period>	mandatory	integer	The number of minutes for each value period. This always has the value 15 minutes.
<unit>	mandatory	string	Unit in which the values are defined. These are usually units of power (see section 1.1.3.2) but can be other units for Metering Point messages.
<powerType>	optional	string	Identification of the type of power* (see section 1.1.1). Possible values are: <ul style="list-style-type: none"> <li>• A: Active</li> <li>• I: Inductive</li> <li>• C: Capacitive</li> </ul> * this has no meaning for Metering Point messages containing non-power values.

<meteringType>	Optional (default=N)	string	<p>Indication as to whether the values are net or gross* (see section 1.1.3.4). Possible values are:</p> <ul style="list-style-type: none"> <li>• N: Net</li> <li>• G: Gross</li> </ul> <p>* this has no meaning for Metering Point messages containing non-power values. ** FOR DGOs and MRCOs only Net is used.</p>
<compType>	Optional (default=NC)	string	<p>Indication as to whether the values are compensated* or not (see section 1.1.3.1). Possible values are:</p> <ul style="list-style-type: none"> <li>• NC: Non-Compensated. Used for metering purposes.</li> <li>• C: Compensated. Used for billing purposes</li> </ul> <p>* this has no meaning for Metering Point messages containing non-power values.</p>
<profile>	Optional (default=ULP)	string	<p>Indication of the load profile. This is field is only for information purposes and is ignored by the Metering Application.</p>
<v>	0 <= n	list of decimal	<p>Value of the transferred power. The value is always positive. The value is expressed in the defined unit and contains a maximum of 3 digits after the decimal point.</p> <p>The number of values = duration/period.</p>
<q>	0 <= n	list of string	<p>Indication as to the quality of the metered data (see also section 1.1.3.3). Possible values are:</p> <ul style="list-style-type: none"> <li>• N: Normal</li> <li>• I: Inexact</li> <li>• S: Substituted (Estimated replacement).</li> </ul> <p>Number of values must be =duration/period.</p>
<validated>	mandatory	boolean	<p>Indication as to whether the values are valid or not (see also section 1.2.3). Possible values are:</p> <ul style="list-style-type: none"> <li>• True: validated by Elia</li> <li>• False: not validated by Elia</li> </ul>

Table 91 XML Schedule element contents

## 4.17. Data types

The following table describes all the data types allowed in XML data structure specifications.

Data type	Typical XML representation	Lexical pattern	Comments
string		.*	The following constraints can be expressed: minimum length, maximum length, pattern, choice of valid values
int	-1, 0, 126789675 +100000	[ <b>-+</b> ]?[0-9] <b>+</b>	The following constraints can be expressed: minimum value, maximum value. Values must be between 2147483647 and -2147483648 inclusive.
decimal	-1.23, 12678967.543 233, +100000.00, 210	[ <b>-+</b> ]?[0-9] <b>+</b> (\.[0-9] <b>+</b> ) <b>?</b>	The following constraints can be expressed: minimum value, maximum value. Values must have at most 28 digits.
boolean	1, 0, true, false	1 0 true false	
code		.*	This is similar to string, but allowed values must be part of a documented "code table". The actual signification of the code table constraint is application-dependent.
datetime	1999-05-31T13:20:00+02:00	[0-9]{4}-[0-9]{2}-[0-9]{2}T[0-9]{2}:[0-9]{2}:[0-9]{2}([+-][0-9]{2}:[0-9]{2}) <b>?</b> <b>?</b>	Represents a time instant. If the time zone offset is not indicated, UTC is assumed. See section 6.5.2 on time formatting and daylight saving time handling.
time	13:20:00+02:00	[0-9]{2}:[0-9]{2}:[0-9]{2}([+-][0-9]{2}:[0-9]{2}) <b>?</b> <b>?</b>	Represents a time instant in the day. If the time zone offset is not indicated, UTC is assumed. See section 6.5.2 on time formatting and daylight saving time handling.
date	1999-05-31	[0-9]{4}-[0-9]{2}-[0-9]{2}	Represents a calendar date. See section 6.5.2 on time formatting and daylight saving time handling.
binary		Encoded binary data (the default encoding is base64)	Used to transfer data that is not unicode text.



Table 92 Data types in XML formatted messages

## Chapter 5 Excel (XLSX) format messages

This chapter describes in detail the content of Excel format messages.

This information is for the operational person wishing to read immediately his metering messages (via the "EVMSB2C" web page for example)

Elia does **not** recommend automating the reading of the XLSX format: Elia proposes two other formats (CSV or XML) that are targeted to IT development.

	Only Excel format 2010 ("XLSX") is supported. Previous formats ("97") are not supported
	Day light saving time When implementing business applications using metered data, you should take account of day-light saving issues as explained in section 6.5.2 on page 246.

In terms of Elia metering messages, an Excel file is:

- an Excel file containing one or two sheets (depending on the message)
- The first lines contains the header
- Next, a list of columns whose meterable description and values.

### 5.1. Excel Access Point messages

This message concerns the metering data related to a specific Access Point. Access Point messages are regulated messages. For a general explanation of the content of these messages see section 2.1.

An example of Excel format Access Point message is shown below. This example contains four metering columns each referring to different types of metering at one Access Point.

	A	B	C	D	E	F	G	H	I	J	K
1	Company	22XXXXXXXXXXXXC		Test company							
2	Meterable	541453167414516216		Access Point test							
3	Last Update	23-04-2014									
4	Validation Status	Non validated by Elia									
5											
6	Meterable type			Outgoing Active Gross		Outgoing Active Net		Incoming Active Gross		Incoming Active Net	
7				Compensated	Quality	Compensated	Quality	Compensated	Quality	Compensated	Quality
8				0 KWh	Invalid	0 KWh	Invalid	0 KWh	Invalid	0 KWh	Invalid
9	Monthly energy										
10											
11	Quarter hourly values										
12	Date	From	To	W		W		W		W	
13											
14	01-01-2015	00:00	00:15	0	I	0	I	0	I	0	I
15	01-01-2015	00:15	00:30	0	I	0	I	0	I	0	I
16	01-01-2015	00:30	00:45	0	I	0	I	0	I	0	I
17	01-01-2015	00:45	01:00	0	I	0	I	0	I	0	I
18	01-01-2015	01:00	01:15	0	I	0	I	0	I	0	I
19	01-01-2015	01:15	01:30	0	I	0	I	0	I	0	I
20	01-01-2015	01:30	01:45	0	I	0	I	0	I	0	I
21	01-01-2015	01:45	02:00	0	I	0	I	0	I	0	I
22	01-01-2015	02:00	02:15	0	I	0	I	0	I	0	I
23	01-01-2015	02:15	02:30	0	I	0	I	0	I	0	I
24	01-01-2015	02:30	02:45	0	I	0	I	0	I	0	I
25	01-01-2015	02:45	03:00	0	I	0	I	0	I	0	I
26	01-01-2015	03:00	03:15	0	I	0	I	0	I	0	I
27	01-01-2015	03:15	03:30	0	I	0	I	0	I	0	I
28	01-01-2015	03:30	03:45	0	I	0	I	0	I	0	I

Figure 16 Sheet in a CSV Access Point message



### 5.1.1. Message structure

The Access Point Excel sheet consists of the following sections:

- A header section.
- A set of columns headers.
- A set of columns values.

#### 5.1.1.1. Header

The header contains reference of the Access Point and the receiver.

	A	B	C	D
1	Company	22XXXXXXXXXXXXXC		Test company
2	Meterable	541453167414516216		Access Point test
3	Last Update	23-04-2014		
4	Validation Status	Non validated by Elia		

Figure 17 Access Point message header

Excel Cell	Name	Data type	Comment
B1:C1 (merged cells)	Receiver identification code	String	EIC company code of the receiver of the message.
D1:F1 (merged cells)	Receiver name	String	Name of the company receiver of the message. Note this is a "display name" that can be different from the official name of the company
B2:C2 (merged cells)	Access Point identification code	String	EAN (18-digit) code of the Access Point at which the data is metered.
D2:F2 (merged cells)	Access Point name	String	Name of the Access Point at which the data is metered
B3:C3 (merged cells)	Last update date	Date and time	Date and time of the creation of the highest version of this document.
B4:C4 (merged cells)	Validation	String	Indication as to whether the values are valid or not (see section 1.2.3). Possible values : <ul style="list-style-type: none"> <li>• "validated by Elia"</li> <li>• "Non-validated by Elia"</li> </ul>

Table 93 Excel Access Point header fields

#### 5.1.1.2. Columns header

From the 4<sup>th</sup> column, 2 columns identify the source of each metering data metered at the Access Point

An Excel sheet can contain 1 or more set of columns.

For one column (example Column 4):

	A	B	C	D
6	Meterable type			Outgoing
7				Active
8				Gross
9				Compensated

Figure 18 CSV Access Point message – columns header

The content of the header is listed in the table below:

Line	Name	Data type	Comment
6	Direction of transfer	String	Identification of the direction of flow (see section 1.1.2). Possible values are: "Incoming": Production of active energy (flow from client to Elia) "Outgoing": Consumption of active energy (flow from Elia to client)
7	Power type	String	Identification of the type of power (see section 1.1.1). Possible values are: <ul style="list-style-type: none"> <li>Active</li> <li>Inductive</li> <li>Capacitive</li> </ul>
8	Metering type	String	Indication as to whether the values are net or gross or specific (see section 1.1.3.4). Possible values are: <ul style="list-style-type: none"> <li>N: Net</li> <li>G: Gross</li> <li>GG: "Green Gross"</li> <li>GC: "Gross CIPU"</li> </ul>
9	Compensation type	String	Indication as to whether the values compensated or not (see section 1.1.3.1). Possible values are: <ul style="list-style-type: none"> <li>NC: Non-Compensated. Used for metering purposes.</li> <li>C: Compensated. Used for billing purposes</li> <li>A: Reserved for future use</li> <li>CC: Compensated Corrected Used for specific purposes</li> </ul>
10	Sum of the monthly energy		Excel formula = the sum of all quarter hourly values and related unit
13	Power unit	String	Unit in which the power values are defined. Possible values are: <ul style="list-style-type: none"> <li>KWT, KVR,</li> <li>W, KW, MW,</li> <li>VAR, KVAR, MVAR</li> </ul>

Table 94 Excel Access Point column metering reference

### 5.1.1.3. Columns values

The same columns (starting from the 4<sup>th</sup> column), contain the metering values and their quality (on the next column) All the quarter hourly values of the month are present

Only positive power values are allowed in the Access Point message.

Column	Name	Data type	Comment
4, 6, 8, 10, 12, etc.	Value	Unsigned Decimal	Value of the transferred power for the given quarter. The value is always positive. The value is expressed in the defined unit and contains a maximum of 3 digits after the decimal point. If there is no decimal, then no decimal point
5, 7, 9, 11, 13, etc.	Quality	1 char	Indication as to the quality of the metered data for the given quarter (see section 1.1.3.3). Possible values are: <ul style="list-style-type: none"> <li>• N: Normal</li> <li>• I: Inexact</li> <li>• S: Substituted (Estimated replacement).</li> </ul>

Table 95 Excel Access Point columns cells

Remark: The decimal point, in Excel, being subject to the settings, it can be different from the figure shown in this document

## 5.2. Excel Metering Point messages

For a general explanation of the content of these messages see section "2.3 Metering Point " p 29. An example of a Metering Point message is shown below.

	A	B	C	D	E	F
1	<b>Company</b>	22XXXXXXXXXXXXC		<b>Test company</b>		
2	<b>Meterable</b>	541453138157290220		<b>test Metering point</b>		
3	<b>Last Update</b>	23-04-2014				
4	<b>Validation Status</b>	Non validated by Elia				
5						
6	<b>Meterable type</b>			<b>Incoming</b>		
7				Active		
8				Net		
9				Alternative	Quality	
10	<b>Monthly energy</b>			0 KWh	Invalid	
11						
12	<b>Quarter hourly values</b>					
13	<b>Date</b>	<b>From</b>	<b>To</b>	<b>W</b>		
14	01-01-2015	00:00	00:15	0	I	
15	01-01-2015	00:15	00:30	0	I	
16	01-01-2015	00:30	00:45	0	I	
17	01-01-2015	00:45	01:00	0	I	
18	01-01-2015	01:00	01:15	0	I	
19	01-01-2015	01:15	01:30	0	I	
20	01-01-2015	01:30	01:45	0	I	
21	01-01-2015	01:45	02:00	0	I	
22	01-01-2015	02:00	02:15	0	I	
23	01-01-2015	02:15	02:30	0	I	
24	01-01-2015	02:30	02:45	0	I	

Figure 19 Fields in an Excel Metering Point message

### 5.2.1. Message structure

The Metering Point message consists of the following sections:

- A header.
- A set of columns headers.
- A set of columns values.

#### 5.2.1.1. Header

The header contains reference of the Metering data and the receiver.

The information is the same as the Access Point described on page 197

#### 5.2.1.2. Column headers

Same as the Access Point described on page 197

#### 5.2.1.3. Column values

Same as the Access Point described on page 199

## 5.3. Excel CDS Loop Losses (PBO) messages

CDS Loop Losses (PBO) messages contain metering data about each CDS Loop Losses (PBO) component (and related criteria's) for a BRP. For a general description see "2.5.2 Accessing CDS Loop Losses (PBO) Message " p 38

	A	B	C	D	E
1	Company	22XCDSOPERATOR.4		CDS Operator Company	
2	Meterable	541416004540000143		CDS Test1	
3	Last Update	23-11-2015		PBO	
4	Status	Final			
5	Version	10			
6					
7	Component Meterable type			CDSTotalInfeedOfftake	
8				IN	
9				Active	
10				Value	Quality
11	Monthly energy			516.064 KWh	Valid
12	Quarter hourly values				
13	Date	From	To	W	
14	01-07-2015	00:00	00:15	521.914	N
15	01-07-2015	00:15	00:30	514.735	N
16	01-07-2015	00:30	00:45	500.378	N
17	01-07-2015	00:45	01:00	494.607	N
18	01-07-2015	01:00	01:15	490.948	N
19	01-07-2015	01:15	01:30	491.089	N
20	01-07-2015	01:30	01:45	502.490	N

Figure 20 Fields in an Excel CDS Loop Losses (PBO) message

### 5.3.1. Message structure

The PBO metering message consists of the following sections:

- A header.
- A set of columns headers.
- A set of columns values.

### 5.3.1.1. header

The header contains reference of the BRP and the state, version.

	A	B	C	D	E
1	Company	22XCDSOPERATOR-4		CDS Operator Company	
2	Meterable	541416004540000143		CDS Test1	
3	Last Update	23-11-2015		PBO	
4	Status	Final			
5	Version	10			

Figure 21 Excel CDS Loop Losses (PBO) message - header

Excel Cell	Name	Data type	Comment
B1:C1 (merged cells)	Receiver identification code	String	EIC company code of the receiver of the message.
D1:F1 (merged cells)	Receiver name	String	Name of the company receiver of the message. Note this is a "display name" that can be different from the official name of the company
B2:C2 (merged cells)	Meterable EAN	String	The EAN of the CDS Access Point
D2:F2 (merged cells)	Meterable name	String	The name of the CDS Access Point
B3:C3 (merged cells)	Last update date	Date and time	Date and time of the creation of the highest version of this document.
D3:F3 (merged cells)	Message type	String	Fixed : "PBO"
B4:C4 (merged cells)	Message status	String	Indicate if the message is 'Final' or 'Intermediate' See "1.2.8 Regulated messages & message delivery frequency " page 19
B5:C5 (merged cells)	version	Integer [1..999]	The version of the message: An integer within range [1...999]. <b>Note:</b> The first message sent is not guaranteed to have version 1.

Table 96 Excel CDS Loop Losses (PBO) message - header fields

### 5.3.1.2. Columns header

From the 4<sup>th</sup> column, a set of 2 columns identifies the source of each metering data for one component

An Excel sheet can contain many sets of columns.

For one column (example Column 4 and 5):

6					
7	<b>Component Meterable type</b>			<b>CDS</b> TotalInfeedOfftake	
8				IN	
9				Active	
10				Value	Quality
11	Monthly energy			516.064 KWh	Valid
12	Quarter hourly values				
13	Date	From	To	W	

Figure 22 Excel CDS Loop Losses (PBO)message –columns header

Line	Name	Data type	Comment	
7	Component	String	One of the possible components. See "2.5.3.1 CDS Loop Losses (PBO) components " p 38	
8	Direction	String	Identification of the direction of flow Possible values are: <ul style="list-style-type: none"> <li>Outgoing</li> <li>Incoming</li> </ul>	
9	Energy type	String	Fixed = "Active"	
10	Titles	Strings	even column	odd column
			Fixed : "Value"	Fixed : "Quality"
11	Totals	Formula and string	even column	odd column
			The sum of all values in this column divided by 4	Possible value: <ul style="list-style-type: none"> <li>Valid: if all quality flags are valid</li> <li>Invalid if at least one quality flag is Inexact</li> </ul>
13	Power unit	String	Unit in which the power values are defined. Possible value: W	

Table 97 Excel CDS Loop Losses (PBO) message - column metering reference

**5.3.1.3. Columns values**

The same columns (starting from the 4<sup>th</sup> column), contain the metering values and their quality (on the next column) All the quarter hourly values of the month are present

Column	Name	Data type	Comment
4, 6, 8, 10, 12, etc.	Value	Signed Decimal	Value of the transferred power for the given quarter. The value is expressed in the defined unit and contains a maximum of 3 digits after the decimal point. In case of negative value the sign '-' is added

5, 7, 9, 11, 13, etc.	Quality	1 char	Indication as to the quality of the metered data for the given quarter (see section 1.1.3.3). Possible values are: <ul style="list-style-type: none"> <li>• N: Normal</li> <li>• I: Inexact</li> <li>• S: Substituted (Estimated replacement).</li> </ul>
-----------------------	---------	--------	---

Table 98 Excel CDS Loop Losses (PBO) message - [schedule] fields

### 5.4. Excel Infeed TSO per substation messages

This type of message is delivered to Distribution Grid Operators and Meter Reading Companies. These messages provide metering values for all the power transferred from Elia across a distribution point associated with a substation. Each distribution point can have a number of Access Points associated with it that are managed by different clients. Infeed TSO per substation messages are regulated messages. For a general explanation of the content of these messages see section 0.

An example of a message for 1 distribution point for a single power type (I = Inductive) is shown below.

	A	B	C	D	E	F	G	H	I
1	Company	22XXXXXXXXXXXXC		Test company					
2	Meterable	541453113100397584		HANNU 15					
3	Last Update	23-04-2014							
4	Validation Status	Non validated by Elia							
5	Associated Access Points	541453117400759455							
6									
7	Meterable type			Outgoing Active Net		Outgoing Capacitive Net		Outgoing Inductive Net	
8				Compensated	Quality	Compensated	Quality	Compensated	Quality
9									
10	Monthly energy			0 KWh	Invalid	0 KVARh	Invalid	0 KVARh	Invalid
11									
12	Quarter hourly values					VAR		VAR	
13		Date	From	To	W				
14		01-01-2015	00:00	00:15	0	I	0	I	0
15		01-01-2015	00:15	00:30	0	I	0	I	0
16		01-01-2015	00:30	00:45	0	I	0	I	0
17		01-01-2015	00:45	01:00	0	I	0	I	0
18		01-01-2015	01:00	01:15	0	I	0	I	0
19		01-01-2015	01:15	01:30	0	I	0	I	0
20		01-01-2015	01:30	01:45	0	I	0	I	0
21		01-01-2015	01:45	02:00	0	I	0	I	0
22		01-01-2015	02:00	02:15	0	I	0	I	0
23		01-01-2015	02:15	02:30	0	I	0	I	0
24		01-01-2015	02:30		0	I	0	I	0

Figure 23 Fields in a Excel Infeed TSO per substation message

#### 5.4.1. Message structure

The Infeed TSO per substation message consists of the following sections:

- A header section.
- A set of columns headers.
- A set of columns values.

##### 5.4.1.1. Header

The header contains reference of the distribution point and the receiver.

	A	B	C	D
1	Company	22XXXXXXXXXXXXC		Test company
2	Meterable	541453113100397584		HANNU 15
3	Last Update	23-04-2014		
4	Validation Status	Non validated by Elia		
5	Associated Access Points	541453117400759455		

Figure 24 Excel Infeed TSO per substation message-header

Excel Cell	Name	Data type	Comment
B1:C1	Receiver identification code	String	EIC company code of the receiver of the message.
D1:F1	Receiver name	String	Name of the company receiver of the message. <b>Note:</b> this is a "display name" that can be different from the official name of the company
B2:C2	Distribution point identification code	String	EAN (18-digit) code of the distribution Point at which the data is metered.
D2:F2	Distribution point name	String	Name of the Point at which the data is metered Note this is a "display name" that can be different from the official name of the Access Point
B3:C3	Last update date	Date and time	Date and time of the creation of this document.
B4:C4	Validation	String	Indication as to whether the values are valid or not (see section 1.2.3). Possible values are: <ul style="list-style-type: none"> <li>• "validated by Elia"</li> <li>• "Non-validated by Elia"</li> </ul>
B5:C5 and next columns	Associated Access Point identification code	String	EAN (18-digit) codes of the Associated Access Points

Table 99 Excel Infeed TSO per substation header fields

#### 5.4.1.2. Column headers

Same as the Access Point described on page 197

#### 5.4.1.3. Column values

Same as the Access Point described on page 199



## 5.5. Excel Infeed TSO per substation and per supply bay messages

This type of message is delivered to Distribution Grid Operators and Meter Reading Companies. These messages provide metering values for all the power transferred from Elia across a supply bay within a substation. Infeed TSO per substation and per supply bay messages are “regulated” messages. For a general explanation of the content of these messages see section 2.7.

An example of a message for 1 supply bay is shown below.

6	Meterable type			Outgoing Active Net		Outgoing Capacitive Net		Outgoing Inductive Net		Incoming Active Net		Incoming Capacitive Net		Incoming Inductive Net	
7				Compens:	Quality	Compens:	Quality	Compens:	Quality	Compens:	Quality	Compens:	Quality	Compens:	Quality
8	Non			Compens:	Quality	Compens:	Quality	Compens:	Quality	Compens:	Quality	Compens:	Quality	Compens:	Quality
9	Monthly energy			#####	Valid	#####	Valid	#####	Valid	0 KWh	Valid	0 KVARh	Valid	0 KVARh	Valid
10				#####	Valid	#####	Valid	#####	Valid	0 KWh	Valid	0 KVARh	Valid	0 KVARh	Valid
11				#####	Valid	#####	Valid	#####	Valid	0 KWh	Valid	0 KVARh	Valid	0 KVARh	Valid
12	Quarter hourly values			W		VAR		VAR		W		VAR		VAR	
13	Date	From	To	W	VAR	VAR	VAR	VAR	VAR	W	VAR	VAR	VAR	VAR	VAR
14	01-03-2014	00:00	00:15	8,158,814	N	455,738	N	0	N	0	N	0	N	0	N
15	01-03-2014	00:15	00:30	7,763,678	N	577,431	N	0	N	0	N	0	N	0	N
16	01-03-2014	00:30	00:45	7,612,905	N	577,676	N	0	N	0	N	0	N	0	N
17	01-03-2014	00:45	01:00	7,614,372	N	526,848	N	0	N	0	N	0	N	0	N
18	01-03-2014	01:00	01:15	7,506,363	N	459,648	N	0	N	0	N	0	N	0	N
19	01-03-2014	01:15	01:30	7,414,971	N	182,540	N	211,619	N	0	N	0	N	0	N
20	01-03-2014	01:30	01:45	7,344,594	N	0	N	383,895	N	0	N	0	N	0	N
21	01-03-2014	01:45	02:00	7,270,796	N	0	N	361,414	N	0	N	0	N	0	N
22	01-03-2014	02:00	02:15	7,157,656	N	0	N	384,207	N	0	N	0	N	0	N

Figure 25 Columns in a Excel Infeed TSO per substation and per supply bay message

### 5.5.1. Message structure

The Infeed TSO per substation and per supply bay message consists of the following sections:

- A header section.
- A set of columns headers.
- A set of columns values.

#### 5.5.1.1. Header

The header contains reference of the supply bay and the receiver.

The information is the same as the Access Point described on page 197

#### 5.5.1.2. Column headers

Same as the Access Point described on page 197

#### 5.5.1.3. Column values

Same as the Access Point described on page 199



D2:F2 (merged cells)	GEMPname	String	Fixed: "GEMP"
B3:C3 (merged cells)	Last update date	Date and time	Date and time of the creation of the highest version of this document.
B4:C4 (merged cells)	Validation	String	Indication as to whether the values are valid or not (see section 1.2.3). Possible values are: <ul style="list-style-type: none"> <li>• "Validated by Elia"</li> <li>• "Non-validated by Elia"</li> </ul>

Table 100 Excel GEMP header fields

### 5.6.1.2. Column headers

Same as the Access Point described on page 197

### 5.6.1.3. Column values

Same as the Access Point described on page 199

## 5.7. Excel Imbalance messages

Imbalance metering messages contain metering data about each Imbalance component (and related criteria's) for a BRP. See section "2.8 Imbalance metering".

	A	B	C	D	E	F	G	H	I
1	Company	22XBRPB-----0		BRP test					
2	Last Update	14-08-2020		Imbalance					
3	Status	Final							
4	Version	1							
5									
6		Component		CrossBorderExportTotal		DGOInjection		DGOInjection	
7		Direction		Outgoing		Incoming		Incoming	
8		Description		BRP test		Infrax West (541453199767702817)		RESA (541453199449664358)	
9				Value	Quality	Value	Quality	Value	Quality
10		Monthly energy		1,962,781 KWh	Valid	536,469 KWh	Valid	197,241 KWh	Valid
11									
12		Quarter hourly values							
13		Date From To		W		W		W	

Figure 28 Fields in an Excel Imbalance message

### 5.7.1. Message structure

The Imbalance metering message consists of the following sections:

- A header.
- A set of columns headers.
- A set of columns values.

#### 5.7.1.1. Header

The header contains reference of the BRP and the state, version.

	A	B	C	D
1	Company	22XBRPB-----0		BRP test
2	Last Update	14-08-2020		Imbalance
3	Status	Final		
4	Version	1		

Figure 29 Excel Imbalance message –header

Excel Cell	Name	Data type	Comment				
B1:C1 (merged cells)	Receiver identification code	String	EIC company code of the receiver of the message.				
D1:F1 (merged cells)	Receiver name	String	Name of the company receiver of the message. Note this is a "display name" that can be different from the official name of the company				
B2:C2 (merged cells)	Message status	Date and time	Date and time of the creation of the highest version of this document.				
D2:F2 (merged cells)	Message type	String	Fixed. Always "Imbalance"				
B3:C3 (merged cells)	Last update date	String	State of the message. Possible values: <table border="1" data-bbox="847 824 1118 1025"> <thead> <tr> <th>States</th> </tr> </thead> <tbody> <tr> <td>Intermediate</td> </tr> <tr> <td>Final</td> </tr> <tr> <td>Final Modified</td> </tr> </tbody> </table>	States	Intermediate	Final	Final Modified
States							
Intermediate							
Final							
Final Modified							
B4:C4 (merged cells)	version	Integer [1..999]	The version of the message: An integer within range [1...999]. <b>Note:</b> The first message sent is not guaranteed to have version 1.				

Table 101 Excel Access Point header fields

### 5.7.1.2. Columns header

From the 4<sup>th</sup> column, a set of 2 columns identifies the source of each metering data for one component

An Excel sheet can contain many sets of columns.

For one column (example Column 4 and 5):

	A	B	C	D	E
6	Component			CrossBorderExportTotal	
7	Direction			Outgoing	
8	Description			BRP test	
9				Value	Quality
10	Monthly energy			0 KWh	Valid
11	Quarter hourly values				
12	Date	From	To	W	
13					

Figure 30 Excel Imbalance message –columns header

Line	Name	Data type	Comment
6	Component	String	One of the possible components. See "2.9.3.1 Imbalance components "page 57
7	Direction	String	Identification of the direction of flow (see section see "2.9.3.2 Imbalance components "page 61). Possible values are: <ul style="list-style-type: none"> <li>• Outgoing (OUT): the energy is going out the BRP Balance perimeter</li> <li>• Incoming (IN): the energy is coming in the BRP balance perimeter</li> </ul>
8	Party or Area	String	The Party or Area related to the component: see " 2.9.3.3 Imbalance components added parameters " page 63
10	Sum of the monthly energy		Excel formula = the sum of all quarter hourly values and related unit
11	Power unit	String	Unit in which the power values are defined. Possible values are: - W

Table 102 Excel Imbalance column metering reference

### 5.7.1.3. Columns values

The same columns (starting from the 4<sup>th</sup> column), contain the metering values and their quality (on the next column) All the quarter hourly values of the month are present

Column	Name	Data type	Comment
4, 6, 8, 10, 12, etc.	Value	Signed Decimal	Value of the transferred power for the given quarter. The value is expressed in the defined unit and contains a maximum of 3 digits after the decimal point. In case of negative value the sign '-' is added
5, 7, 9, 11, 13, etc.	Quality	1 char	Indication as to the quality of the metered data for the given quarter (see section 1.1.3.3). Possible values are: <ul style="list-style-type: none"> <li>• N: Normal</li> <li>• I: Inexact</li> <li>• S: Substituted (Estimated replacement).</li> </ul>

Table 103 Excel Imbalance [schedule] fields

## 5.8. Excel Transfer of Energy (ToE) delivered volumes

The purpose of these messages is to provide the volumes delivered only by DP PG delivery points (former non CIPU) with a Transfer of Energy regime by a BSP/FSP in the framework of the mFRR & DA/ID service.

The Excel file is made of 2 sheets:

- The first sheet, named "Summary", contains the 'Total' components.
- The second sheet, named "Detail", contains the volumes per Delivery Point for the Bid directions Up and Down and metering directions injection and offtake.

Header is the same for all sheets.

### 5.8.1. Transfer of Energy (ToE) delivered volumes- Sheet "Summary" structure

The sheet "Summary" consists of the following sections:

- A header.
- A set of columns headers.
- A set of columns values.

#### 5.8.1.1. Transfer of Energy (ToE) delivered volumes - "Summary" header

The header contains reference of the BSP/FSP and the state, version.

	A	B	C	D	E
1	<b>Company</b>	<b>22XBSP--EXAMPLEZ</b>		<b>BSPEXample</b>	
2	<b>Last Update</b>	<b>29-12-2020</b>			
3	<b>Status</b>	<b>Intermediate</b>		<b>DPBSP</b>	
4	<b>Version</b>	<b>1</b>			

Figure 31 Transfer of Energy (ToE) delivered volumes - Excel sheet 'Summary' -header

Excel Cell	Name	Data type	Comment
B1:C1 (merged cells)	Receiver identification code	String	EIC of the BSP/FSP receiver of the message.
D1:F1 (merged cells)	Receiver name	String	Name of the BSP/FSP receiver of the message Note this is a "display name" that can be different from the official name of the company
B2:C2 (merged cells)	Last update date	Date and time	Date and time of the creation of the highest version of this document.
B3:C3 (merged cells)	Message status	String	Indicate if the message is 'Intermediate', 'Final' or 'FinalModified'
D3:F3 (merged cells)	Message type	String	Fixed. Always "DPBSP"
B4 (merged cells)	version	Integer [1..999]	The version of the message: An integer within range [1...999]. <b>Note:</b> The first message sent is not guaranteed to have version 1.

Table 104 Excel 'Transfer of Energy (ToE) delivered volumes 'header fields

#### 5.8.1.2. Transfer of Energy (ToE) delivered volumes - "Summary" Columns header

From the 4<sup>th</sup> column, a set of 2 columns identifies the source of each metering data for a 'Transfer of Energy (ToE) delivered volumes' component

This sheet can contain many sets of columns.

	A	B	C	D	E	F	G	H	I	J	K
1	Company	22XDPBSPExample		BSPEexample							
2	Last Update	11-08-2021									
3	Status	Final		DPBSP							
4	Version	3									
5											
6	Component			TotalToEVolumesUpInjection	TotalToEVolumesUpOfftake	TotalToEVolumesDownInjection	TotalToEVolumesDownOfftake				
7				DeliveredVolume	DeliveredVolume	DeliveredVolume	DeliveredVolume				
8	Party			BSPEexample	BSPEexample	BSPEexample	BSPEexample				
9				22XDPBSPExample	22XDPBSPExample	22XDPBSPExample	22XDPBSPExample				
10											
11	Meterable type			Incoming	Outgoing	Incoming	Outgoing				
12				Active	Active	Active	Active				
13				Net	Net	Net	Net				
14				Compensated	Compensated	Compensated	Compensated				
15											
16				Value	Quality	Value	Quality	Value	Quality	Value	Quality
17	Monthly energy			0 KWh	Valid	188 KWh	Valid	0 KWh	Valid	0 KWh	Valid
18											
19	Quarter hourly values										
20	Date	From	To	W	W	W	W				
21	01-04-2021	00:00	00:15	0	N	0	N	0	N	0	N
22	01-04-2021	00:15	00:30	0	N	0	N	0	N	0	N
23	01-04-2021	00:30	00:45	0	N	0	N	0	N	0	N
24	01-04-2021	00:45	01:00	0	N	0	N	0	N	0	N
25	01-04-2021	01:00	01:15	0	N	0	N	0	N	0	N
26	01-04-2021	01:15	01:30	0	N	0	N	0	N	0	N
27	01-04-2021	01:30	01:45	0	N	0	N	0	N	0	N
28	01-04-2021	01:45	02:00	0	N	0	N	0	N	0	N
29	01-04-2021	02:00	02:15	0	N	0	N	0	N	0	N
30	01-04-2021	02:15	02:30	0	N	0	N	0	N	0	N
31	01-04-2021	02:30	02:45	0	N	0	N	0	N	0	N

Figure 32 Excel 'Transfer of Energy (ToE) delivered volumes' message – Sheet 'Summary' – columns header

For one set of columns:

Line	Name	Data type	Comment
6	Component	String	See table below
7	N/A	String	Name of the BSP/FSP
8	N/A	String	EIC of the BSP/FSP
11	Meterable type	String	Metering direction
12	N/A	String	Identification of the power type Fixed. Always "Active"
13	N/A	String	Fixed. Always "Net"
14	N/A	String	Fixed. Always "Compensated"
17	monthly energy	String	Excel formula = the sum of all quarter hourly values and related unit

20	Power unit	String	Unit in which the power values are defined. Fixed. Always W
----	------------	--------	--

Table 105 Excel 'Transfer of Energy (ToE) delivered volumes' message – Sheet 'Summary' – columns references

Component	Delivery Direction	Metering Direction
TotalToEVolumesUpInjection_DeliveredVolume_PerDeliveryDirection&MeteringDirection	Delivery Up	Injection
TotalToEVolumesDownInjection_DeliveredVolume_Total_PerDelivery&MeteringDirection	Delivery Down	Injection
TotalToEVolumesUpOfftake_DeliveredVolume_PerDelivery&MeteringDirection	Delivery Up	Offtake
TotalToEVolumesDownOfftake_DeliveredVolume_PerDeliveryDirection&MeteringDirection	Delivery Down	Offtake

Table 106 Excel 'Transfer of Energy (ToE) delivered volumes' message – Sheet 'Summary' – list of components

### 5.8.1.3. Transfer of Energy (ToE) delivered volumes - "Summary" Columns values

The same columns (starting from the 4<sup>th</sup> column), contain the metering values and their quality (on the next column) All the quarter hourly values of the month are present

Column	Name	Data type	Comment
4, 6, 8, 10, 12, etc.	Value	Signed Decimal	Value of the power for the given quarter. The value is expressed in the defined unit and contains a maximum of 3 digits after the decimal point. In case of negative value the sign '-' is added
5, 7, 9, 11, 13, etc.	Quality	1 char	Indication as to the quality of the metered data for the given quarter (see section 1.1.3.3). Possible values are: <ul style="list-style-type: none"> <li>N: Normal</li> <li>I: Inexact</li> <li>S: Substituted (Estimated replacement).</li> </ul>

Table 107 Excel 'Transfer of Energy (ToE) delivered volumes' message – Sheet 'Summary' – Columns values

## 5.8.2. Transfer of Energy (ToE) delivered volumes - Sheet "Detail" structure

### 5.8.2.1. Transfer of Energy (ToE) delivered volumes - "Detail" header

The header content is the same as the one from the 'Summary' sheet. Refer to "5.8.1.1 Transfer of Energy (ToE) delivered volumes - "Summary" header " p 210

### 5.8.2.2. Transfer of Energy (ToE) delivered volumes - "Detail" Columns header

From the 4<sup>th</sup> column, a set of 2 columns identifies the source of each metering data for a 'Transfer of Energy (ToE) delivered volumes' component.



This sheet can contain many sets of columns.

For one column (example Columns 4 and 5):

	A	B	C	D	E	F	G	H	I	J	K	
1	Company	22XDPBSPEXample		BSPEXample								
2	Last Update	11-08-2021										
3	Status	Final		DPBSP								
4	Version	3										
5												
6		Component  Party		ToEVolumesUpInjection		ToEVolumesUpOfftake		ToEVolumesDownInjection		ToEVolumesDownOfftake		
7	DeliveredVolumeper			DeliveredVolumeper		DeliveredVolumeper		DeliveredVolumeper				
8	BSPEXample			BSPEXample		BSPEXample		BSPEXample				
9	5414Example			5414Example		5414Example		5414Example				
10												
11		Meterable type		Incoming Active Net Compensated		Outgoing Active Net Compensated		Incoming Active Net Compensated		Outgoing Active Net Compensated		
12												
13												
14												
15												
16				Value	Quality	Value	Quality	Value	Quality	Value	Quality	
17		Monthly energy		0 KWh	Valid	63 KWh	Valid	0 KWh	Valid	0 KWh	Valid	
18												
19		Quarter hourly values										
20		Date	From	To	W	W	W	W	W	W	W	
21		01-04-2021	00:00	00:15	0	N	0	N	0	N	0	N
22		01-04-2021	00:15	00:30	0	N	0	N	0	N	0	N
23		01-04-2021	00:30	00:45	0	N	0	N	0	N	0	N
24		01-04-2021	00:45	01:00	0	N	0	N	0	N	0	N
25		01-04-2021	01:00	01:15	0	N	0	N	0	N	0	N
26		01-04-2021	01:15	01:30	0	N	0	N	0	N	0	N
27		01-04-2021	01:30	01:45	0	N	0	N	0	N	0	N
28		01-04-2021	01:45	02:00	0	N	0	N	0	N	0	N
29		01-04-2021	02:00	02:15	0	N	0	N	0	N	0	N
30		01-04-2021	02:15	02:30	0	N	0	N	0	N	0	N
31		01-04-2021	02:30	02:45	0	N	0	N	0	N	0	N

Figure 33 Excel 'Transfer of Energy (ToE) delivered volumes' message – Sheet 'Detail' –columns header

For one set of columns:

Line	Name	Data type	Comment
6	Component	String	See table below
7		String	Name of Delivery Point
8	Domain	String	EAN of Delivery Point
9		EAN	EAN of Border Point (even if the component is an Interconnection Point)
11	Meterable type	String	Identification of the Metering direction( direction of the flow) Possible values are: <ul style="list-style-type: none"> <li>Outgoing (OUT): the energy is going out of this Border Point or Interconnection Point</li> <li>Incoming (IN): the energy is coming in the Border Point or Interconnection Point</li> </ul>

12	N/A	String	Identification of the power type. Always : "Active"
13	N/A	String	Fixed. Always "Net"
14	N/A	String	Always "Compensated"
17	monthly energy	String	Excel formula = the sum of all quarter hourly values and related unit
20	Power unit	String	Unit in which the power values are defined. Fixed. Always W

Table 108 Excel 'Transfer of Energy (ToE) delivered volumes' message – Sheet 'Detail' – Columns values

Component	DeliveryDirection	MeteringDirection
ToEVolumesUpInjection_DeliveredVolumeperDeliveryPoint_PerDelivery&MeteringDirection	DeliveryUp	Injection
ToEVolumesDownInjection_DeliveredVolumeperDeliveryPoint_PerDelivery&MeteringDirection	DeliveryDown	Injection
ToEVolumesUpOfftake_DeliveredVolumeperDeliveryPoint_PerDelivery&MeteringDirection	DeliveryUp	Offtake
ToEVolumesDownOfftake_DeliveredVolumeperDeliveryPoint_PerDelivery&MeteringDirection	DeliveryDown	Offtake

Table 109 Excel 'Transfer of Energy (ToE) delivered volumes' message – Sheet 'Detail' – Components

### 5.8.2.3. Transfer of Energy (ToE) delivered volumes - "Detail" Columns values

The same columns (starting from the 4<sup>th</sup> column), contain the metering values and their quality (on the next column) All the quarter hourly values of the month are present.

The format of values is the same as on the sheet "Summary". See "5.8.1.3 Transfer of Energy (ToE) delivered volumes - "Summary" Columns values " p 212.

## 5.9. Excel DGO Loop losses (DGO PBO) metering messages

The purpose of these messages is to provide the difference between volumes allocated by DGO on a quarter-hourly basis and offtakes/injections on the Elia grid.

The Excel file is made of many sheets:

- The first sheet, named "Summary", contains the 'DGOLoopLosses' components.
- The second sheet, named with the DGO network name, contains all the DGOInfeedInjectionTotal, DGOExchangeTotal and DGOAllocationInjection of this DGO.

Header is the same for all sheets.

### 5.9.1. Sheet "Summary" structure

The sheet "Summary" consists of the following sections:

- A header.
- A set of columns headers.
- A set of columns values.

### 5.9.1.1. DGO Loop losses (DGO PBO) - "Summary" header

The header contains reference of the DGO / MRCO and the state, version.

	A	B	C	D	E
1	Company	22XDGO-EXAMPLE3A		DGO Example 3	
2	Last update	21-12-2020		DGO Loop Losses (DGO PBO)	
3	Validation Status	Intermediate			
4	Version	1			

Figure 34 DGO Loop losses (DGO PBO) - Excel sheet 'Summary' -header

Excel Cell	Name	Data type	Comment
B1:C1 (merged cells)	Receiver identification code	String	EIC of the DGO receiver of the message.
D1:F1 (merged cells)	Receiver name	String	Name of the DGO receiver of the message Note this is a "display name" that can be different from the official name of the company
B2:C2 (merged cells)	Last update date	Date and time	Date and time of the creation of the highest version of this document.
D2:F2 (merged cells)	Message type	String	Fixed. Always "DGO Loop Losses (DGO PBO)"
B3:C3 (merged cells)	Message status	String	Indicate if the message is 'Intermediate', 'Final' or 'FinalModified'
B4 (merged cells)	version	Integer [1..999]	The version of the message: An integer within range [1...999]. <b>Note:</b> The first message sent is not guaranteed to have version 1.

Table 110 Excel DGO Loop losses (DGO PBO) header fields

### 5.9.1.2. DGO Loop losses (DGO PBO) - "Summary" Columns header

From the 4<sup>th</sup> column, a set of 2 columns identifies the source of each metering data for a 'Delta TS' component

This sheet can contain many sets of columns.

6	<b>Component</b>	<b>DGOLoopLosses</b>		<b>DGOLoopLosses</b>	
7	<b>Direction</b>	Incoming		Incoming	
8	<b>Domain</b>	IMEWO		Fluvius Antwerpen	
9		541453174796694517		541453182932680843	
10	<b>Party / Area</b>	IMEWO		Fluvius Antwerpen	
11		541453174796694517		541453182932680843	
12	<b>Meterable type</b>	Active		Active	
13		Net		Net	
14		Compensated		Compensated	
15					
16		Value	Quality	Value	Quality
17	Monthly energy	0 KWh	Invalid	0 KWh	Invalid
18					
19	Quarter hourly values				
20	Date From To	W		W	

Figure 35 Excel 'DGO Loop losses (DGO PBO)' message - Sheet 'Summary' - columns header

For one set of columns:

Line	Name	Data type	Comment
6	Component	String	Fixed. Always "DGOLoopLosses"
7	Direction	String	Incoming (IN)
8	Domain	String	Name of the DGO network.
9	N/A	EAN	EAN of the DGO network.
10	Party / Area	String	Same as row 8
11	N/A	String	Same as row 9
12	Meterable type	String	Fixed. Always "Net"
13	N/A	String	Identification of the power type Fixed. Always "Active"
14	N/A	String	Fixed. Always "Compensated"
17	monthly energy	String	Excel formula = the sum of all quarter hourly values and related unit
20	Power unit	String	Unit in which the power values are defined. Fixed. Always W

Table 111 Excel 'DGO Loop losses (DGO PBO)' message - Sheet 'Summary' - columns references

**5.9.1.3. DGO Loop losses (DGO PBO) - "Summary" Columns values**

The same columns (starting from the 4<sup>th</sup> column), contain the metering values and their quality (on the next column) All the quarter hourly values of the month are present

Column	Name	Data type	Comment
4, 6, 8, 10, 12, etc.	Value	Signed Decimal	Value of the power for the given quarter. The value is expressed in the defined unit and contains a maximum of 3 digits after the decimal point. In case of negative value the sign '-' is added
5, 7, 9, 11, 13, etc.	Quality	1 char	Indication as to the quality of the metered data for the given quarter (see section 1.1.3.3). Possible values are: <ul style="list-style-type: none"> <li>• N: Normal</li> <li>• I: Inexact</li> <li>• S: Substituted (Estimated replacement).</li> </ul>

Table 112 Excel 'DGO Loop losses (DGO PBO)' message - Sheet 'Summary' - Columns values

**5.9.2. Sheet [DGO Network name] structure**

**5.9.2.1. DGO Loop losses (DGO PBO) - [DGO Network name] header**

The header content is the same as the one from the 'Summary' sheet. Refer to "5.9.1.1 DGO Loop losses (DGO PBO) - "Summary" header" p 215

**5.9.2.2. DGO Loop losses (DGO PBO) - [DGO Network name] Columns header**

From the 4<sup>th</sup> column, a set of 2 columns identifies the source of each metering data for a 'DGOExchange' component

This sheet can contain many sets of columns.

For one column (example Columns 4 and 5):

6	<b>Component</b>	<b>DGOInfeedInjection Total</b>	<b>DGOInfeedOfftake Total</b>	
7	<b>Direction</b>	Incoming	Outgoing	
8	<b>Domain</b>	DGO B	DGO B	
9		541453175605410335	541453175605410335	
10	<b>Party / Area</b>	DGO B	DGO B	
11		541453175605410335	541453175605410335	
12	<b>Meterable type</b>	Active	Active	
13		Net	Net	
14		Compensated	Compensated	
15				
16		Value	Quality	Value
17	Monthly energy	0 KWh	Valid	49,238,683 KWh
18				
19	Quarter hourly values			
20	Date	From	To	W
21	01-11-2020	00-00	00-15	W

Figure 36 Excel 'DGO Loop losses (DGO PBO)' message - Sheet 'Detail' -columns header

For one set of columns:

Line	Name	Data type	Comment
------	------	-----------	---------

6	Component	String	Possible values
			DGOInfeedInjectionTotal
			DGOInfeedOfftakeTotal
			DGOExchangeInjectionTotal
			DGOExchangeOfftakeTotal
			DGOAllocationInjectionTotal
			DGOAllocationOfftakeTotal
7	Direction	String	<p>Identification of the direction of flow Possible values are:</p> <ul style="list-style-type: none"> <li>Outgoing (OUT): the energy is going out of this Border Point or Interconnection Point</li> <li>Incoming (IN): the energy is coming in the Border Point or Interconnection Point</li> </ul>
8	Domain	String	Name of DGO network.
9		EAN	EAN of DGO network.
10	Party / Area	String	Same as row 8
11	N/A	EAN	Same as row 9
12	Meterable type	String	Fixed. Always "Net"
13	N/A	String	Identification of the power type. Always : "Active"
14	N/A	String	Always "Compensated"
17	monthly energy	String	Excel formula = the sum of all quarter hourly values and related unit
20	Power unit	String	Unit in which the power values are defined. Fixed. Always W

### 5.9.2.3. DGO Loop losses (DGO PBO) - [DGO Network name] Columns values

The same columns (starting from the 4<sup>th</sup> column), contain the metering values and their quality (on the next column) All the quarter hourly values of the month are present:

The format of values is the same as on the sheet "Summary". See "5.9.1.3 DGO Loop losses (DGO PBO) - "Summary" Columns values " p 217

## 5.10. Excel Delta TS (DTS) metering messages

The purpose of these messages is to provide the difference between the energy measured by Elia at a Border Point (4.1) and the sum of the energy reported by DGO at the DGO Interconnection Points (4.2) linked to the border Point.

The Excel file is made of 2 sheets:

- The first sheet, named "Summary", contains the 'Delta TS' components.

- The second sheet, named "Detail", contains all the Border Point and DGO Interconnection Point components.

Header is the same for all sheets.

### 5.10.1. Sheet "Summary" structure

The sheet "Summary" consists of the following sections:

- A header.
- A set of columns headers.
- A set of columns values.

#### 5.10.1.1. Delta TS - "Summary" header

The header contains reference of the DGO / MRCO and the state, version.

	A	B	C	D
1	Company	22XDGO-EXAMPLE3A		DGO Example 3
2	Last update	21-12-2020		Delta TS
3	Validation Status	Intermediate		
4	Version	1		

Figure 37 Delta TS - Excel sheet 'Summary' -header

Excel Cell	Name	Data type	Comment
B1:C1 (merged cells)	Receiver identification code	String	EIC of the DGO receiver of the message.
D1:F1 (merged cells)	Receiver name	String	Name of the DGO receiver of the message Note this is a "display name" that can be different from the official name of the company
B2:C2 (merged cells)	Last update date	Date and time	Date and time of the creation of the highest version of this document.
D2:F2 (merged cells)	Message type	String	Fixed. Always "Delta TS"
B3:C3 (merged cells)	Message status	String	Indicate if the message is 'Intermediate', 'Final' or 'FinalModified'
B4 (merged cells)	version	Integer [1..999]	The version of the message: An integer within range [1...999]. <b>Note:</b> The first message sent is not guaranteed to have version 1.

Table 113 Excel Delta TS header fields

#### 5.10.1.2. Delta TS - "Summary" Columns header

From the 4<sup>th</sup> column, a set of 2 columns identifies the source of each metering data for a 'Delta TS' component

This sheet can contain many sets of columns.

	A	B	C	D	E	F	G
1	Company	22XDGO-EXAMPLE3A		DGO Example 3			
2	Last update	21-12-2020		Delta TS			
3	Validation Status	Intermediate					
4	Version	1					
5							
6	Component			Delta TS		Delta TS	
7	Direction			Incoming		Incoming	
8	Domain			ABCDE 15		AABCD 15	
9	Party / Area			541453161252993346		541453198270815617	
10				ABCDE 15		AABCD 15	
11				541453161252993346		541453198270815617	
12	Meterable type			Net		Net	
13				Active		Active	
14				Compensated		Compensated	
15							
16				Value	Quality	Value	Quality
17	Monthly energy			0 KWh	Valid	0 KWh	Valid
18	Schedules						
19							
20	Date	From	To	W		W	

Figure 38 Excel 'Delta TS' message - Sheet 'Summary' - columns header

For one set of columns:

Line	Name	Data type	Comment
6	Component	String	Fixed. Always "DeltaTS"
7	Direction	String	Incoming (IN)
8	Domain	String	Name of the Border Point
9	N/A	EAN	EAN of the Border Point.
10	Party / Area	String	Same as row 8
11	N/A	String	Same as row 9
12	Meterable type	String	Fixed. Always "Net"
13	N/A	String	Identification of the power type Fixed. Always "Active"
14	N/A	String	Fixed. Always "Compensated"
17	monthly energy	String	Excel formula = the sum of all quarter hourly values and related unit
20	Power unit	String	Unit in which the power values are defined. Fixed. Always W



Table 114 Excel 'Delta TS' message – Sheet 'Summary' – columns references

### 5.10.1.3. Delta TS - "Summary" Columns values

The same columns (starting from the 4<sup>th</sup> column), contain the metering values and their quality (on the next column) All the quarter hourly values of the month are present

Column	Name	Data type	Comment
4, 6, 8, 10, 12, etc.	Value	Signed Decimal	Value of the power for the given quarter. The value is expressed in the defined unit and contains a maximum of 3 digits after the decimal point. In case of negative value the sign '-' is added
5, 7, 9, 11, 13, etc.	Quality	1 char	Indication as to the quality of the metered data for the given quarter (see section 1.1.3.3). Possible values are: <ul style="list-style-type: none"> <li>N: Normal</li> <li>I: Inexact</li> <li>S: Substituted (Estimated replacement).</li> </ul>

Table 115 Excel 'Delta TS' message – Sheet 'Summary' – Columns values

### 5.10.2. Sheet "Detail" structure

#### 5.10.2.1. Delta TS - "Detail" header

The header content is the same as the one from the 'Summary' sheet. Refer to "5.10.1.1 Delta TS - "Summary" header " p 219

#### 5.10.2.2. Delta TS - "Detail" Columns header

From the 4<sup>th</sup> column, a set of 2 columns identifies the source of each metering data for a 'DGOExchange' component

This sheet can contain many sets of columns.

For one column (example Columns 4 and 5):

	A	B	C	D	E	F	G
1	Company	22XDGO-EXAMPLE3A		DGO Example 3			
2	Last update	21-12-2020		Delta TS			
3	Validation Status	Intermediate					
4	Version	1					
5							
6		<b>Component</b>	<b>BorderPointOfftake</b>	<b>DGOInterconnectionPointOfftake</b>	<b>GC</b>		
7		Direction	Outgoing	Outgoing			
8		Domain	ABCDE 15	ABCDE 15			
9			541453161252993346	54145316125299336			
10		Party / Area	ABCDE 15	ABCDE 15-DGOB			
11			541453161252993346	541453198643130066			
12		<b>Meterable type</b>	Net	Dgo			
13			Active	Active			
14			Compensated	Compensated			
15							
16			Value	Quality	Value	Quality	
17		Monthly energy	20,733,939 KWh	Valid	20,733,939 KWh	Valid	
18							
19		Schedules					
20	Date	From	To	W		W	

Figure 39 Excel 'Delta TS' message – Sheet 'Detail' –columns header

For one set of columns:

Line	Name	Data type	Comment
6	Component	String	Possible values
			BorderPointOfftake
			BorderPointInjection
			DGOInterconnectionPointInjection
			DGOInterconnectionPointOfftake
7	Direction	String	Identification of the direction of flow Possible values are: <ul style="list-style-type: none"> <li>Outgoing (OUT): the energy is going out of this Border Point or Interconnection Point</li> <li>Incoming (IN): the energy is coming in the Border Point or Interconnection Point</li> </ul>
8	Domain	String	Name of Border Point (even if the component is an Interconnection Point)
9		EAN	EAN of Border Point (even if the component is an Interconnection Point)
10	Party / Area	String	Name of Border Point or the Interconnection Point
11	N/A	EAN	EAN of Border Point or Interconnection Point
12	Meterable type	String	Fixed. Always "Net"
13	N/A	String	Identification of the power type. Always : "Active"
14	N/A	String	Always "Compensated"
17	monthly energy	String	Excel formula = the sum of all quarter hourly values and related unit
20	Power unit	String	Unit in which the power values are defined. Fixed. Always W

### 5.10.2.3. Delta TS - "Detail" Columns values

The same columns (starting from the 4<sup>th</sup> column), contain the metering values and their quality (on the next column) All the quarter hourly values of the month are present:

The format of values is the same as on the sheet "Summary". See "5.10.1.3 Delta TS - "Summary" Columns values " p 221

## 5.11. Excel Delta DGO Exchanges (DGO2DGO) metering messages

The purpose of these messages is to provide the difference between the energy measured by each of the DGO in a given for a given DGO and all its neighbours. See section "2.14 Delta DGO Exchanges (DGO2DGO) report" p 88.

The Excel file is made of 2 sheets:

- The first sheet, named "Summary", contains the 'DeltaDGOExchange' components. Order ascending on the Power Type (Active, Capacitive, Inductive), next on the Direction (Incoming, Outgoing). Named "Summary".
- The second sheet, named "Detail", contains all 'DGOExchange' associated with the DGO Reactive Area. Order ascending on the Supply name, next on the Power Type (Active, Capacitive, Inductive), next on the Direction (Incoming, Outgoing). Named "Detail".

Header is the same for both sheets.

### 5.11.1. Sheet "Summary" structure

The sheet "Reactive Area" consists of the following sections:

- A header.
- A set of columns headers.
- A set of columns values.

#### 5.11.1.1. DGO2DGO - "Summary" header

The header contains reference of the DGO / MRCO and the state, version.

	A	B	C	D
1	Company	22XDGO-EXAMPLE3A		DGO Name
2	Last update	21-12-2020		Delta DGO Exchanges (DGO2DGO)
3	Validation Status	Intermediate		
4	Version	1		

Figure 40 DGO2DGO - Excel sheet 'Business Summary' -header

Excel Cell	Name	Data type	Comment
B1:C1 (merged cells)	Receiver identification code	String	EIC of the DGO receiver of the message.
D1:F1 (merged cells)	Receiver name	String	Name of the DGO receiver of the message Note this is a "display name" that can be different from the official name of the company
B2:C2 (merged cells)	Last update date	Date and time	Date and time of the creation of the highest version of this document.
D2:F2 (merged cells)	Message type	String	Fixed. Always "Delta DGO Exchanges (DGO2DGO)"
B3:C3 (merged cells)	Message status	String	Indicate if the message is 'Intermediate', 'Final' or 'FinalModified'
B4 (merged cells)	version	Integer [1..999]	The version of the message: An integer within range [1...999]. <b>Note:</b> The first

			message sent is not guaranteed to have version 1.
--	--	--	---

Table 116 Excel DGO2DGO header fields

**5.11.1.2. DGO2DGO - "Summary" Columns header**

From the 4<sup>th</sup> column, a set of 2 columns identifies the source of each metering data for a 'DeltaDGOExchange' component

This sheet can contain many sets of columns.

	A	B	C	D	E	F	G
1	Company	22XDGO-EXAMPLE3A	DGO Name				
2	Last update	21-12-2020	Delta DGO Exchanges (DGO2DGO)				
3	Validation Status	Intermediate					
4	Version	1					
5							
6	Component		DeltaDGOExchange			DeltaDGOExchange	
7	Direction		Incoming			Incoming	
8	Domain		DGOA - DGOB			DGOA - DGOC	
9			DGOA - DGOB			DGOA - DGOC	
10	Party / Area		DGOA			DGOA	
11							
12	Meterable type		Net			Net	
13			Active			Active	
14			Compensated			Compensated	
15							
16			Value	Quality		Value	Quality
17	Monthly energy		0 KWh	Valid		0 KWh	Valid
18							
19	Quarter hourly values						
20	Date	From	To	W		W	
21	01-11-2020	00:00	00:15		0 N		0 N
22	01-11-2020	00:15	00:30		0 N		0 N

Figure 41 Excel 'DGO2DGO' message - Sheet 'Summary' -columns header

For one set of columns:

Line	Name	Data type	Comment
6	Component	String	Always "DeltaDGOExchange"
7	Direction	String	Incoming (IN)
8	Domain	String	[Name of DGO Owner of this file] - [Name of neighbour]
9	<empty>	String	Same as row 8
10	Party / Area	String	Name of the company which is the source of the data
12	N/A	String	Fixed. Always "Net"
13	Meterable type	String	Identification of the power type Always Active

14	N/A	String	Fixed. Always "Compensated"
17	monthly energy	String	Excel formula = the sum of all quarter hourly values and related unit
20	Power unit	String	Unit in which the power values are defined. Fixed. Always W

*Table 117 Excel 'DGO2DGO' message - Sheet 'Summary' - columns references*

### 5.11.1.3. DGO2DGO - "Summary" Columns values

The same columns (starting from the 4<sup>th</sup> column), contain the metering values and their quality (on the next column) All the quarter hourly values of the month are present

Column	Name	Data type	Comment
4, 6, 8, 10, 12, etc.	Value	Signed Decimal	Value of the transferred power for the given quarter. The value is expressed in the defined unit and contains a maximum of 3 digits after the decimal point. In case of negative value the sign '-' is added
5, 7, 9, 11, 13, etc.	Quality	1 char	Indication as to the quality of the metered data for the given quarter (see section 1.1.3.3). Possible values are: <ul style="list-style-type: none"> <li>N: Normal</li> <li>I: Inexact</li> <li>S: Substituted (Estimated replacement).</li> </ul>

Table 118 Excel 'DGO2DGO' message - Sheet 'Summary' - Columns values

### 5.11.2. Sheet "Detail" structure

#### 5.11.2.1. DGO2DGO - "Detail" header

The header content is the same as the one from the 'Summary' sheet. Refer to "5.11.1.1 DGO2DGO - "Summary" header " p 223

#### 5.11.2.2. DGO2DGO - "Detail" Columns header

From the 4<sup>th</sup> column, a set of 2 columns identifies the source of each metering data for a 'DGOExchange' component

This sheet can contain many sets of columns.

For one column (example Columns 4 and 5):

6	<b>Component</b>	<b>DGOExchange</b>	<b>DGOExchange</b>
7	<b>Direction</b>	Incoming	Outgoing
8	<b>Domain</b>	DGOA -DGOB	DGOA -DGOB
9	<b>Party / Area</b>	DGOA -DGOB	DGOA -DGOB
10		DGOA	DGOA
11		5115340458901	5115340458901
12	<b>Meterable type</b>	Net	Net
13		Active	Active
14		Compensated	Compensated
15			
16		Value	Quality
17	Monthly energy	2,762,605 KWh	Valid
18			
19	Quarter hourly values		
20	Date From To	W	W

Figure 42 Excel 'DGO Reactive Area' message - Sheet 'Supply Bay' -columns header

For one set of columns:

Line	Name	Data type	Comment
6	Component	String	Always "DGOExchange"

7	Direction	String	Identification of the direction of flow Possible values are: <ul style="list-style-type: none"> <li>Outgoing (OUT): the energy is going out the owner DGO Area to the neighbour DGO</li> <li>Incoming (IN): the energy is coming in the owner DGO Area from the neighbour DGO</li> </ul>
8	Domain	String	[Name of DGO Owner of this file] – [Name of neighbour]
9		String	[Name of DGO Owner of this file] – [Name of neighbour]
10	Party / Area	String	The data owner name.
11	N/A	EAN	The data owner GLN.
12	N/A	String	Fixed. Always "Net"
13	Meterable type	String	Identification of the power type. Always : "Active"
14	N/A	String	Always "Compensated"
17	monthly energy	String	Excel formula = the sum of all quarter hourly values and related unit
20	Power unit	String	Unit in which the power values are defined. Fixed. Always W

**5.11.2.3. DGO2DGO - "Detail" Columns values**

The same columns (starting from the 4<sup>th</sup> column), contain the metering values and their quality (on the next column) All the quarter hourly values of the month are present:

The values are the same as on the sheet "Summary". See "5.11.1.3 DGO2DGO - "Summary" Columns values " p 226

	A	B	C	D	E	F	G
1	Company	22YDGO-----1		DGO A			
2	Last update	21-12-2020		Delta DGO Exchanges (DGO2DGO)			
3	Validation Status	Intermediate					
4	Version	1					
5							
6	<b>Component</b>			<b>DGOExchange</b>		<b>DGOExchange</b>	
7	Direction			Incoming		Outgoing	
8	Domain			DGO A - DGO B		DGO A - DGO B	
9				DGO A - DGO B		DGO A - DGO B	
10	Party / Area			DGO A		DGO A	
11				5115340458888		5115340458888	
12	Meterable type			Net		Net	
13				Active		Active	
14				Compensated			
15							
16				Value	Quality	Value	Quality
17	Monthly energy			0 KWh	Invalid	3,794 KWh	Invalid
18							
19	Quarter hourly values						
20	Date	From	To	W		W	
21	01-11-2020	00:00	00:15	0	I	9,450	I
22	01-11-2020	00:15	00:30	0	I	7,350	I

### 5.12. Excel Real-Time DGO Allocation messages

Real-Time DGO Allocation messages contain information related to the Elia Real-Time estimate on DGO Allocation, with both the estimate and the quality of the estimate (based on the available variables for making the estimation. Please refer to "2.11 Real-Time DGO Allocation" on page 73 and "2.11.3.4 Excel (XLSX) Real-Time DGO Allocation" on page 79 for more information.

	A	B	C	D	E	F	G
1	Company	22XBRPB-----0		BRP test			
2	Last Update	26-10-2020		Prediction			
3	Status	Intermediate					
4	Version	4598					
6	Component			DGOAllocationEstimateQuality		DGOAllocationEstimateTotal	
7	Direction			Incoming		Incoming	
8	Description						
9				Value	Quality	Value	Quality
10	Monthly energy			59 K%h	Valid	35,358,530 KWh	Valid
12	Quarter hourly values						
13	Date	From	To	%		W	
14	01-10-2020	00:00	00:15	100	N	45,540,000	N
15	01-10-2020	00:15	00:30	100	N	46,440,000	N
16	01-10-2020	00:30	00:45	100	N	45,280,000	N
17	01-10-2020	00:45	01:00	100	N	45,010,000	N
18	01-10-2020	01:00	01:15	100	N	46,710,000	N
19	01-10-2020	01:15	01:30	100	N	48,000,000	N
20	01-10-2020	01:30	01:45	100	N	49,670,000	N
21	01-10-2020	01:45	02:00	100	N	50,600,000	N
22	01-10-2020	02:00	02:15	100	N	52,320,000	N
23	01-10-2020	02:15	02:30	100	N	52,390,000	N
24	01-10-2020	02:30	02:45	100	N	52,860,000	N
25	01-10-2020	02:45	03:00	100	N	51,010,000	N

Figure 43 Fields in an Real-Time DGO Allocation message

#### 5.12.1. Message structure

The Real-Time DGO Allocation metering message consists of the following sections:

- A header.
- A set of columns headers.
- A set of columns values.

##### 5.12.1.1. Header

The header contains reference of the BRP and the state, version.

	A	B	C	D
1	Company	A03-22XTEST-ARP-ARPA		Test ARP
2	Last Update	12-11-2019		Prediction
3	Status	Intermediate		
4	Version	781		

Figure 44 Excel Imbalance message -header

Excel Cell	Name	Data type	Comment
B1:C1 (merged cells)	Receiver identification code	String	EIC company code of the receiver of the message.
D1:F1 (merged cells)	Receiver name	String	Name of the company receiver of the message. Note this is a "display name" that can be different from the official name of the company



B2:C2 (merged cells)	Message status	String	Fixed. Always 'Intermediate'
D2:F2 (merged cells)	Message type	String	Fixed. Always "Prediction"
B3:C3 (merged cells)	Last update date	Date and time	Date and time of the creation of the highest version of this document.
B4:C4 (merged cells)	version	Integer [1..2999]	The version of the message: An integer within range [1...2999]. <b>Note:</b> The first message sent is not guaranteed to have version 1.

Table 119 Excel Access Point header fields

### 5.12.1.2. Columns header

From the 4<sup>th</sup> column, a set of 2 columns identifies the source of each metering data for one component

An Excel sheet contains 3 columns:

- Date and time
- DGOInjectionEstimateQualityTotal: This column provides the quality of the estimation, based on the availability of variables for the estimation model
- DGOAllocationEstimateTotal: The estimated Real-Time DGO Allocation.

5		Component	DGOInjectionEstimateQualityTotal	DGOAllocationEstimateTotal
7		Direction	Incoming	Incoming
8		Description		
9			Value	Quality
0		Monthly energy	0 K%h	Valid
1			22.613.648 KWh	Valid
2		Quarter hourly values		
3		Date From To	%	W

Figure 45 Excel Real-Time DGO Allocation message –columns header

Line	Name	Data type	Comment
6	Component	String	One of the possible components. See "2.11.3.1 Real-Time DGO Allocation components" on page 76.
7	Direction	String	Identification of the direction of flow (see section see "2.11.3.1 Real-Time DGO Allocation components" on page 76) <ul style="list-style-type: none"> <li>• Incoming (IN): the energy is coming in the BRP balance perimeter</li> </ul>
8	Party or Area	String	Not Applicable
10	Sum of the monthly energy		Excel formula = the sum of all quarter hourly values and related unit
11	Power unit	String	Unit in which the power values are defined. Possible values are: <ul style="list-style-type: none"> <li>- W</li> <li>- %</li> </ul>

Table 120 Excel Imbalance column metering reference

### 5.12.1.3. Columns values

The same columns (starting from the 4<sup>th</sup> column), contain the metering values and their quality (on the next column) All the quarter hourly values of the month are present

Column	Name	Data type	Comment
4, 6, 8, 10, 12, etc.	Value	Signed Decimal	Value of the transferred power, or estimate quality, for the given quarter. The value is expressed in the defined unit and contains a maximum of 3 digits after the decimal point. In case of negative value the sign '-' is added
5, 7, 9, 11, 13, etc.	Quality	1 char	Indication as to the quality of the metered data for the given quarter (see section 1.1.3.3). Possible values are: <ul style="list-style-type: none"> <li>• N: Normal</li> <li>• I: Inexact</li> <li>• S: Substituted (Estimated replacement).</li> </ul>

Table 121 Excel Imbalance [schedule] fields

## 5.13. Excel DGO Border Point and Supply Bay (DGOBP) metering messages

'DGO Border Point and Supply Bay (DGOBP)' messages contain metering data about one DGO Area. See section "2.12 DGO Border Point and Supply Bay metering" p 80 .

The Excel file is made of 2 sheets:

- The first sheet contains the Border Points components. Order ascending on the Power Type (Active, Capacitive, Inductive), next on the Direction (Incoming, Outgoing). Named "BorderPoint".
- The second sheet contains all Supply bay points associated with the Border Point. Order ascending on the Supply name, next on the Power Type (Active, Capacitive, Inductive), next on the Direction (Incoming, Outgoing). Named "SupplyBay".

Header is the same for both sheets.

### 5.13.1. Sheet "BorderPoint" structure

The sheet "BorderPoint" consists of the following sections:

- A header.
- A set of columns headers.
- A set of columns values.

#### 5.13.1.1. "BorderPoint" header

The header contains reference of the DGO / MRCO and the state, version.

	A	B	C	D	E
1	Company	22XDGO--EXAMPLEG		DGO Example	
2	Last update	31-12-2020		DGO Border Point and Supply Bay	
3	Validation Status	Intermediate			
4	Version	1			

Figure 46 Excel sheet 'DGO Border Point and Supply Bay (DGOBP)' - header

Excel Cell	Name	Data type	Comment
B1:C1 (merged cells)	Receiver identification code	String	EIC of the receiver of the message.
D1:F1 (merged cells)	Receiver name	String	Name of the receiver of the message <b>Note:</b> this is a "display name" that can be different from the official name of the company
B2:C2 (merged cells)	Last update date	Date and time	Date and time of the creation of the highest version of this document.
D2 (merged cells)	Message name	String	Always "DGO Border Point and Supply Bay"
B3:C3 (merged cells)	Message status	String	DGO Border Point and Supply Bay
B4	version	Integer [1..999]	The version of the message: An integer within range [1...999]. <b>Note:</b> The first message sent is not guaranteed to have version 1.

Table 122 Excel DGO Border Point and Supply Bay (DGOBP)' header fields

### 5.13.1.2. "BorderPoint" Columns header

From the 4<sup>th</sup> column, a set of 2 columns identifies the source of each metering data for one component

An Excel 'DGO Border Point and Supply Bay (DGOBP)' sheet can contain many sets of columns.

Component	BorderPointOfftake		BorderPointInjection	
Direction	Outgoing		Incoming	
Domain	BP 1 name		BP 1 name	
Party / Area	541453179072207214		541453179072207214	
	BP 1 name		BP 1 name	
	541453179072207214		541453179072207214	
Meterable type	Active		Active	
	Net		Net	
	Compensated		Compensated	
	Value	Quality	Value	Quality
Monthly energy	4,329,437 KWh	Invalid	0 KWh	Invalid
ues				
To	W		W	

Figure 47 Excel 'DGO Border Point and Supply Bay (DGOBP)' message – Sheet 'BorderPoint' –columns header

For one set of columns:

Line	Name	Data type	Comment
6	Component	String	One of the possible components. Possible values:

			Component	Related direction				
			BorderPointOfftake	Outgoing				
			BorderPointInjection	Incoming				
7	Direction	String	Identification of the direction of flow Possible values are: <ul style="list-style-type: none"> <li>Outgoing (OUT): the energy is going out from the Border point to Elia Grid</li> <li>Incoming (IN): the energy is coming in the Border point from Elia Grid</li> </ul>					
8	Domain	String	The Border Point name					
9	N/A	EAN	The Border Point EAN.					
10	Party / Area	String	Same as on row 8					
11	N/A	EAN	Same as on row 9					
12	Meterable type	String	Identification of the power type Possible values are: <table border="1" data-bbox="849 965 1129 1167"> <thead> <tr> <th>Value</th> </tr> </thead> <tbody> <tr> <td>Active</td> </tr> <tr> <td>Capacitive</td> </tr> <tr> <td>Inductive</td> </tr> </tbody> </table>		Value	Active	Capacitive	Inductive
Value								
Active								
Capacitive								
Inductive								
13	N/A	String	Fixed. Always "Net"					
14	N/A	String	Fixed. Always "Compensated"					
17	Monthly energy	String	Excel formula = the sum of all quarter hourly values and related unit					
20	Power unit	String	Unit in which the power values are defined. Fixed. Always W					

Table 123 Excel 'DGO Border Point and Supply Bay (DGOBP)' message – Sheet 'Border Point' – columns references

**5.13.1.3. "BorderPoint" Columns values**

The same columns (starting from the 4<sup>th</sup> column), contain the metering values and their quality (on the next column) All the quarter hourly values of the month are present

Column	Name	Data type	Comment
4, 6, 8, 10, 12, etc.	Value	Signed Decimal	Value of the transferred power for the given quarter. The value is expressed in the defined unit and contains a maximum of 3 digits after the decimal point. In case of negative value the sign '-' is added
5, 7, 9, 11, 13, etc.	Quality	1 char	Indication as to the quality of the metered data for the given quarter (see section 1.1.3.3). Possible values are: <ul style="list-style-type: none"> <li>• N: Normal</li> <li>• I: Inexact</li> <li>• S: Substituted (Estimated replacement).</li> </ul>

Table 124 Excel 'DGO Border Point and Supply Bay (DGOBP)' - Sheet 'Border Point' – Columns values

**5.13.2. Sheet "Supply Bay" structure**

**5.13.2.1. "Supply Bay" header**

The header content is the same as the one from the 'Border Point' sheet. Refer to 5.13.1.1 "BorderPoint" header p 230

**5.13.2.2. "Supply Bay" Columns header**

From the 4<sup>th</sup> column, 2 columns identify the source of each metering data metered at the Supply Bay A Excel sheet can contain the same set of columns as all MeteringRights of all BorderPoints and SupplyBays of a DGO

For one column (example Columns 4 and 5):

Component	SupplyBayOfftake	
Direction	Outgoing	
Domain	BP 1 name	
Party / Area	541453179072207214	
	Supply Bay 11 name	
Meterable type	541453139750307797	
	Active	
	Net	
	NonCompensated	
	Value	Quality
Monthly energy	0 KWh	Invalid
values		
m To	W	

Figure 48 Excel 'DGO Border Point and Supply Bay (DGOBP)' message – Sheet 'Supply Bay' –columns header

For one set of columns:

Line	Name	Data type	Comment	
6	Component	String	One of the possible components. Possible values:	
			Component	Related direction
			SupplyBayOfftake	Outgoing
			SupplyBayInjection	Incoming
7	Direction	String	Identification of the direction of flow Possible values are: <ul style="list-style-type: none"> <li>Outgoing (OUT): the energy is going out the Supply Bay to Elia Grid</li> <li>Incoming (IN): the energy is coming in the Supply Bay Area from Elia Grid</li> </ul>	
8	Domain	String	The Border Point name.	
9	N/A	EAN	The Border Point EAN.	
10	Party / Area	String	The Supply Bay name.	
11	N/A	EAN	The Supply Bay EAN.	
12	Meterable type	String	Identification of the power type Possible values are:	
			Value	
			Active	
			Capacitive	
			Inductive	
13	N/A	String	Fixed. Always "Net"	
14	N/A	String	Fixed. Always "Compensated"	
17	monthly energy	String	Excel formula = the sum of all quarter hourly values and related unit	
20	Power unit	String	Unit in which the power values are defined.	
			Fixed. Always W	

### 5.13.2.3. "Supply Bay" Columns values

The same columns (starting from the 4<sup>th</sup> column), contain the metering values and their quality (on the next column) All the quarter hourly values of the month are present. He rules are the same as "5.13.1.3 "BorderPoint" Columns values " p 233

## 5.14. Excel DGO Reactive Area and Supply Bay metering messages

'DGO Reactive Area and Supply Bay metering' messages contain Inductive and Capacitive metering data about one DGO Area. See section "2.16 DGO Reactive Area and Supply Bay (DGO RA) " p 98.

This means that if the DGO operates many DGO Reactive areas, he receives many Excel files

The Excel file is made of 2 sheets:

- The first sheet contains the DGO Reactive Area components. Order ascending on the Power Type (Active, Capacitive, Inductive), next on the Direction (Incoming, Outgoing). Named "Reactive Area".
- The second sheet contains all Supply bay points associated with the DGO Reactive Area. Order ascending on the Supply name, next on the Power Type (Active, Capacitive, Inductive), next on the Direction (Incoming, Outgoing). Named "SupplyBay".

Header is the same for both sheets.

#### 5.14.1. Sheet "Reactive Area" structure

The sheet "Reactive Area" consists of the following sections:

- A header.
- A set of columns headers.
- A set of columns values.

##### 5.14.1.1. "Reactive Area" header

The header contains reference of the DGO / MRCO and the state, version.

	A	B	C	D	E
1	<b>Company</b>	11X11111111----B		<b>DGO Name</b>	
2	<b>Meterable</b>	541453170095461607		<b>DGO Reactive Area name</b>	
3	<b>Last update</b>	18-06-2020			
4	<b>Validation St:</b>	Final			
5	<b>Version</b>	1			

Figure 49 Excel sheet 'Reactive Area' -header

Excel Cell	Name	Data type	Comment
B1:C1 (merged cells)	Receiver identification code	String	EIC of the receiver of the message.
D1:F1 (merged cells)	Receiver name	String	Name of the receiver of the message Note this is a "display name" that can be different from the official name of the company
B2:C2 (merged cells)	Meterable EAN	String	EAN of the Reactive Area
D2:F2 (merged cells)	Meterable name	String	Name of the Reactive Area
B3:C3 (merged cells)	Last update date	Date and time	Date and time of the creation of the highest version of this document.
B4 (merged cells)	Message status	String	Indicate if the message is 'Intermediate', 'Final' or 'FinalModified'
B5 (merged cells)	version	Integer [1..999]	The version of the message: An integer within range [1...999]. <b>Note:</b> The first message sent is not guaranteed to have version 1.

Table 125 Excel DGO Reactive Area header fields

### 5.14.1.2. "Reactive Area" Columns header

From the 4<sup>th</sup> column, a set of 2 columns identifies the source of each metering data for one component

An Excel 'Reactive Area' sheet can contain many sets of columns.

Component	ReactiveAreaOfftake		ReactiveAreaInjection		ReactiveAreaOfftake		ReactiveAreaInjection	
Direction	Outgoing		Incoming		Outgoing		Incoming	
Domain	DGO Reactive Area name 541453170095461607		DGO Reactive Area name 541453170095461607		DGO Reactive Area name 541453170095461607		DGO Reactive Area name 541453170095461607	
Party / Area	DGO Reactive Area name 541453170095461607		DGO Reactive Area name 541453170095461607		DGO Reactive Area name 541453170095461607		DGO Reactive Area name 541453170095461607	
Meterable type	Active Net Compensated		Active Net Compensated		Capacitive Net Compensated		Capacitive Net Compensated	
	Value	Quality	Value	Quality	Value	Quality	Value	Quality
Monthly energy	2,504,304 KWh	Valid	600,805 KWh	Valid	142,003 KVARh	Valid	7,480 KVARh	Valid
Quarter hourly values								
Date	From	To	W	W	VAR		VAR	

Figure 50 Excel 'DGO Reactive Area' message – Sheet 'Reactive Area' –columns header

For one set of columns:

Line	Name	Data type	Comment						
7	Component	String	One of the possible components. Possible values: <table border="1" data-bbox="850 1099 1406 1279"> <tr> <td>Component</td> <td>Related direction</td> </tr> <tr> <td>ReactiveAreaOfftake</td> <td>Outgoing</td> </tr> <tr> <td>ReactiveAreaInjection</td> <td>Incoming</td> </tr> </table>	Component	Related direction	ReactiveAreaOfftake	Outgoing	ReactiveAreaInjection	Incoming
Component	Related direction								
ReactiveAreaOfftake	Outgoing								
ReactiveAreaInjection	Incoming								
8	Direction	String	Identification of the direction of flow Possible values are: <ul style="list-style-type: none"> <li>Outgoing (OUT): the energy is going out the DGO Reactive Area to Elia Grid</li> <li>Incoming (IN): the energy is coming in out the DGO Reactive Area to Elia Grid</li> </ul>						
9	Domain	String	The DGO Reactive Area name						
10	N/A	EAN	The DGO Reactive Area EAN. Is the same as the EAN indicated the Header on cells B2:C2						
11	Party / Area	String	Same as on line 89						
12	N/A	EAN	The EAN DGO Reactive Area name. Is the same as the EAN indicated the Header on cells B2:C2						
13	Meterable type	String	Identification of the power type Possible values are:						



			Value	
			Active	
			Capacitive	
			Inductive	
14	N/A	String	Fixed. Always "Net"	
15	N/A	String	Fixed. Always "Compensated"	
18	monthly energy	String	Excel formula = the sum of all quarter hourly values and related unit	
21	Power unit	String	Unit in which the power values are defined. Fixed. Always W	

Table 126 Excel 'DGO Reactive Area' message – Sheet 'Reactive Area' –columns references

### 5.14.1.3. "Reactive Area" Columns values

The same columns (starting from the 4<sup>th</sup> column), contain the metering values and their quality (on the next column) All the quarter hourly values of the month are present

Column	Name	Data type	Comment
4, 6, 8, 10, 12, etc.	Value	Signed Decimal	Value of the transferred power for the given quarter. The value is expressed in the defined unit and contains a maximum of 3 digits after the decimal point. In case of negative value the sign '-' is added
5, 7, 9, 11, 13, etc.	Quality	1 char	Indication as to the quality of the metered data for the given quarter (see section 1.1.3.3). Possible values are: <ul style="list-style-type: none"> <li>• N: Normal</li> <li>• I: Inexact</li> <li>• S: Substituted (Estimated replacement).</li> </ul>

Table 127 Excel 'DGO Reactive Area' Columns values

### 5.14.2. Sheet "Supply Bay" structure

#### 5.14.2.1. "Supply Bay" header

The header content is the same as the one from the 'Reactive Area' sheet. Refer to "5.14.1.1 "Reactive Area" header " p 235

#### 5.14.2.2. "Supply Bay" Columns header

From the 4<sup>th</sup> column, 2 columns identify the source of each metering data metered at the Supply Bay

A Excel sheet can contain the same set of columns as all MeteringRights of all BorderPoints and SupplyBays of a DGO

For one column (example Columns 4 and 5):

<b>Component</b>	<b>SupplyBayOfftake</b>
<b>Direction</b>	Outgoing
<b>Domain</b>	ABEE 15
<b>Party / Area</b>	541453165197390313 ABEE 15 T 1 70/ 15 541453133839052912
<b>Meterable type</b>	Active Net Compensated
	Value    Quality
Monthly energy	Valid
Quarter hourly values	
Date      From      To	W

Figure 51 Excel 'DGO Reactive Area' message – Sheet 'Supply Bay' –columns header

For one set of columns:

Line	Name	Data type	Comment	
7	Component	String	One of the possible components. Possible values:	
			Component	Related direction
			SupplyBayOfftake	Outgoing
			SupplyBayInjection	Incoming
8	Direction	String	Identification of the direction of flow Possible values are: <ul style="list-style-type: none"> <li>Outgoing (OUT): the energy is going out the DGO Reactive Area to Elia Grid</li> <li>Incoming (IN): the energy is coming in out the DGO Reactive Area to Elia Grid</li> </ul>	
9	Domain	String	The Border Point name.	
10	N/A	EAN	The Border Point EAN.	
11	Party / Area	String	The Supply Bay name.	
12	N/A	EAN	The Supply Bay EAN.	
13	Meterable type	String	Identification of the power type Possible values are:	
			Value	
			Active	
			Capacitive	
	Inductive			
14	N/A	String	Fixed. Always "Net"	
15	N/A	String	Fixed. Always "Compensated"	
18	monthly energy	String	Excel formula = the sum of all quarter hourly values and related unit	
21	Power unit	String	Unit in which the power values are defined. Fixed. Always W	

#### 5.14.2.3. "Supply Bay" Columns values

The same columns (starting from the 4<sup>th</sup> column), contain the metering values and their quality (on the next column) All the quarter hourly values of the month are present. He rules are the same as "5.14.1.3 "Reactive Area" Columns values " p 238

## Chapter 6 Accessing messages

Elia provides 2 different protocols in order to deliver the messages to the clients:

- "EvmsB2C": The client can access on a dedicated metering website using the HTTP protocol. He can manually download the messages on this web page. This protocol is dedicated to Business operational persons wishing to download easily a few metering messages. Elia does not recommend to implement any automated way to download messages through "EvmsB2C"
- "SFTP": Clients can access their messages through the Elia SFTP servers.

### 6.1. Characteristics of the different protocols

The 2 protocols have their own advantages and disadvantages.

Here below, a summary of the different advantages and disadvantages.

Protocol	Description	Advantages	Disadvantages
EVMSB2C	Web site	No investment from the client Zero learning time: Only a web browser is needed	The download is manual.
SFTP	Secure File Transfer Protocol	Existing protocol Allow full automatic connection to download the metering message in the client application	This protocol is not widely permitted: Some IT department block the use of this protocol The password must be updated every 120 days if no certificate is provided by the client: See "6.3.1 Use of certificates: Public key – private key" page 241

### 6.2. The EVMSB2C protocol

Elia provides a proprietary application allowing clients to access their metering data using the HTTPS protocol. This is the Elia Validated Metering system for Business to Consumer ("EvmsB2C").

Clients can manually download their metering messages and save them on their disks



Figure 52 Delivery of metering data via the EVMSB2C web site

This delivery method is straightforward: When logged, only one page is available with the last messages to be downloaded. A simple search can be used to retrieve easily the needed message

### 6.3. SFTP protocol

In addition to the EVMSB2C protocol (described in sections 6.2), Elia can also publish the metering messages on a secure FTP server.

SFTP or "Secure File Transfer Protocol" is a standard network protocol used to exchange files over a network. The protocol is easy to implement and is available on all types of computers and operating systems.

Using FTP has the following advantages:

- it is a well-known standard
- it is easy to implement
- it is Operating System independent
- it provides a secured file transfer
- Basically, SFTP works with a user id /password (exception: see section 6.3.1)

To facilitate the management of the metering messages, the different types of messages are stored in separate subfolders. The client can list the contents of each folder. The messages (or files) can be read and stored locally on the file system and can be deleted after successful treatment.

The figure below shows a typical screenshot of a graphical user interface (SFTP client) showing the different subfolders.

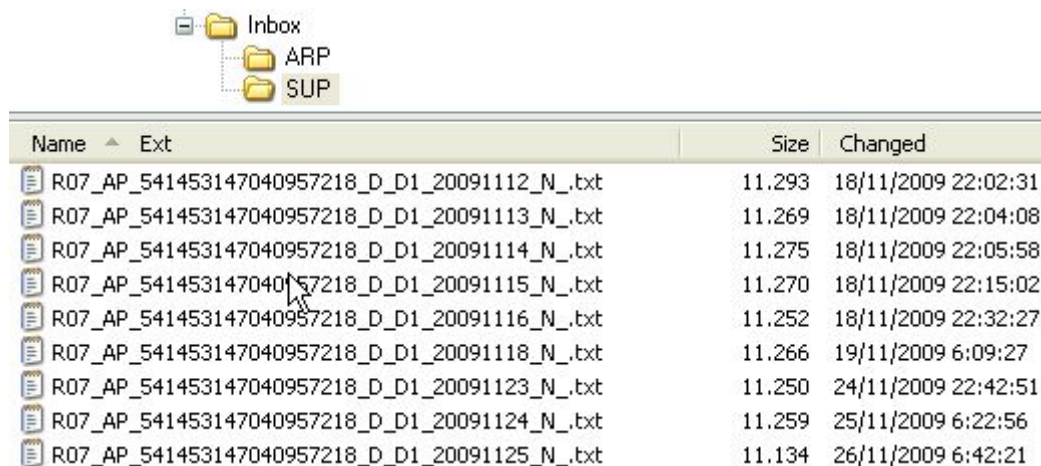

Figure 53 Folder structure on the Elia FTP client

Please contact your KAM or "metering Services" (see coordinates on the first page) to obtain a username and password to access the Elia FTP server.

#### 6.3.1. Use of certificates: Public key – private key

One of the problems with the SFTP server is the use of a password: This password has an expiration time. Even if a reminder email can be sent to the client, it arrives that the password is expired and the client is blocked if this one has an automated way to retrieve the messages.

To avoid the use of password, the client may use a certificate.

The certificate implements the concept of public and private key for authorization and authentication:

- A public key can be viewed as a lock device.
- A private key can be viewed as an actual key. This is the device used to open the 'lock' (Public key) that is stored on the other machine.

Like a regular key, the private key must be kept secret, safe, and out of the wrong hands.



Figure 54 Private and public key images

Just like a real life key system, it is not a problem if there are hundreds of the same 'lock' on many systems, as long as the private key stays ... private.

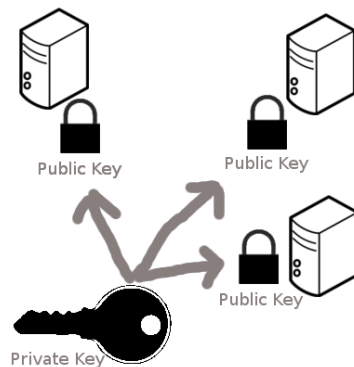

Figure 55 Private and public key on computers

This public key can therefore be distributed anywhere.

Currently most companies have such a certificate composed of a private and public key: check with your IT department.

When this public key is put on the Elia SFTP server, this one will be used and no longer the password.

Please contact your KAM or "metering Services" (see coordinates on the first page) in order to place your public key on the Elia's SFTP server.

## 6.4. Metering messages name

Each protocol uses a name (title) to allow distinguishing the message: It can be the file name downloaded from the EVMSB2C or the SFTP server.

This chapter lists, for each protocol how each file name or “message type” is constructed

### 6.4.1. EVMSB2C message file names

The type of a metering message when downloaded is a string constructed as follows:

```
[Recipient EIC]_[Recipient role]_[MsgType]_[Meterable
EAN]_[YearMonth]_[Validity].[Extension]
```

[Recipient EIC] is the EIC of the message recipient

[RecipientRole] is the role of the recipient of the message and can take the values:

[RecipientRole]	Description
ACH	Access Contract Holder
ARP	Access Responsible Party (former name of the BRP)
BSP	Balance Service Provider/ Flexibility Service Provider
CDSO	CDS Operator
GU	Grid User
DGO	Distribution Grid Operator
GLOBAL	Metering Contract Holder
MRCO	Meter Reading Company
PROD	Producer
SUP	Supplier

[MsgType] refers to the type of the message and can take the values:

[MsgType]	Description	Remark
AP	Access Point & Real-Time DGO Allocation	
CA	CDS Access Point	Same format as Access Point
CDSPBO	CDS Loop Losses (PBO)	
DCP	Infeed TSO per substation and per supply bay	
DGOBP	Infeed TSO per substation	
GEMP	Global Elia Metering Position	
IMB	Imbalance	
MP	Metering Point	
SP	Service Point	Same format as Access Point
DPBSP	Delivered volumes	

[Meterable EAN] = EAN code identifying the point referenced by this message. If there is no such object then "000000000000000000" is used

[YearMonth] is the year and month covered.. Format "YYYYMM"

[Validity] indicate if the message is validated or not

[Validity]	Description
V	Validated
N	Not Validated

[Extension] is the publication format and can take the values:

[PubFormat]	Description
CSV	Comma Separated Values
XLSX	Excel file (XLSX qualifier)
XML	eXtensible Markup Language

#### 6.4.2. FTP Metering message file names

The file name of the metering message. It is constructed according to the following pattern:

[RecipientRole]\_[MsgType]\_[EAN-code]\_M\_M1\_[schedule-time]\_Validity\_Id.Extension

RecipientRole =

[Recipient Role]	Description
R02	Meter Reading Company (MRCO)
R03	Grid User (GU)
R04	Access Contract Holder (ACH)
R05	Balance Responsible Party (BRP)
R06	Distribution Grid Operator (DGO)
R07	Supplier
R08	Producer
R09	Metering Contract Holder (MCH)
R10	CDS Operator (CDSO)
R11	Reserved
R12	Balance Service provider (BSP)/ Flexibility Service Provider (FSP)

MsgType = Same as "6.4.1 EVMSB2C message file names "page243

EAN-code = EAN code identifying the point

Schedule-time = yyyyymm

Validity=

- V (validated)
- N (non-validated)

Id= unique identifier of the message

Extension =

- txt for a csv formatted message
- xml for an xml formatted message
- xlsx for an Excel formatted message



Examples of non-validated filenames:

- R03\_AP\_541453166475361582\_M\_M1\_200603\_N\_1716367.txt
- R04\_AP\_541453199001109600\_M\_M1\_200603\_N\_1720579.txt
- R09\_MP\_541453155970400575\_M\_M1\_200603\_N\_1720367.txt
- R06\_DCP\_541453110145211219\_M\_M1\_200603\_N\_1720368.txt
- R10\_CDSPBO\_541453184162545206\_M\_M1\_201507\_N\_569095.xlsx

Example of validated filename:

- R03\_AP\_541453132606828217\_M\_M1\_200602\_V\_1716404.txt
- R09\_DCP\_541453110145211219\_M\_M1\_200602\_V\_1716405.txt
- R12\_AP\_541453104544500333\_M\_M1\_201508\_V\_178954.txt
- R12\_SP\_541453104544500340\_M\_M1\_201611\_V\_123456.xlsx
- R12\_MP\_541453104544500357\_M\_M1\_201712\_V\_78954.xml
- R12\_CA\_541453104544500364]\_M\_M1\_201701\_V\_789654.txt
- R10\_CDSPBO\_541453184162545206\_M\_M1\_201508\_V\_15112320.xml

## 6.5. Time formatting and Daylight saving

This section describes the format of times and dates used in metering messages and deals with the issues arising from daylight saving.

### 6.5.1. Time and date formatting

Times and dates are presented in the ISO 8601 format in CSV and XML formats. Date and time are expressed in UTC (Coordinated Universal Time) usually denoted by the letter Z. Time zones are expressed as an offset from UTC.

ISO 8601 format is:

yyyy-mm-ddThh:nn:ssZ or yyyy-mm-ddThh:nn:ss+xx:yy

where

yyyy = year  
 mm = month  
 dd = day  
 T: flag to indicate Time  
 hh = hour  
 nn = minute  
 ss = second  
 Z = Flag indicating that the time is in UTC

or

+ = a flag to indicate the positive offset of the time from UTC  
 xx:yy = is the offset from UTC expresses in xx hours and yy minutes.

If the time zone offset is not indicated, UTC is assumed.

### Examples

A local time of 1:20 pm on May 31st, 2009 in Brussels (which is 2 hours ahead of UTC) is written in UTC notation as

2009-05-31T11:20:00Z

or

2009-05-31T13:20:00+02:00

The date, May the 31st 2019, is written as: 2019-05-31

### 6.5.2. Daylight saving

Due to daylight saving measures, twice during the year the local time is changed by one hour meaning that there is one day that contains only 23 hours and another that contains 25 hours. This has implications on the contents of metering messages.

Date and time are expressed in UTC (Coordinated Universal Time).

So during winter time, the day begins at 23:00h UTC (the equivalent of 00:00h local time). During summer time, the day begins at 22:00h UTC (the equivalent 00:00h local time).

For example in summer time:

Local time	ISO format	UTC
1:20 pm on May 31st, 2009	2009-05-31T13:20:00+02:00	2009-05-31 11:20:00

In winter time

Local time	ISO format	UTC
1:20 pm on January 31st, 2009	2009-01-31T13:20:00+01:00	2009-05-31 12:20:00

The example below shows the transition from summer time to winter time in Belgium on the 31<sup>st</sup> of October in 2010.

Local time	ISO format	UTC
0h	2010-10-31 00:00+02	2010-10-30 22:00
1h	2010-10-31 01:00+02	2010-10-30 23:00
2h	2010-10-31 02:00+02	2010-10-31 00:00
at 3h it is 2h	2010-10-31 02:00+01	2010-10-31 01:00
3h	2010-10-31 03:00+01	2010-10-31 02:00

The example below shows the transition from winter time to summer time in Belgium on the 28<sup>th</sup> of March in 2010.

Local time	ISO format	UTC
0h	2010-03-28 00:00+01	2010-03-27 23:00
1h	2010-03-28 01:00+01	2010-03-28 00:00
at 2h it is 3h	2010-03-28 03:00+02	2010-03-28 01:00
4h	2010-03-28 04:00+02	2010-03-28 02:00

### 6.5.3. Value periods in a message

The metering message are composed of power values for each quarter ('value periods') of each day of a month

The number of value periods in a message depends on the number of hours in the day and the number of days in the month.

For a 'normal' 24 hour day:

number of minutes = 1440

number of value periods  $1440 / 15 = 96$

All 96 values and qualities are consecutive.

For a 23 hour day:

number of minutes = 1380

number of value periods  $1380 / 15 = 92$

The value periods between 2h and 3h are omitted. There are therefore 4 less value periods in the daily message and the corresponding message.

For a 25 hour day:

number of minutes = 1500

number of value periods  $1500 / 15 = 100$

Four additional values periods are inserted after the 2h-3h value periods. There are 4 additional values periods in both the daily message and the corresponding message

For a 28 day month:

number of minutes = 40320

number of value periods  $40320 / 15 = 2688$

For a 29 day month:

number of minutes = 41760

number of value periods  $41760 / 15 = 2784$

For a 30 day month:

number of minutes = 43200

number of value periods  $43200 / 15 = 2880$

For a 31 day month:

number of minutes = 44640

number of value periods  $44640 / 15 = 2976$

In Excel files, on 23 hours day, the hour is not present:

96	29-03-2014	23:30	23:45	7,360,478	N	560,082	N	
97	29-03-2014	23:45	00:00	7,085,324	N	280,774	N	1
98	30-03-2014	00:00	00:15	6,991,489	N	0	N	2
99	30-03-2014	00:15	00:30	6,782,802	N	610,176	N	
00	30-03-2014	00:30	00:45	6,464,641	N	804,201	N	
01	30-03-2014	00:45	01:00	6,337,327	N	800,291	N	
02	30-03-2014	01:00	01:15	6,170,427	N	824,727	N	
03	30-03-2014	01:15	01:30	6,160,408	N	815,686	N	
04	30-03-2014	01:30	01:45	6,175,070	N	808,844	N	
05	30-03-2014	01:45	03:00	6,031,384	N	810,554	N	
06	30-03-2014	03:00	03:15	6,000,350	N	774,388	N	
07	30-03-2014	03:15	03:30	5,902,849	N	766,813	N	

In Excel files, on 25 hours day, the hour is present 2 times with an asterisk\*

## Appendix A. Glossary of terms

### Client

A company that holds a contract with Elia, which entitles the latter to metering messages. The messages received depend on the market "roles" that the client has. One client may perform several roles. A client receives metering messages for each of its market roles.

### Injection

Energy (produced by a producer) that is injected into the Elia grid

### Non-regulated metering

A message containing specific metering data requested by a client and defined in a contract. This one can contain values for quantities other than power.

### Offtake

Consumption of energy by a client connected to the Elia Grid

### PBO

"Perte de Bouclage" or "Clearing difference" between 2 quantities. For example the difference between the Elia Infeed on a distribution point and the sum of all offtake by the DGOs at this distribution point.

### Protocol

A set of rules governing the format of messages that are exchanged between computers

### Receiver

The recipient of a metering message

### Region

A region within Belgium that is controlled by a specific regulator

### Role

A function executed by a client, as defined in a contract. See section "1.2.1 Market roles " p 14

### Schedule

The series of values contained in a metering message. A schedule contains values for each day of a month. The time is indicated by the value of the duration field which is given in minutes.

### Sender

Party who sends a metering message

### Source

The provider of the metering data

### Validation

This is the process whereby the quantities referred to in a message are deemed to be correct. See section "1.2.3 Message validity " p 17

### Volt-Amperes-Reactive

Unit of reactive power (VAR)

### Watt

Unit of active power (W)

## Appendix B. List of tables

Table 1 Message delivery frequency.....	23
Table 2 CSV Access Point [header] fields.....	103
Table 3 CSV Access Point [data] fields .....	103
Table 4 CSV Access Point [schedule] fields .....	105
Table 5 CSV Metering Point [header] fields .....	106
Table 6 CSV Metering Point message [data] fields .....	106
Table 7 CSV Metering Point message [schedule] fields .....	108
Table 8 CSV CDS Loop Losses (PBO) [header] fields .....	110
Table 9 CSV CDS Loop Losses (PBO)message [data] fields .....	110
Table 10 CSV PBO message [schedule] fields.....	111
Table 11 CSV Infeed TSO per substation <header> fields.....	113
Table 12 CSV Infeed TSO per substation <data> fields .....	113
Table 13 CSV Infeed TSO per substation <schedule> fields .....	114
Table 14 CSV Infeed TSO per substation and per supply bay <header> fields .....	116
Table 15 CSV Infeed TSO per substation and per supply bay <data> fields .....	116
Table 16 CSV Infeed TSO per substation and per supply bay <schedule> fields .....	118
Table 17 CSV GEMP [header] fields.....	119
Table 18 CSV GEMP [dataG] fields.....	120
Table 19 CSV GEMP [dataR] fields .....	121
Table 20 CSV GEMP [dataS] fields .....	121
Table 21 CSV GEMP [schedule] fields .....	123
Table 22 CSV Imbalance [header] fields.....	124
Table 23 CSV Imbalance message [data] fields .....	124
Table 24 CSV Imbalance message [schedule] fields.....	126
Table 25 CSV Transfer of Energy (ToE) Delivered volumes [header] fields .....	127
Table 26 CSV Transfer of Energy (ToE) Delivered volumes message [data] fields .....	127
Table 27 CSV Transfer of Energy (ToE) delivered volumes message [schedule] fields.....	129
Table 28 CSV Real-Time DGO Allocation [header] fields .....	131
Table 29 CSV Real_Time DGO Allocation message [data] fields .....	131
Table 30 CSV Real_Time DGO Allocation message [schedule] fields .....	133
Table 31 XML <header> element for Access Point messages.....	135
Table 32 XML <data> element for Access Point messages .....	135
Table 33 XML <header> element for Metering Point messages.....	136
Table 34 XML <data> element for Metering Point messages .....	137
Table 35 XML headers elements for PBO messages.....	139
Table 36 XML <data> element for CDS Loop Losses (PBO) messages .....	140
Table 37 XML CDS Loop Losses (PBO) Time Series component and related data .....	140
Table 38 XML CDS PBO Time Series component and related data .....	140
Table 39 XML <Point> element for PBO messages.....	141
Table 40 XML <header> element for Infeed TSO per <b>substation</b> messages .....	142

Table 41 XML <data> element for Infeed TSO per substation messages.....	143
Table 42 XML <header> element for Infeed TSO per substation and per supply bay messages ..	144
Table 43 XML <data> element for Infeed TSO per substation and per supply bay messages .....	144
Table 44 XML <header> element for ARPGemp elements .....	146
Table 45 XML <data> element for ARPGemp elements.....	146
Table 46 XML <header> element for ARPRRegionGemp elements.....	147
Table 47 XML <data> element for ARPRRegionGemp elements .....	148
Table 48 XML <header> element for ARPSupplierGemp elements.....	149
Table 49 XML <data> element for ARPSupplierGemp elements .....	149
Table 50 XML headers elements for Imbalance messages .....	152
Table 51 XML <data> element for Imbalance messages.....	152
Table 52 XML Time Series Imbalance component and related data .....	155
Table 53 XML period components and related data .....	155
Table 54 XML <point> element for Imbalance messages.....	156
Table 55 XML header elements for Transfer of Energy (ToE) delivered volumes messages .....	158
Table 56 XML Time Series element for Transfer of Energy (ToE) delivered volumes messages....	159
Table 57 XML Time Series Business ID element possible values and related data for Transfer of Energy (ToE) delivered volumes message.....	159
Table 58 XML Time Series period and related data for Transfer of Energy (ToE) delivered volumes message .....	160
Table 59 XML <point> element for Transfer of Energy (ToE) delivered volumes messages.....	161
Table 60 XML header elements for Imbalance messages .....	163
Table 61 XML <data> element for Imbalance messages.....	164
Table 62 XML Time Series component and related data .....	164
Table 63 XML Period elements and related data .....	165
Table 64 XML Point element for Imbalance messages.....	165
Table 65 XML headers elements for DGOBP messages .....	167
Table 66 XML <data> element for DGOBP messages .....	168
Table 67 XML DGOBP Time Series component and related data .....	168
Table 68 XML Time Series <Period> component for DGOBP messages .....	169
Table 69 XML Point element for DGOBP messages .....	171
Table 70 XML headers elements for Delta TS messages.....	173
Table 71 XML <data> element for DeltaTS messages .....	174
Table 72 XML DeltaTS component and related data .....	174
Table 73 XML <point> element for Delta TS messages.....	176
Table 74 XML headers elements for Delta DGO Exchanges (DGO2DGO) messages.....	178
Table 75 XML <data> element for Delta DGO Exchanges (DGO2DGO) messages .....	179
Table 76 XML Delta DGO Exchanges (DGO2DGO) component and related data.....	179
Table 77 XML <point> element for Delta DGO Exchanges (DGO2DGO) messages.....	181
Table 78 XML headers elements for DGO Loop losses (DGO PBO) messages.....	184
Table 79 XML <data> element for DGO Loop Losses (DGO PBO) messages .....	184
Table 80 XML DGO Loop Losses (DGO PBO) Time Series component and related data .....	185

Table 81 XML Time Series component and related data for DGO Loop Losses message.....	185
Table 82 XML <Point> element for DGO Loop losses ( DGO PBO) messages .....	186
Table 83 XML headers elements for DGO Reactive Area and Supply Bay metering messages .....	188
Table 84 XML <Timeseries> element for 'DGO Reactive Area and Supply Bay' metering messages .....	189
Table 85 XML Time Series component and related data for 'DGO Reactive Area and Supply Bay' .....	189
Table 86 XML Time Series power type and related data for 'DGO Reactive Area and Supply Bay' .....	189
Table 87 XML Period element for DGO Reactive Area and Supply Bay message .....	190
Table 88 XML <point> element for DGO Reactive Area and Supply Bay metering messages .....	191
Table 89 XML Party element contents .....	192
Table 90 XML Point element contents.....	192
Table 91 XML Schedule element contents .....	194
Table 92 Data types in XML formatted messages.....	195
Table 93 Excel Access Point header fields .....	197
Table 94 Excel Access Point column metering reference .....	198
Table 95 Excel Access Point columns cells.....	199
Table 96 Excel CDS Loop Losses (PBO) message - header fields.....	201
Table 97 Excel CDS Loop Losses (PBO) message - column metering reference .....	202
Table 98 Excel CDS Loop Losses (PBO) message - [schedule] fields.....	203
Table 99 Excel Infeed TSO per substation header fields.....	204
Table 100 Excel GEMP header fields.....	207
Table 101 Excel Access Point header fields .....	208
Table 102 Excel Imbalance column metering reference .....	209
Table 103 Excel Imbalance [schedule] fields .....	209
Table 104 Excel 'Transfer of Energy (ToE) delivered volumes' header fields .....	210
Table 105 Excel 'Transfer of Energy (ToE) delivered volumes' message – Sheet 'Summary' – columns references .....	212
Table 106 Excel 'Transfer of Energy (ToE) delivered volumes' message – Sheet 'Summary' – list of components.....	212
Table 107 Excel 'Transfer of Energy (ToE) delivered volumes)' message – Sheet 'Summary' – Columns values.....	212
Table 108 Excel 'Transfer of Energy (ToE) delivered volumes' message – Sheet 'Detail' – Columns values.....	214
Table 109 Excel 'Transfer of Energy (ToE) delivered volumes' message – Sheet 'Detail' – Components .....	214
Table 110 Excel DGO Loop losses (DGO PBO) header fields .....	215
Table 111 Excel 'DGO Loop losses (DGO PBO)' message – Sheet 'Summary' – columns references .....	216
Table 112 Excel 'DGO Loop losses (DGO PBO)' message – Sheet 'Summary' – Columns values ..	217
Table 113 Excel Delta TS header fields.....	219
Table 114 Excel 'Delta TS' message – Sheet 'Summary' – columns references .....	221
Table 115 Excel 'Delta TS' message – Sheet 'Summary' – Columns values .....	221
Table 116 Excel DGO2DGO header fields.....	224
Table 117 Excel 'DGO2DGO' message – Sheet 'Summary' – columns references .....	225

---

Table 118 Excel 'DGO2DGO' message – Sheet 'Summary' – Columns values.....	226
Table 119 Excel Access Point header fields .....	229
Table 120 Excel Imbalance column metering reference .....	229
Table 121 Excel Imbalance [schedule] fields .....	230
Table 122 Excel DGO Border Point and Supply Bay (DGOBP)' header fields.....	231
Table 123 Excel 'DGO Border Point and Supply Bay (DGOBP)' message – Sheet 'Border Point' – columns references .....	232
Table 124 Excel 'DGO Border Point and Supply Bay (DGOBP)' - Sheet 'Border Point' – Columns values.....	233
Table 125 Excel DGO Reactive Area header fields .....	236
Table 126 Excel 'DGO Reactive Area' message – Sheet 'Reactive Area' –columns references.....	237
Table 127 Excel 'DGO Reactive Area' Columns values .....	238



## Appendix C. List of Figures

Figure 1 Direction of power flow with the Elia grid .....	11
Figure 2 Averaged 15 minutes (quarter-hour) values .....	12
Figure 3 Non-compensated values .....	12
Figure 4 Compensated values .....	13
Figure 5 Gross production and consumption values.....	14
Figure 6 Daily delivery of metering messages .....	18
Figure 7 Regular deliveries of monthly messages.....	18
Figure 8 Access Points .....	25
Figure 9: CDS Loop losses (PBO) directions .....	37
Figure 10 Infeed TSO per substation.....	43
Figure 11 Infeed TSO per substation and per supply bay .....	47
Figure 12 GEMP messages.....	51
Figure 13: Balance perimeter.....	56
Figure 14: Linear regression model for Real-Time DGO Allocation Estimation .....	75
Figure 15: DGO Loop losses (DGO PBO) directions .....	93
Figure 16 Sheet in a CSV Access Point message .....	196
Figure 17 Access Point message header .....	197
Figure 18 CSV Access Point message – columns header .....	198
Figure 19 Fields in an Excel Metering Point message .....	199
Figure 20 Fields in an Excel CDS Loop Losses (PBO) message .....	200
Figure 21 Excel CDS Loop Losses (PBO) message - header .....	201
Figure 22 Excel CDS Loop Losses (PBO)message –columns header.....	202
Figure 23 Fields in a Excel Infeed TSO per substation message .....	203
Figure 24 Excel Infeed TSO per substation message-header .....	203
Figure 25 Columns in a Excel Infeed TSO per substation and per supply bay message .....	205
Figure 26 Excel GEMP sheet.....	206
Figure 27 Excel GEMP header.....	206
Figure 28 Fields in an Excel Imbalance message.....	207
Figure 29 Excel Imbalance message –header .....	207
Figure 30 Excel Imbalance message –columns header .....	208
Figure 31 Transfer of Energy (ToE) delivered volumes - Excel sheet 'Summary' –header .....	210
Figure 32 Excel 'Transfer of Energy (ToE) delivered volumes' message – Sheet 'Summary' – columns header .....	211
Figure 33 Excel 'Transfer of Energy (ToE) delivered volumes' message – Sheet 'Detail' –columns header .....	213
Figure 34 DGO Loop losses (DGO PBO) - Excel sheet 'Summary' –header.....	215
Figure 35 Excel 'DGO Loop losses (DGO PBO)' message – Sheet 'Summary' – columns header ..	216
Figure 36 Excel 'DGO Loop losses (DGO PBO)' message – Sheet 'Detail' –columns header .....	217
Figure 37 Delta TS - Excel sheet 'Summary' –header .....	219
Figure 38 Excel 'Delta TS' message – Sheet 'Summary' – columns header.....	220

Figure 39 Excel 'Delta TS' message – Sheet 'Detail' –columns header .....	221
Figure 40 DGO2DGO - Excel sheet 'Business Summary' –header .....	223
Figure 41 Excel 'DGO2DGO' message – Sheet 'Summary' –columns header .....	224
Figure 42 Excel 'DGO Reactive Area' message – Sheet 'Supply Bay' –columns header .....	226
Figure 43 Fields in an Real-Time DGO Allocation message .....	228
Figure 44 Excel Imbalance message -header .....	228
Figure 45 Excel Real-Time DGO Allocation message –columns header .....	229
Figure 46 Excel sheet 'DGO Border Point and Supply Bay (DGOBP)' – header.....	230
Figure 47 Excel 'DGO Border Point and Supply Bay (DGOBP)' message – Sheet 'BorderPoint' – columns header .....	231
Figure 48 Excel 'DGO Border Point and Supply Bay (DGOBP)' message – Sheet 'Supply Bay' – columns header .....	233
Figure 49 Excel sheet 'Reactive Area' –header.....	235
Figure 50 Excel 'DGO Reactive Area' message – Sheet 'Reactive Area' –columns header .....	236
Figure 51 Excel 'DGO Reactive Area' message – Sheet 'Supply Bay' –columns header.....	238
Figure 52 Delivery of metering data via the EVMSB2C web site .....	240
Figure 53 Folder structure on the Elia FTP client .....	241
Figure 54 Private and public key images.....	242
Figure 55 Private and public key on computers .....	242

## Appendix D. List of Examples

Example 1 CSV Access Point message.....	26
Example 2 XML Access Point message root .....	27
Example 3 XML Access Point message <header> .....	27
Example 4 XML Access Point message <data-list>.....	27
Example 5 XML Access Point message <data> .....	27
Example 6 Excel Access Point message sheet.....	28
Example 7 CSV Metering Point message.....	30
Example 8 XML Metering Point message.....	31
Example 9 Excel (XLSX) Metering Point message.....	32
Example 10 CSV CDS Access Point message .....	34
Example 11 XML CDS Access Point message root .....	35
Example 12 XML CDS Access Point message <header> .....	35
Example 13 XML CDS Access Point message <data-list> .....	35
Example 14 XML CDS Access Point message <data> .....	35
Example 15 Excel (XLSX) CDS Access Point message.....	36
Example 16 CSV CDS Loop losses (PBO) message .....	39
Example 17 XML CDS Loop losses (PBO) message root .....	41
Example 18 XML CDS Loop Losses (PBO) message header .....	41
Example 19 XML CDS Loop losses (PBO) message TimeSeries .....	42
Example 20 Excel CDS Loop Losses (PBO) message sheet.....	42
Example 21 CSV Infeed TSO per substation message.....	44
Example 22 XML Infeed TSO per substation message root.....	45
Example 23 XML Infeed TSO per substation message <header> .....	45
Example 24 XML Infeed TSO per substation message <data-list> .....	45
Example 25 XML Infeed TSO per substation message <data> .....	45
Example 26 Excel (XLSX) Infeed TSO per substation message .....	46
Example 27 CSV Infeed TSO per substation and per supply bay message.....	48
Example 28 XML Infeed TSO per substation and per supply bay message root .....	49
Example 29 XML Infeed TSO per substation and per supply bay message <header>.....	49
Example 30 XML Infeed TSO per substation and per supply bay message <data-list> .....	49
Example 31 XML Infeed TSO per substation and per supply bay message <data> .....	49
Example 32 Excel (XLSX) Infeed TSO per substation and per supply bay message.....	50
Example 33 CSV Global Elia Metered Position (GEMP) message .....	53
Example 34 XML ARPALLGemp message root.....	54
Example 35 XML GEMP message <ARPGemp> .....	54
Example 36 XML GEMP message <header> .....	54
Example 37 XML GEMP message <data-list> .....	55
Example 38 Excel (XLSX) Global Elia Metered Position (GEMP) message.....	55
Example 39 CSV Imbalance message.....	66
Example 40 XML Imbalance message root.....	68

Example 41 XML Imbalance message header .....	68
Example 42 XML Imbalance message TimeSeries .....	69
Example 43 Excel Imbalance message sheet.....	69
Example 44 CSV Transfer of Energy (ToE) delivered volumes message .....	71
Example 45 XML Transfer of Energy (ToE) delivered volumes message root.....	72
Example 46 XML Transfer of Energy (ToE) delivered volumes) message header .....	73
Example 47 XML Transfer of Energy (ToE) delivered volumes message TimeSeries.....	73
Example 48 Excel Transfer of Energy (ToE) delivered volumes message 'Detail' sheet.....	74
Example 49 CSV Real-Time DGO Allocation message .....	76
Example 50 XML Real-Time DGO Allocation message root .....	77
Example 51 XML Real-Time DGO Allocation message header .....	78
Example 52 XML Real-Time DGO Allocation message TimeSeries.....	79
Example 53 Excel Real-Time DGO Allocation sheet .....	79
Example 54 XML DGOBP message root .....	82
Example 55 XML DGOBP message header .....	82
Example 56 XML DGOBP message TimeSeries.....	83
Example 57 Excel DGO Border Point and Supply Bay (DGOBP) message 'Detail' sheet .....	83
Example 58 XML Delta TS message root.....	86
Example 59 XML Delta TS message header.....	87
Example 60 XML DeltaTS message TimeSeries.....	87
Example 61 Excel DeltaTS message 'Detail' sheet.....	88
Example 62 XML Delta DGO Exchanges (DGO2DGO) message root.....	90
Example 63 XML Delta DGO Exchanges (DGO2DGO) message message header and TimeSeries ...	92
Example 64 Excel DGO2DGO message 'Detail' sheet.....	92
Example 65 XML DGO Loop losses (DGO PBO) message root .....	96
Example 66 XML DGO Loop Losses (DGO PBO) message header.....	96
Example 67 XML DGO Loop losses (DGO PBO) message TimeSeries .....	97
Example 68 Excel DGO Loop Losses message 'Summary' sheet.....	98
Example 69 XML message root.....	99
Example 70 XML DGO Reactive Area and Supply Bay metering message header.....	99
Example 71 XML Imbalance message TimeSeries .....	100
Example 72 Excel Imbalance message sheet.....	100
Example 73 Fields in a CSV Access Point message.....	102
Example 74 Fields in a CSV Metering Point message .....	105
Example 75 Fields in a CSV CDS Loop Losses (PBO)message .....	109
Example 76 Fields in a CSV Infeed TSO per substation message .....	112
Example 77 Fields in a CSV Infeed TSO per substation and per supply bay message.....	115
Example 78 Fields in a CSV GEMP message .....	119
Example 79 Fields in a CSV Imbalance message.....	123
Example 80 Fields in a CSV Transfer of Energy (ToE) Delivered volumes message.....	126
Example 81 Fields in a CSV Real-Time DGO Allocation message .....	130



Example 82 Example of PBO message..... 138

Example 83 CDS PBO Time Series element ..... 139

Example 84 Example of DGO Loop losses ( DGO PBO) message..... 182

Example 85 PBO Time Series element..... 184

Example 86 XML Party elements ..... 191

Example 87 XML <schedule> element ..... 193

# Appendix E. Index

[end] 27, 31, 35, 54, 67, 72, 103, 104, 106, 107, 110, 120, 125, 128, 131	XML format ..... 42, 138
'DGO Reactive Area and Supply Bay metering'	CDSO ..... 8
XML format ..... 100	CDSO ..... 16
<b>62325-451-4</b> 42, 69, 73, 78, 82, 87, 91, 97, 100, 138, 152, 158, 164, 168, 174, 179, 184	CDSPBO metering..... 17
Access Contract Holder ..... 8	Client role..... 250
definition ..... 15	Clients ..... 15
Access point	ACH ..... 15
CSV format ..... 103, 135	BRP ..... 16
description ..... 26, 70	DGO ..... 16
Excel format ..... 10, 198	DSO ..... 16
XLSX format ..... 29, 198	Grid User ..... 15
XML format ..... 135	MRCO ..... 16
Access points	Supplier ..... 16
definition ..... 16	Closed Distribution System ..... 34
recipients..... 26, 76	Closed Distribution System ..... 8
XML format ..... 28	Closed Distribution System Access Point messages
ACH..... 8	CSV format ..... 35
definition ..... 15	recipients ..... 34
Active power ..... 8	XLSX format..... 37
Balance Service provider ..... 16	XML format ..... 36
Balance Service Provider messages	Closed Distribution System Access Point messages
recipients..... 29	Excel format ..... 37
BRP ..... 8	Closed Distribution System Access Point metering ..... 34
definition ..... 16	Compensated ..... 8
Brussels ..... 52	Compensation ..... 13
BSP ..... 8	CSV ..... 8
BSP ..... 16	'DGO Reactive Area and Supply Bay metering'
BSP messages	messages..... 100
recipients..... 29	Access Point messages ..... 27, 103
CDS ..... 8	CDS PBO messages ..... 110
CDS ..... 34	Closed Distribution System Access Point messages .. 35
CDS Access Point ..... 17	DGO Allocation messages ..... 77
CDS Access Point messages	file format ..... 103
CSV format ..... 109	GEMP messages ..... 53, 119
CDS metering..... 17	Imbalance messages ..... 67, 124
CDS Operator ..... 16	Infeed TSO per substation..... 45
CDS PBO	Infeed TSO per substation and per supply bay ..... 49
description ..... 38	Infeed TSO per substation and per supply bay messages ..... 116
CDS PBO messages	Infeed TSO per substation messages ..... 113
CSV format ..... 110	Metering point messages..... 31, 106, 109
	PBO messages ..... 40, 110

Real-Time DGO Allocation messages.....	76, 130	DGO Reactive Area and Supply Bay (DGO RA)	
Transfer of Energy (ToE) delivered volumes messages		Description .....	99
.....	72, 127	DGO Reactive Area and Supply Bay metering messages	
CSV CDS Access Point messages.....	109	XLSX format.....	236
Daily delivered messages .....	18	DGO Reactive Area and Supply Bay metering messages	
Date format.....	247	messages	
Daylight saving .....	13, 248	Excel format .....	236
Delivered messages		Direction	
clients .....	20	of power.....	12
Frequency.....	20	Distribution Grid Operator .....	8, 17, 18, 44, 48
Delta DGO Exchanges (DGO2DGO)		DSO .....	8
XML format .....	92, 93, 179	definition.....	16
Delta DGO Exchanges (DGO2DGO) metering messages		Duration	
XLSX format .....	225	definition.....	13
Delta DGO Exchanges (DGO2DGO) metering messages		Estimated values .....	14
messages		EVMSB2C.....	8
Excel format .....	225	Excel .....	10
Delta DGO Exchanges (DGO2DGO) report		Access Point messages.....	29, 32, 198
Description .....	89	Closed Distribution System Access Point messages ..	37
Delta TS report .....	85	Delta DGO Exchanges (DGO2DGO) metering messages	
DeltaTS		.....	93, 225
XML format .....	87, 88, 174	Delta TS (DTS) metering messages.....	89, 220
DGO .....	8	DGO Allocation messages .....	80, 230
definition .....	16	DGO Border Point and Supply Bay (DGOBP) metering	
DGO Allocation		messages.....	232
XLSX format.....	80	DGO Loop losses (DGO PBO) metering messages ...	216
XML format .....	78	DGO Reactive Area and Supply Bay metering messages	
DGO Border Point and Supply Bay (DGOBP)		.....	101, 236
XML format .....	83, 84, 168	file format .....	198
DGO Border Point and Supply Bay (DGOBP) metering		GEMP messages .....	56, 208
messages		Imbalance messages .....	58, 70, 99, 101, 209
XLSX format.....	232	Infeed TSO per substation.....	47
DGO Border Point and Supply Bay (DGOBP) metering		Infeed TSO per substation and per supply bay .....	51
messages messages		Infeed TSO per substation and per supply bay	
Excel format .....	232	messages.....	207
DGO Border Point and Supply Bay metering		Infeed TSO per substation messages .....	205
description .....	81	Metering point messages.....	34, 201
DGO Connection Point .....	8, 48	PBO messages .....	43, 98, 99, 202
DGO Loop Losses (DGO PBO)		Real-Time DGO Allocation messages .....	76, 230
XML format .....	97, 183	Transfer of Energy (ToE) delivered volumes messages	
DGO Loop Losses (DGO PBO) report		.....	75, 211
Description .....	94	Excel 2010	
		file format .....	198



Excel format .....	10	CSV format .....	49, 116
Federal .....	52	Excel format .....	51, 207
File names		XLSX format.....	51, 207
EVMSB2C.....	245	XML format .....	144
SFTP.....	246	Infeed TSO per substation messages .....	17, 44
Flanders.....	52	CSV format .....	45, 113
Formats .....	19	Excel format .....	47, 205
GEMPs .....	52	XLSX format.....	47, 205
CSV format .....	53, 119	XML format .....	46, 50, 142
example.....	53	Infeed TSO per substation messages and per connection .....	17
Excel format .....	56, 208	Injection .....	12, 250
recipients.....	53, 70	Invalid data.....	19
XLSX format.....	56, 208	ISO 8601.....	247
XML format .....	55, 146	Messages.....	1
Global Elia Metered Position.....	9	Access points.....	16
Grid User .....	9	CDS Access Point .....	17
definition .....	15	CDSPBO .....	17
Gross .....	9, 15	formats.....	19
GU .....	9	Imbalance.....	17
definition .....	15	Infeed TSO per substation.....	17, 44
<b>IEC 42, 69, 73, 78, 82, 87, 91, 97, 100, 138, 152, 158, 164, 168, 174, 179, 184</b>		Infeed TSO per substation and per connection.....	17
Imbalance		Infeed TSO per substation and per supply bay .....	48
description .....	57	Metering point .....	17, 30
XLSX format.....	70, 101	Names .....	245
XML format .....	69	Service Point .....	17
Imbalance messages		types.....	16
Excel format .....	209	Messages names .....	245
XLSX format.....	209	Metering Contract Holder .....	9, 16, 245
XML format .....	79, 80, 152, 166, 167	metering point .....	17
Imbalance metering .....	17	Metering point messages.....	30
Imbalance values		CSV format .....	31, 106, 124
recipients.....	58	Excel format .....	201
Imbalance values		XLSX format.....	32, 201
recipients.....	39	XML format .....	32, 137
Imbalance values		Metering Point messages	
XLSX format.....	70	recipients .....	30
Imbalance values		Metering point metering.....	17
XLSX format.....	101	Metering type .....	15
Inexact.....	14	Monthly validated delivered messages.....	19
Infeed TSO per substation and per supply bay messages .....	48	MRCO .....	9

definition .....	16	Reactive Area and Supply Bay messages	
National summation.....	121	XML format .....	188
Net.....	9, 15	Real-Time DGO Allocation	
Non-compensated values.....	13	description .....	76
Normal .....	14	Real-Time DGO Allocation messages	
Off take.....	12, 250	XLSX format.....	230
PBO.....	9	XML format .....	76, 79, 164
XLSX format .....	43, 98	Real-Time DGO Allocation messages	
XML format .....	41, 96	Excel format .....	230
PBO messages		Receiver .....	250
CSV format .....	110	Region .....	250
PBO messages		Regional summation .....	121
Excel format .....	202	per supplier .....	122
PBO messages		Regions.....	52
XLSX format.....	202	Regulators .....	52
PBO values		Schedule.....	250
XLSX format.....	43, 98	definition.....	13
Period.....	13	SDR messages	
Power .....	9	recipients .....	29
Active.....	12	Sender .....	250
Compensated .....	13	Service point .....	29
Consumption .....	12	Service Point .....	9, 17
Direction.....	12	Service Point messages	
Estimated values .....	14	CSV format .....	106
Gross .....	15	Service point metering.....	29
Metering type.....	15	SFTP.....	243
Net.....	15	Source .....	250
Production.....	12	SP9	
Quality.....	14	SP29	
Reactive.....	12	SP metering.....	17
Units .....	14	Standard...8, 42, 69, 73, 78, 82, 87, 91, 97, 100, 138, 152,	
Valid .....	18	158, 164, 168, 174, 179, 184	
Value periods .....	13	Substation .....	44, 48
PROD .....	9	Substitute.....	14
PROD .....	16	Summer time .....	13
Producer.....	16	SUP.....	9, 16
Producer.....	9	Supplier .....	9
Protocols .....	19	definition.....	16
Publication day.....	18	Time format .....	247
Quality .....	14	Transfer of Energy (ToE) delivered volumes	
Quarter hour periods .....	13	XML format .....	73, 74, 158

Transfer of Energy (ToE) delivered volumes messages	Closed Distribution System Access Point messages .. 36
CSV format ..... 127	Delta DGO Exchanges (DGO2DGO) messages .... 92, 93, 179
Units ..... 14	DeltaTS messages.....87, 88, 174
non-power..... 30	DGO Allocation messages ..... 78
Validity ..... 18	DGO Border Point and Supply Bay (DGOBP) messages .....83, 84, 168
Value period ..... 248	DGO Loop Losses (DGO PBO) messages..... 97, 183
Value periods ..... 13	GEMP messages ..... 55, 146
VAR..... 250	Imbalance messages .....69, 100, 152, 164
Volt-Amperes Reactive..... 12	Infeed TSO per substation and per supply bay messages..... 50, 144
Volt-Amperes-Reactive ..... 250	Infeed TSO per substation messages ..... 46, 142
Wallonia ..... 52	Metering point messages.....31, 32, 34, 39, 137
Watt ..... 12, 250	PBO messages ..... 41, 96
Winter time ..... 13	Reactive Area and Supply Bay messages..... 100, 188
xEIN105 ..... 44	Real-Time DGO Allocation messages .....76, 79, 164
XLSX..... 10	Transfer of Energy (ToE) delivered volumes messages .....73, 74, 158
Access Point messages ..... 198	XML Schema..... 135
Closed Distribution System Access Point messages .. 37	XSD..... 135
Delta DGO Exchanges (DGO2DGO) metering messages ..... 93, 225	
Delta TS (DTS) metering messages ..... 89, 220	
DGO Border Point and Supply Bay (DGOBP) metering messages ..... 232	
DGO Loop losses (DGO PBO) metering messages ... 216	
DGO Reactive Area and Supply Bay metering messages ..... 101, 236	
file format..... 198	
GEMP messages ..... 56, 208	
Imbalance messages..... 70, 209	
Infeed TSO per substation ..... 47	
Infeed TSO per substation and per supply bay..... 51	
Infeed TSO per substation and per supply bay messages..... 207	
Infeed TSO per substation messages..... 205	
Metering point messages ..... 32, 34, 201	
PBO messages ..... 43, 99, 202	
Real-Time DGO Allocation messages..... 76, 230	
Transfer of Energy (ToE) delivered volumes messages ..... 75, 211	
XML ..... 10	
'DGO Reactive Area and Supply Bay metering' messages ..... 99, 100	
Access Point messages ..... 28, 135	
CDS PBO messages ..... 42, 138	

