

Description and Use of Metering Messages transmitted by Elia for the Grid User (GU)

The purpose of this document is to explain how to access, understand and use messages containing metering data transmitted by Elia. It describes the content of the messages, how they are transmitted, the type of data transmitted and how this data can be implemented in client's business applications.

This manual should be read by:

- Metering operational staff who need to understand the contents of metering messages
- IT Developers, who need to use the message content in the implementation of custom applications

Version: 1.3.

Publication: N/A

Contact email address in case of business or technical issues: metering.services@elia.be

Elia hereby excludes all liability (whether in contract, tort, delict, quasi-delict, statute or strict liability) for any type of damage, direct or indirect, consequential, or of any other nature, resulting of the use of this document

For the avoidance of doubt, Elia does not accept any liability for the acts or omissions of the users of this document.

Table of Contents

Introduction	6
Chapter 1 Metering Messages	7
1.1. Messages	7
1.1.1. Market roles	7
1.1.2. Message types	8
1.1.3. Message validity.....	9
1.1.4. Message delivery.....	10
1.1.5. Accessing messages – protocols.....	11
1.1.6. Accessing messages – formats.....	11
1.1.7. Message formats and protocols independency	11
1.1.8. Regulated messages & message delivery frequency	11
1.2. Related documents	15
Chapter 2 Understanding messages	16
2.1. Access Point	16
2.1.1. CSV Access Point.....	17
2.1.2. XML Access Point.....	22
2.1.3. Excel (XLSX) Access Point	24
2.2. SubAccess Delivery Point.....	29
2.2.1. Message content and structure	29
2.3. Metering Point.....	30
2.3.1. CSV Metering Point message.....	31
2.3.2. XML Metering Point message	36
2.3.3. Excel (XLSX) Metering Point message	37
2.4. CDS Access Point	38
2.4.1. CSV CDS Access Point message	39
2.4.2. XML CDS Access Point message structure.....	41
2.4.3. Excel CDS Access Point message structure	42
2.5. Offshore Interconnection Point	43
2.6. GEMP	44
2.6.1. CSV GEMP	46
2.6.2. XML GEMP	52
2.6.3. Excel GEMP	58
2.7. Imbalance	60
2.7.1. Imbalance components	61
2.7.2. Imbalance components criteria's	65
2.7.3. Imbalance components added parameters.....	68
2.7.4. Distribution grid area codes.....	70
2.7.5. Closed Distribution System area codes.....	71
2.7.6. CSV Imbalance Value.....	72

2.7.7. XML Imbalance	76
2.7.8. Excel Imbalance Value	84
2.8. Transfer of Energy (ToE) Delivered volumes	88
2.8.1. Transfer of Energy (ToE) delivered volumes Components	88
2.8.2. CSV Transfer of Energy (ToE) delivered volumes Value	89
2.8.3. XML Transfer of Energy (ToE) delivered volumes value	93
2.8.4. Excel Transfer of Energy (ToE) delivered volumes value	100
2.9. Real-Time DGO Allocation.....	108
2.9.1. Real-Time DGO Allocation components.....	109
2.9.2. CSV Real-Time DGO Allocation	109
2.9.3. XML Real-Time DGO Allocation	112
2.9.4. Excel (XLSX) Real-Time DGO Allocation.....	115
Chapter 3 XML format messages	116
3.1. Reference XSD	116
3.2. XML elements	117
3.2.1. Party elements.....	117
Point elements	118
Schedule elements	119
3.3. Data types.....	122
Chapter 4 Accessing messages.....	123
4.1. Characteristics of the different channels	123
4.2. The eVMS B2C website.....	123
4.3. The EPIC Portal	124
4.4. SFTP server	124
4.4.1. Use of certificates: Public key – private key	126
4.5. Metering messages name	127
4.5.1. eVMS B2C / EPIC message file names	127
FTP Metering message file names	128
4.6. Time formatting and Daylight saving.....	130
4.6.1. Time and date formatting	130
4.6.2. Daylight saving	131
Value periods in a message	132
Appendix A. Glossary of terms	133

Abbreviation	Description
ACH	Access Contract Holder
aFRR	automatic Frequency Restoration Reserve
AP	Access Point
BRP	Balance Responsible Party Note: the former term "ARP" (Access Responsible Party) is still used in some documents or file names
BRP _{O.I.}	Balance Responsible Party associated with an Offshore Interconnector
B2B	Business to Business
BSP	Balancing Service Provider (generic role)
CDS	Closed Distribution System
CDSO	Closed Distribution System Operator
CSV	Comma Separated Values
DGO	Distribution Grid Operator
DCP	DGO Connection Point
DP	Delivery Point
EAN	European Article Number
EIC	Energy Identification Code
EVMSB2C	Web site allowing to download the metering publications
FTP	File Transfer Protocol
GEMP	Global Elia Metered Position
GU	Grid User
MCH	Metering Contract Holder
PROD	Producer
mFRRDP _{su} (mFRRC _{ipu})	manual Frequency Restoration Reserve delivered by Delivery Points DP _{SU} (formerly known as CIPU units)
mFRRDP _{pg} (mFRRN _{onCipu})	manual Frequency Restoration Reserve delivered by Delivery Points DP _{PG} (formerly known as non CIPU units).
SDR	Strategic Demand Reserve

SP	SubAccess Delivery Point, also known as Submetering Delivery Point (Formerly called "Service Point")
SUP	Supplier
ToE	"Transfer of Energy" as introduced by the Law of 13 th of July 2017
TSO	Transmission System Operator (Elia in this document)
XLSX	Microsoft ® Excel format and file qualifier
XML	eXtensible Markup Language

Introduction

This document describes all aspects of metering data provided by Elia. This includes how to understand metering messages and how to access messages delivered via one of the protocols put at disposal by Elia.

This document serves four purposes:

- To provide clear understandable explanations of the data contained in metering messages. This information is for the use of operational staff, who need to understand message content and its application.
- To explain the use of the <https://evmsb2c.elia.be> web page to the operational staff.
- To provide reference information for IT Developers who need to build business applications for both accessing and using metering data. Especially to explain the use of the SFTP protocol, adopted for the transfer of messages from Elia to its clients.

This document is structured as follows:

Chapter 1 describes some of the concepts relating to metering messages, as well as the types of clients who can receive them. The terminology used in this chapter should be understood by both operational and development staff. For more information, see Metering Manual Concepts.

Chapter 2 contains general explanations of the contents of all message types. This information is aimed at the operational staff who need to understand message content. This Chapter contains also detailed information on all the message fields and are targeted more at developers who need to access this information for use in their own business applications.

Chapter 3, contain detailed information on the XML message fields and are targeted more at developers who need to access this information for use in their own business applications.

Chapter 4 explains how to access messages. It describes the different available protocols: it sets out the advantages of the use of the common communication protocol, which is of interest to all recipients, as well as detailed reference sections on the use of the protocol.

Chapter 1 Metering Messages

1.1. Messages

1.1.1. Market roles

This section lists each type of clients who have a contractual right to metering information. Clients have different market roles, and it is this role that determines the type of messages they receive. A client is identified as the "receiver" of the message.

Frequency delivery and messages received by the clients are defined in section "1.1.8 Regulated messages & message delivery frequency".

1.1.1.1. Grid User (GU)

A Grid User has signed a Connection Contract which grants the right to be connected to the Elia grid. For details on this type of contract, refer to the website Elia: <https://www.elia.be/en/customers/connection>.

1.1.1.2. Access Contract Holder (ACH)

An Access Contract Holder has a contract allowing offtake or injection of energy at (a) particular Access Point(s). The Access Contract Holder is the party who manages the Access Point and is not necessarily the same as the Grid User for that same point. For details on this type of contract, refer to the website Elia: <https://www.elia.be/en/customers/access>.

1.1.1.3. Balance Responsible Party (BRP)

A Balance Responsible Party is responsible for "nominating" the actual amounts of power injected or taken out of the Elia grid, and for maintaining the balance between injection and consumption into his balance perimeter.

Each Access Point must have a Balance Responsible Party associated with it. For details on this BRP role and on this type of contract, refer to the website Elia: <https://www.elia.be/en/electricity-market-and-system/role-of-brp>.

1.1.1.4. Supplier (SUP)

A Supplier provides energy that is injected into the grid. This must be done through a corresponding Balance Responsible Party.

1.1.1.5. Producer (PROD)

A Producer produces energy that is injected into the grid. This must be done through a Supplier.

1.1.1.6. Balancing Service provider (BSP) / Flexibility Service Provider (FSP)

The Balance Service provider (BSP) / Flexibility Service Provider (FSP) provides Elia with balancing/flexibility services or strategic reserves. This is a generic role given to the signatory of a balancing/flexibility service contract like an mFRR contract, DA/ID contract or SDR Contract.

1.1.1.7. Metering Contract Holder (MCH)

A Metering Contract Holder has a contract entitling the holder to receive specific (non-regulated) metering data at specific points. Such a contract is not necessary for clients listed above who will receive metering data as part of the regulatory requirement associated with the contracts they already hold with Elia. Any of the clients listed above can request additional non-regulated metering messages. This type of message is described in section "2.3 Metering Point" and the frequency delivery is defined in the Metering Contract. For details on this type of contract, refer to the website Elia: <https://www.elia.be/en/customers/metering/additional-metering-services>.

1.1.2. Message types

The type of messages a client receives depends on the nature of the contract that is held with Elia and the "role" of the client. An overview of the message type by role is available in section 1.1.8.

1.1.2.1. Access Point (AP)

These messages contain power flow values (aggregated metering data) at specific Access Points. These messages are described in more detail in section "2.1 Access Point".

Note: The Offshore Interconnection Point is a special Access Point.

1.1.2.2. SubAccess Delivery Point (SP)

These messages contain power flow values at specific SubAccess Delivery Point, also known as Submetering Delivery Point. The service delivered can be Strategic Demand Reserve (SDR), mFRR, DA/ID or other services provided to Elia within the framework of balancing, flexibility, or strategic reserves. These messages are described in more detail in section "2.2 SubAccess Delivery Point".

1.1.2.3. Metering Point (MP)

These messages can contain:

- Specific metering data requested by a client and defined in a metering contract. They can contain electric or non-electric data and refer to a specific Access Point.
- Metering data of an individual meter. Usually, these individual meters are used to calculate an aggregation like an Access Point, a SubAccess Delivery Point, etc.

A description can be found in more detail in section 2.3.

1.1.2.4. CDS Access Point (CDS AP)

These messages contain power transfer values at specific CDS Access Points (Access point into a Closed Distribution System). These messages are described in more detail in section 2.4.

1.1.2.5. Offshore Interconnection Point

These messages contain the power injected or taken off into/from the Elia Grid through the "Offshore Interconnection Point"

1.1.2.6. Global Elia Metered Position (GEMP)

These messages provide aggregated data destined to the BRP. The data is summed nationally over Belgium, over each regulated region and over each regulated region per Supplier. These messages are described in more detail in section 2.6.

1.1.2.7. Imbalance

These messages contain metering data destined to the BRP and contain the Imbalance of his perimeter for a given month. These messages are described in more detail in section 2.7.

1.1.2.8. Transfer of Energy (ToE) Delivered volume (mFRR Del)

These messages contain the volume delivered (only by DP_{PG} delivery points (former non CIPU) with a Transfer of Energy regime) by a BSP/FSP in the framework of the mFRR & DA/ID service. The former name of this type of publications was "mFRR Del". These messages are described in more detail in section 2.8.

Note: The former messages mFRR non CIPU (DP_{PG}) delivered volume (mFRR Del) are deprecated and are not published anymore.

1.1.2.9. RT DGO Allocation

These messages contain an estimate of the DGO Allocation destined to the BRP. These messages are described in more detail in section 2.9.

1.1.3. Message validity

The initial metering message contains non-validated data. This should not be confused with the quality of the data (See Section 1.1.3.1) – for even if all power values are labelled as normal (N) this does not yet mean that they are validated. The validity of the data applies to the complete set of values in the schedule. Data is validated by processes and checks carried out by Elia. When a message is validated, the values are guaranteed to be correct by Elia.

1.1.3.1. Quality

Power values can be measured, calculated, or estimated. Every power value in the message is assigned a quality label which can be one of the following:

- N (Normal)

This refers to normal measured values, usually determined by a single properly functioning meter.

- I (Inexact)

Power values may be labelled inexact for several reasons. It may be because there was a perceived problem with the meter, or that values were calculated from combined measurements from several meters, one of which was inexact.

- S (Substitute)

If no measurement is available, an estimated value is used.

Note that the quality of the measured data should not be confused with the *validity* of the message.

1.1.4. Message delivery

The power values transferred over the quarter hour periods are delivered regularly; daily and/or monthly. This pattern applies to all regulated messages.

1.1.4.1. Daily delivered messages

A message containing all the quarter hour power values for the current month is delivered by 8h each day. The day on which the message is sent is the "publication day". The values for and after the "publication day" are set as 0 (quality flag "Inexact"). So, in Figure 1 below, values for all days before Day 2 are published on Day 2.

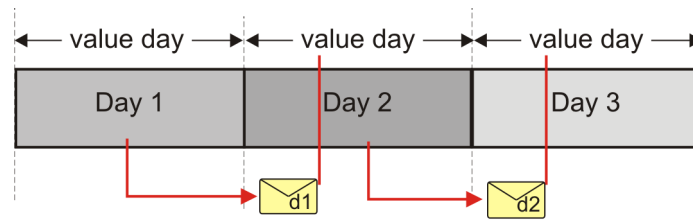

Figure 1 Daily delivery of metering messages

These messages contain non-validated data. The deliveries are listed in section "1.1.8 Regulated messages & message delivery frequency".

1.1.4.2. Monthly validated delivered messages

The delivery of monthly validated messages is illustrated in Figure 2 below.

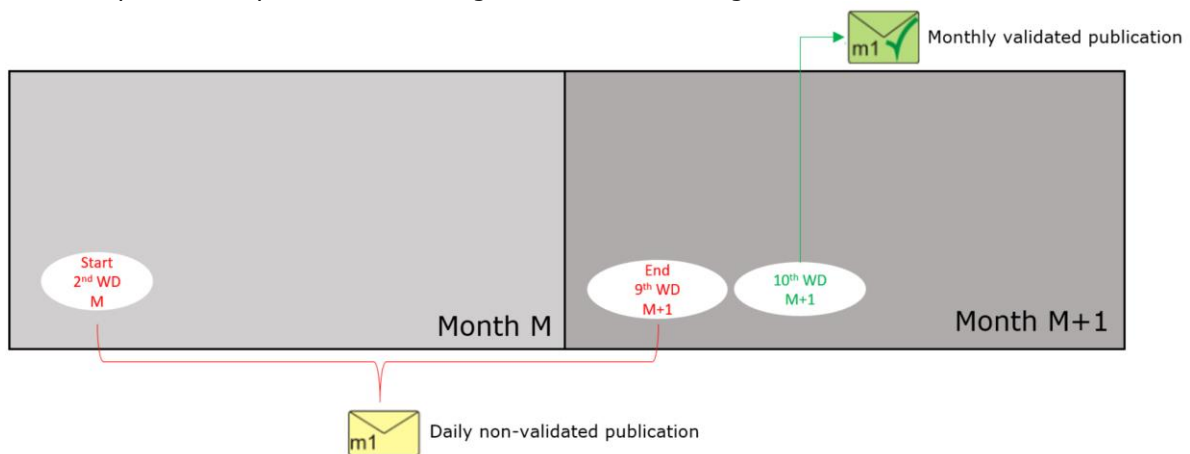

Figure 2 Regular deliveries of monthly messages

When the data is flagged as "validated by Elia", it is no longer updated. In rare cases where corrections need to take place after that, Elia will publish an updated message on the designated publication channel (eVMS/EPIC)".

1.1.5. Accessing messages – protocols

Messages can be delivered using EPIC, the SFTP protocol or an “EVMSB2C” webpage. Section 4.1 explains these protocols and provides a reference section for the development of applications to receive metering data messages.

1.1.6. Accessing messages – formats

Messages are delivered in CSV, XML or Excel (XLSX) formats. The format in which the messages are delivered is defined in the client contract and can be switched if required.

Understanding the contents of messages and the full details on the structure of CSV, XML and XLSX message formats are explained and given in Chapter 2 on “Understanding messages”.

1.1.7. Message formats and protocols independency

The format of messages and the protocols are independent. Technically, it is therefore possible to receive any format type using any protocol.

More information about the messages formats in Chapter 2 and protocols in Chapter 4.

1.1.8. Regulated messages & message delivery frequency

Table 1 lists all the stakeholders roles, the corresponding regulated messages they can receive and their delivery frequency.

Explanation of abbreviations used in the table 1 :

- CD = Calendar Day
- WD = Work Day
- 4thWD-1 = The calendar day before the 4th Work Day
- 10thWD-1 = The calendar day before the 10th Work Day
- Previous month: metering of the previous month sent the current month

Role	Message Type	Message publication frequency		
		Non-validated (Intermediate)	Validated (Final)	Format
GU	Access Point	Previous month is published from 1 st to 9 th CD Current month is published every day	Previous month is published on the 10 th CD	CSV, XML and XLSX
	CDS Access Point	Previous month is published from 1 st to 9 th CD Current month is published every day	N/A	
	SubAccess Delivery Point	Previous month is published from 1 st to 9 th CD Current month is published every day	Previous month is published on the 10 th CD	
	Metering Point	Previous month is published from 1 st to 9 th CD Current month is published every day	Previous month is published on the 10 th CD	
	Offshore Interconnection Point	Previous month is published from 1 st to 9 th CD Current month is published every day	Previous month is published on the 10 th CD	XML and XLSX
ACH	Access Point	Previous month is published from 1 st to 9 th CD Current month is published every day	Previous month is published on the 10 th CD	CSV, XML and XLSX
BRP	Access Point	Previous month is published from 1 st to 9 th CD Current month is published every day	Previous month is published on the 10 th CD	
	GEMP	Previous month is published from 1 st to 9 th CD Current month is published every day	Previous month is published on the 10 th CD	
	CDS Access Point	Previous month is published from 1 st to 10 th WD-1 Current month is published every day	Previous month is published on the 10 th WD	
	Imbalance	N/A	Together with invoicing	
	RT DGO Allocation	Previous month is published the 4 first quarter-hours (till 1 AM) of the 1 st CD Current month is published every quarter-hour	N/A	

Role	Message Type	Message publication frequency		
		Non-validated (Intermediate)	Validated (Final)	Format
	SubAccess Delivery Point ¹	Previous month is published from 1 st to 9 th CD Current month is published every day	Previous month is published on the 10 th WD	CSV, XML and XLSX
	Offshore Interconnection Point	Previous month is published from 1 st to 9 th CD Current month is published every day	Previous month is published on the 10 th CD	XML and XLSX
SUP	Access Point	Previous month is published from 1 st to 9 th CD Current month is published every day	Previous month is published on the 10 th CD	CSV, XML and XLSX
	CDS Access Point	Previous month is published from 1 st to 10 th WD-1 Current month is published every day	Previous month is published on the 10 th WD	
	SubAccess Delivery Point ¹	Previous month is published from 1 st to 9 th CD Current month is published every day	Previous month is published on the 10 th WD	
PROD	Access Point	N/A	Previous month is published on the 10 th CD	CSV, XML and XLSX
	Metering Point	N/A	Previous month is published on the 10 th CD	CSV, XML and XLSX
BSP /FSP	Access Point	Previous month is published from 1 st to 9 th CD Current month is published every day	Previous month is published on the 10 th CD	CSV, XML and XLSX
	SubAccess Delivery Point	Previous month is published from 1 st to 10 th WD Current month is published every day	N/A	XML and XLSX
	CDS Access Point	Previous month is published from 1 st to 9 th CD Current month is published every day	Previous month is published on the 10 th CD	CSV, XML and XLSX
	Transfer of Energy (ToE) Delivered volumes (mFRR DP _{PG} & DA/ID)	On event : Previous month is published on 15 th WD	Together with Imbalance invoicing	

¹ Only applicable in case a specific BRP/Supplier is defined at Sub Access Delivery Point level.

Role	Message Type	Message publication frequency		
		Non-validated (Intermediate)	Validated (Final)	Format
MCH	(Non-regulated) Metering Point	Depends on the Client's needs		CSV, XML and XLSX

Table 1 Message delivery frequency

1.2. Related documents

More info about metering services is available from the Elia website:

- General metering page:

<https://www.elia.be/en/customers/metering>

- Technical information, documentations, links... :

<https://www.elia.be/en/customers/customer-tools-and-extranet/metering>

For any other information please contact your Elia Key Account Manager or Metering services (email: Metering.Services@elia.be)

Chapter 2 Understanding messages

This chapter describes the structure of metering message types. It describes how the parameters and type of metered data introduced in the Metering Manual Concepts are incorporated into the messages and is targeted principally at operational staff.

Note: All the stakeholders roles, the corresponding messages types they can receive and delivery frequency of the messages is summarized at section "1.1.8 Regulated messages & message delivery frequency".

2.1. Access Point

An Access Point (AP) corresponds to an Injection and/or Offtake Point to the Elia Grid. Every Access Point is associated with one or more meter(s).

Clients receive messages containing the aggregated metering data values for each Access Point specified in their contracts with Elia.

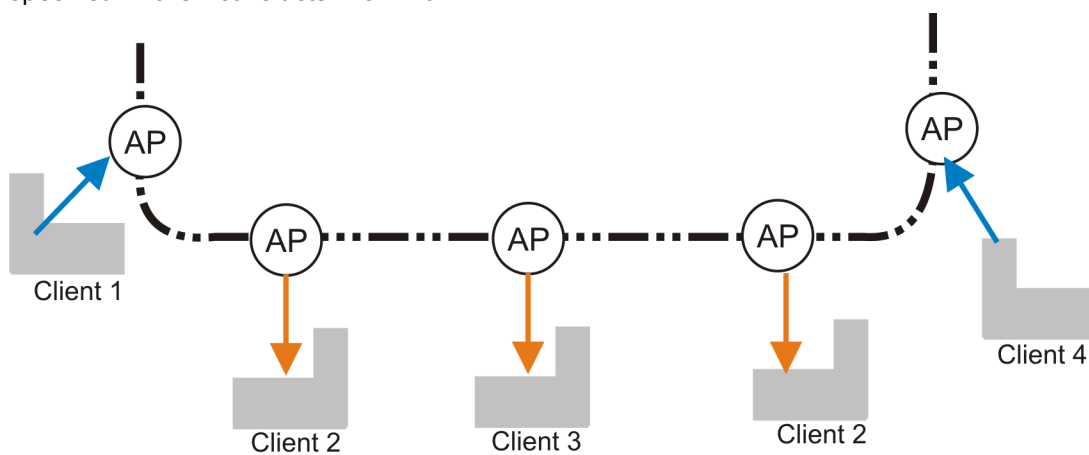

Figure 3 Access Points

Access Point messages are received by clients who can be producers or consumers of energy, or both. The direction of the energy flow is indicated in the message and the values are always positive. These messages identify the client, the Access Point, and all the parameters describing the power transferred as well as the actual power values.

All parameters used to describe power values are explained in the Metering Manual Concepts.

Access Point messages identify the client, the Access Point, the time period, all the parameters used to describe the power values and the actual power values. This message content can be delivered in one of three formats: CSV described in section 2.1.1 below, XML format described in section 2.1.2 and Excel (XLSX) format described in section 2.1.3.

2.1.1.2. [data]

A [data] row contains information about metering values. A [data] section is always followed by at least one [schedule] section. There can be several [data] sections that correspond to different directions. The [data] section identifies the source of the metering data, the direction in which the power flows and the Access Point.

Many [data] rows may be used for different schedules.

[data] ;10X1001A1001A094 ;CONS ;541453105585999982

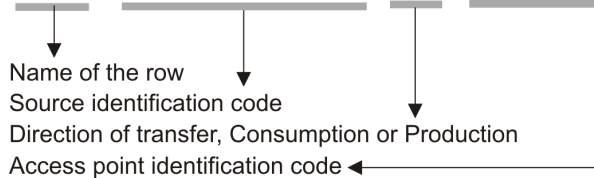

The [data] section is composed of one line. It identifies the source of the metering data, the Access Point at which the data is metered and the energy direction. A message can contain 1 or more [data] sections. Each [data] section can have 1 or more [schedule] sections.

Field	Name	Data type	Comment
1	Name of the row	String	Fixed. Always [data]
2	Source identification code	String	EIC company code of the source of the metering data (Elia)
3	Direction of transfer	String	Identification of the direction of flow (see Metering Manual Concepts). Possible values are: - PROD: Production of active energy (flow from client to Elia) - CONS: Consumption of active energy (flow from Elia to client) - VolumeAdjustment : Corrections for energy transactions performed in the context of Multiple BRPs or Individual Correction (aFRR & mFRR).
4	Access Point identification code	String	EAN (18-digit) code of the Access Point at which the data is metered.

Table 3 CSV Access Point [data] fields

2.1.1.3. [schedule]

A [schedule] section contains the actual power values transferred over the specified time period and identifies the type of power. For any one Access Point (identified in the [data] section) there can be a number of [schedules], those distinguishing the separate transfer of Active and Inductive power for example. The fields contained in the [schedule] are listed below; the general meaning of these fields can be found in The Metering Manual Concepts.

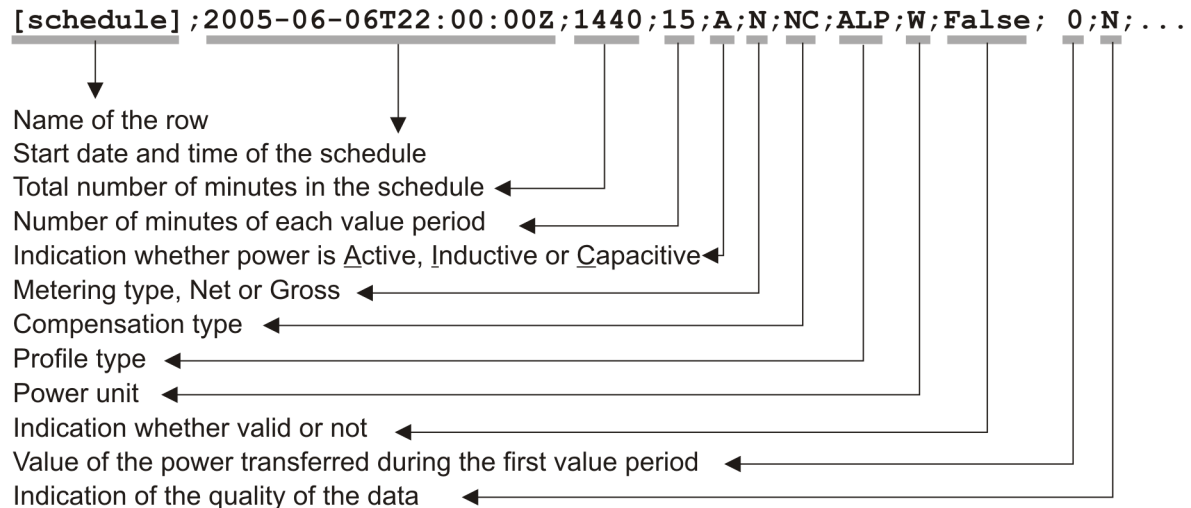

The [schedule] section contains the metering values and their quality. A [schedule] is always related to a parent [data] section. Each [data] section can have 1 or more [schedule] sections. The schedules are normally daily schedules, but any time period is theoretically possible.

Only positive power values are allowed in the Access Point message.

Field	Name	Data type	Comment
1	Name of the row	String	Fixed. Always [schedule]
2	Start date and time	Date	Start date and time of the schedule in ISO 8601 format (see section "3.2 XML elements").
3	Duration	Integer	Total number of minutes in the schedule.
4	Period	Integer	Number of minutes for each value period. Always 15.
5	Power type	String	Identification of the type of power (see Metering Manual Concept). Possible values are: <ul style="list-style-type: none"> • A: Active • I: Inductive • C: Capacitive
6	Metering type	String	Indication as to whether the values are net, gross or specific (see Metering Manual Concept). Possible values are: <ul style="list-style-type: none"> • N: Net • G: Gross

			<ul style="list-style-type: none"> • SP: Corrections for energy transactions performed in the context of Multiple BRPs. • FA: Corrections for energy transactions performed in the context of Individual Correction for aFRR. • FM : Corrections for energy transactions performed in the context of Individual Correction for mFRR.
7	Compensation type	String	<p>Indication as to whether the values compensated or not (see Metering Manual Concept).</p> <p>Possible values are:</p> <ul style="list-style-type: none"> • NC: Non-Compensated. Used for metering purposes. • C: Compensated. Used for billing purposes • A: Reserved for future use • CC: Compensated Corrected used for billing purposes only if corrections for energy transactions performed in the context of Multiple BRPs or Individual Correction (aFRR & mFRR) exist.
8	Profile type	String	<p>Indication of the load profile. This field is reserved for potential future use and has no significant meaning. Possible values are:</p> <ul style="list-style-type: none"> • ALP: Aggregated Load Profile • ULP: Undefined load profile
9	Power unit	String	<p>Unit in which the power values are defined. Possible values are:</p> <ul style="list-style-type: none"> • KWT, KVR, • W, KW, MW, • VAR, KVAR, MVAR
10	Validation	Boolean	<p>Indication as to whether the values are valid or not (see Metering Manual Concept).</p> <p>Possible values are:</p> <ul style="list-style-type: none"> • True: validated by Elia • False: not validated by Elia
11 to 203 in	Value	Unsigned Decimal	Value of the transferred power. The value is always positive. The value is expressed in the defined unit and

steps of 2			contains a maximum of 3 digits after the decimal point.
12 to 204 in steps of 2	Quality	1 char	Indication as to the quality of the metered data (see Metering Manual Concept). Possible values are: <ul style="list-style-type: none">• N: Normal• I: Inexact• S: Substituted (Estimated replacement).

Table 4 CSV Access Point [schedule] fields

2.1.2. XML Access Point

Access Point metering data is delivered in an XML file with the root element `<AccessPointValues>`. The `<AccessPointValues>` file consists of a `<header>` element, which refers to the message and a `<data-list>` element which contains the power transfer data.

```
<?xml version="1.0" encoding="iso-8859-1"?>
<AccessPointValues xmlns="http://www.elia.be/namespaces/public/evms/b2bmsg">
+ <header>
+ <data-list >
</AccessPointValues>
```

Example 2 XML Access Point message root

2.1.2.1. <header>

The `<header>` element is mandatory. The single `<header>` element contains information about the sender of the message (Elia) and the receiver as well as the time when the message was created.

```
<header>
+ <sender> (contains fields identifying the sender)
+ <receiver> (contains fields identifying the receiver)
  <timestamp>2004-02-05T09:31:10Z</timestamp>
</header>
```

Example 3 XML Access Point message <header>

The contents of the `<header>` element are listed in the table below.

Element name	Element content	Content type	Cardinality	Description
<code><sender></code>	elements	<code><party></code> elements, (see section 3.2.1)	mandatory	Identification of message sender
<code><receiver></code>	elements		mandatory	Identification of message receiver
<code><timestamp></code>	text	date	mandatory	Creation time of the message

Table 5 XML <header> element for Access Point messages

2.1.2.2. <data-list>

The `<data-list>` can contain one or more `<data>` element.

```
<data-list>
+ <data>
</data-list>
```

Example 4 XML Access Point message <data-list>

The `<data>` element describes the flow of the power (from and to the parties concerned), the schedule of actual power values and the Access Point. The direction of the transfer of power is indicated by the optional `<partyFrom>` and `<partyTo>` elements.

```
<data>
+ <partyFrom> (fields defining the flow of energy)
+ <partyTo>
  <schedule-list>
+ <schedule> (describes the power and the values)
  </schedule-list>
+ <point> (contains fields identifying the Access Point)
</data>
```

Example 5 XML Access Point message <data>

The general meaning of these fields is given in The Metering Manual Concept. The contents of each <data> element are listed in the table below.

Element name	Element content	Content type	Cardinality	Description
<partyFrom>	elements	<party> elements, (see section 3.2.1).	optional	Fields identifying the party FROM which the power is flowing.
<partyTo>	elements		optional	Field identifying the party TO which the power is flowing
<schedule-list>	elements	<schedule> elements (see section 0).	mandatory	Fields identifying the characteristics of the transferred power and the values.
<point>	elements	<point> elements (see section 0).	mandatory	Fields identifying the Access Point

Table 6 XML <data> element for Access Point messages



2.1.3. Excel (XLSX) Access Point

The Excel file contains one sheet named from the Access Point EAN code: this sheet contains all information about the Access Point at the given month.

An example of Excel format Access Point message is shown below. This example contains four metering columns each referring to diverse types of metering at one Access Point. The top rows contain information about the receiver, the Access Point code and name and the time of creation (last update) of the message.

Subsequent area of the sheet is divided into columns:

- The first lines of the columns give information about the metering data (direction of the flow, power type, metering type, compensation type)
- The quarter hourly values give the power value and the quality for the mentioned metering data

	A	B	C	D	E	F	G	H	I	J	K	
1	Company	22XXXXXXXXXXXXC		Test company								
2	Meterable	541453167414516216		Access Point test								
3	Last Update	23-04-2014										
4	Validation Status	Non validated by Elia										
5												
6		Meterable type		Outgoing Active Gross		Outgoing Active Net		Incoming Active Gross		Incoming Active Net		
7				Compensated	Quality	Compensated	Quality	Compensated	Quality	Compensated	Quality	
8				0 KWh	Invalid	0 KWh	Invalid	0 KWh	Invalid	0 KWh	Invalid	
9		Monthly energy										
10												
11		Quarter hourly values										
12		Date	From	To	W	W	W	W	W	W	W	
13		01-01-2015	00:00	00:15	0	I	0	I	0	I	0	I
14		01-01-2015	00:15	00:30	0	I	0	I	0	I	0	I
15		01-01-2015	00:30	00:45	0	I	0	I	0	I	0	I
16		01-01-2015	00:45	01:00	0	I	0	I	0	I	0	I
17		01-01-2015	01:00	01:15	0	I	0	I	0	I	0	I
18		01-01-2015	01:15	01:30	0	I	0	I	0	I	0	I
19		01-01-2015	01:30	01:45	0	I	0	I	0	I	0	I
20		01-01-2015	01:45	02:00	0	I	0	I	0	I	0	I
21		01-01-2015	02:00	02:15	0	I	0	I	0	I	0	I
22		01-01-2015	02:15	02:30	0	I	0	I	0	I	0	I
23		01-01-2015	02:30	02:45	0	I	0	I	0	I	0	I
24		01-01-2015	02:45	03:00	0	I	0	I	0	I	0	I
25		01-01-2015	03:00	03:15	0	I	0	I	0	I	0	I
26		01-01-2015	03:15	03:30	0	I	0	I	0	I	0	I
27		01-01-2015	03:30	03:45	0	I	0	I	0	I	0	I
28		01-01-2015	03:45		0	I	0	I	0	I	0	I

Figure 4 Sheet in a CSV Access Point message

The Access Point Excel sheet consists of the following sections:

- A header section.
- A set of columns headers.
- A set of columns values.

2.1.3.1. Header

The header contains reference of the Access Point and the receiver.

	A	B	C	D
1	Company	22XXXXXXXXXXXXC		Test company
2	Meterable	541453167414516216		Access Point test
3	Last Update	23-04-2014		
4	Validation Status	Non validated by Elia		

Figure 5 Access Point message header

Excel Cell	Name	Data type	Comment
B1:C1 (merged cells)	Receiver identification code	String	EIC company code of the receiver of the message.
D1:F1 (merged cells)	Receiver name	String	Name of the company receiver of the message. Note this is a "display name" that can be different from the official name of the company
B2:C2 (merged cells)	Access Point identification code	String	EAN (18-digit) code of the Access Point at which the data is metered.
D2:F2 (merged cells)	Access Point name	String	Name of the Access Point at which the data is metered
B3:C3 (merged cells)	Last update date	Date and time	Date and time of the creation of the highest version of this document.
B4:C4 (merged cells)	Validation	String	Indication as to whether the values are valid or not (see Metering Manual Concepts). Possible values : <ul style="list-style-type: none"> • "validated by Elia" • "Non-validated by Elia"

Table 7 Excel Access Point header fields

2.1.3.2. Columns header

From the 4th column, 2 columns identify the source of each metering data metered at the Access Point. An Excel sheet can contain 1 or more set of columns.

For one column (example Column 4):

	A	B	C	D
6	Meterable type			Outgoing
7				Active
8				Gross
9				Compensated

Figure 6 CSV Access Point message – columns header

The content of the header is listed in the table below:

Line	Name	Data type	Comment
6	Direction of transfer	String	<p>Identification of the direction of flow (see Metering Manual Concepts). Possible values are:</p> <p>“Incoming”: Production of active energy (flow from client to Elia)</p> <p>“Outgoing”: Consumption of active energy (flow from Elia to client)</p> <p>“VolumeAdjustment”: Corrections for energy transactions performed in the context of Multiple BRPs or Individual Correction (aFRR & mFRR).</p>
7	Power type	String	<p>Identification of the type of power (see Metering Manual Concepts). Possible values are:</p> <ul style="list-style-type: none"> • Active • Inductive • Capacitive
8	Metering type	String	<p>Indication as to whether the values are net or gross or specific (see Metering Manual Concepts). Possible values are:</p> <ul style="list-style-type: none"> • Net • Gross • SupplySplit : Corrections for energy transactions performed in the context of Multiple BRPs. • FlexibilityaFRR: Corrections for energy transactions performed in the context of Individual Correction for aFRR. • FlexibilitymFRR :Corrections for energy transactions performed in the context of Individual Correction for mFRR.

9	Compensation type	String	<p>Indication as to whether the values compensated or not (see Metering Manual Concepts). Possible values are:</p> <ul style="list-style-type: none"> • NC: Non-Compensated. Used for metering purposes. • C: Compensated. Used for billing purposes • A: Reserved for future use • CC: Compensated Corrected used for billing purposes only if corrections for energy transactions performed in the context of Multiple BRPs or Individual Correction (aFRR & mFRR) exist.
10	Sum of the monthly energy		Excel formula = the sum of all quarter hourly values and related unit
13	Power unit	String	<p>Unit in which the power values are defined. Possible values are:</p> <ul style="list-style-type: none"> • KWT, KVR, • W, KW, MW, • VAR, KVAR, MVAR

Table 8 Excel Access Point column metering reference

2.1.3.3. Columns values

The same columns (starting from the 4th column), contain the metering values and their quality (on the next column) All the quarter hourly values of the month are present. Only positive power values are allowed in the Access Point message.

Column	Name	Data type	Comment
4, 6, 8, 10, 12, etc.	Value	Unsigned Decimal	Value of the transferred power for the given quarter. The value is always positive. The value is expressed in the defined unit and contains a maximum of 3 digits after the decimal point. If there is no decimal, then no decimal point
5, 7, 9, 11, 13, etc.	Quality	1 char	Indication as to the quality of the metered data for the given quarter (see Metering Manual Concepts). Possible values are: <ul style="list-style-type: none"> • N: Normal • I: Inexact • S: Substituted (Estimated replacement).

Table 9 Excel Access Point columns cells

Remark: The decimal point, in Excel, being subject to the settings, it can be different from the figure shown in this document

2.2. SubAccess Delivery Point

The SubAccess Delivery Point (SP), also known as Submetering Delivery Point refers to a point:

- within the electrical facilities of a grid user downstream of an Access Point connected to the Elia Grid
- or within a CDS connected to the Elia Grid

from which a flexibility service can be delivered to Elia or for which a BRP and SUP have been defined (Multiple BRPs). Every SubAccess Delivery Point is associated with one or more meter(s).

The metering data is published to the flexibility supplier via the generic role of the Balance Service provider (BSP) /Flexibility Service Provider (FSP) if the SubAccess Delivery Point delivers flexibility services.

The flexibility service can be:

- Strategic Demand Reserve (SDR)
- mFRR
- DA/ID service
- Any future service

The data is published to the BRP and the Supplier if a specific BRP and Supplier have been defined for this SubAccess Delivery Point (Multiple BRPs).

All of the parameters used to describe power values are explained in The Metering Manual Concept.

2.2.1. Message content and structure

The SubAccess Delivery Point message contains the same information as the Metering Point message described in Section 2.3.

Only the name of the file contains "SP" and not "MP".

2.3. Metering Point

A Metering Point (MP) is a generic message that can be used for two different purposes:

1. The putting at disposal of the metering data coming from one meter (without any aggregation). For example, a local production unit or a connection point.

These Metering Points are provided by Elia at no extra cost to the Grid User and is part of the "standard metering".

2. The putting at disposal of additional data requested by a Grid User and specified in a commercial contract between the client and Elia (non-regulated metering).
 - Such data might include:
 - The (physical) energy flow at a given point, like a local production
 - Non-electric values at a virtual point, such as temperature, imbalance, prices, etc.
 - A Metering Point message's content will depend on the client's specific requirements. Since they can contain measured quantities other than power, the corresponding unit is provided in the message too. Examples of non-electric units are:
 - Euro per MW (E/MW)
 - Hertz (HRTZ)
 - Cubic Meter per hour (M3/H)
 - GigaJoules per hour (GJ/H)
 - Celsius (°C)

For compatibility reasons, these units are placed in the same fields as the power units.

- Such data are always published into a specific role: MCH (Metering Contract Holder): more information can be obtained from your Key Account Manager or on the Elia website <https://www.elia.be/en/customers/metering/additional-metering-services>

When non-regulated, the content of Metering Point messages will depend on the client's specifications as set out in the contract. The general structure of the messages follows that of the regulated messages and is set out here.

2.3.1. CSV Metering Point message

The Metering Point message contains a single [header] section, followed by a series of [data] sections, each of which contains a [schedule]. An example of CSV format Metering Point message containing a non-electric [schedule] with negative values (imbalance schedule) is shown below. Because this message contains non-electric data, not all the fields used to describe electric power values are relevant and so there are some that are left blank.

```
[header];10X1001A1001A094;22XXXXXXXXXXXX--Z;2007-02-15T07:59:33+01:00
[data];10X1001A1001A094;CONS;541453114157831663
[schedule];2006-12-31T23:00:00Z;1440;15;A;;;ALP;KW;False; 133.6;N; 85.2;N; 95.6;N; 211.2;N;-
621.6;N; 164.8;N;-1231.6;N; 150;N; 148.4;N; 203.6;N; 31.2;N; 278;N; 176.8;N; 292.4;N; 344.4;N;
63.6;N; 206;N; 191.2;N; 176;N; 143.6;N; 174.4;N; 123.6;N; 212;N; 24;N;-52;N; 24.8;N; 47.6;N;
32;N; 203.6;N; 13.2;N;-0.8;N;-58.8;N; 402.8;N; 132;N; 131.2;N;-25.2;N;-120.4;N;-8;N;-157.2;N;-
226.8;N;-97.6;N;-148;N;-200;N;-105.6;N;-72.8;N; 27.6;N;-128;N;-253.2;N;-518;N;-20.4;N;
42.8;N;-37.2;N; 163.6;N;-9.2;N; 342.8;N; 8;N; 2.8;N; 143.6;N; 71.2;N; 250.8;N;-81.6;N; 40;N;
152.4;N;-72.8;N; 7.2;N;-63.2;N;-132;N;-362.4;N;-615.6;N;-430.8;N;-49.6;N;-96;N; 141.6;N;
51.6;N; 103.2;N; 63.6;N; 144.4;N;-38;N; 17.6;N; 130;N; 172;N; 107.2;N;-24.8;N; 182.8;N;
37.2;N; 148.8;N; 22;N; 147.6;N;-637.2;N; 42.4;N; 852;N; 62.4;N;-281.2;N; 334.4;N; 324.8;N;
223.2;N
[schedule];2007-01-01T23:00:00Z;1440;15;A;;;ALP;KW;False; 231.2;N; 162.4;N;-1094;N; 182.8;N;-
338;N; 281.6;N; 123.2;N; 283.2;N;-411.6;N; 281.6;N; 364;N; 207.6;N; 217.6;N; 101.2;N; 166.4;N;
39.6;N; 117.6;N; 110.8;N;-29.6;N; 16.8;N;-100.4;N; 52;N;-84.8;N;-54.8;N;-536;N;-1352.8;N;-
352.4;N;-600.8;N;-30.8;N;-396;N;-372;N;-44.4;N; 197.6;N;-459.6;N; 239.2;N;-315.6;N; 99.2;N;-
493.6;N;-350.4;N;-165.6;N;-142.4;N; 70.4;N;-98.8;N; 2;N;-247.6;N;-172;N;-139.2;N;-131.6;N;-
334.4;N; 57.6;N; 203.2;N;-3.6;N; 194.4;N;-20;N; 572.8;N; 341.2;N; 176.8;N;-382;N;-240.4;N;-
62.8;N; 261.2;N;-46.4;N; 74.8;N;-267.6;N;-60.4;N;-79.6;N;-182.4;N;-350;N;-280.4;N;-290.8;N;-
426.4;N;-31.6;N;-116;N; 188.8;N; 273.6;N; 170.4;N; 17.6;N; 278.4;N;-187.2;N; 219.2;N; 630.4;N;
80;N;-483.2;N; 204.8;N; 375.2;N; 279.6;N; 352.8;N; 340;N;-542.8;N; 299.2;N; 538;N; 315.6;N;
32;N; 204.8;N; 144;N; 470.8;N
[end]
```

Example 6 CSV Metering Point message

The Metering Point Message consists of the following sections:

- [header]
- [data]
- [schedule]
- [end] – which is the last line indicating the end of the message. All characters following [end] must be ignored.

2.3.1.1. [header]

The [header] of the message defines the sender and receiver of the message as well as the time of its creation. There is only one [header] row in the message.

```
[header];10X1001A1001A094;22XXXXXXXXXXXX--Z;2007-02-15T07:59:33+01:00
```

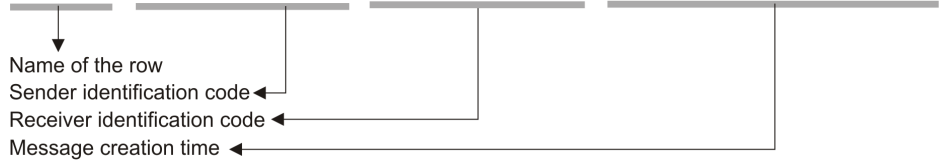

Field	Name	Data type	Comment
1	Name of the row	String	Fixed. Always [header]
2	Sender identification code	String	EIC code (Energy Identification Code) of the TSO (Elia)
3	Receiver identification code	String	EIC code (Energy Identification Code) of the receiver of the message
4	Message creation time	Date	Date and time of the file creation in Iso format
5	Message type	String (optional)	This optional field is reserved for future use but may contain the type of message.
6	Version	String (optional)	This optional field is reserved for future use but may contain the version of the message.

Table 10 CSV Metering Point [header] fields

2.3.1.2. [data]

Each [data] section identifies the source of the metering data, the direction of the power flow and the access (metering) point to which the data relates. A message can contain 1 or more [data] sections.

```
[data];10X1001A1001A094;CONS;541453114157831663
```

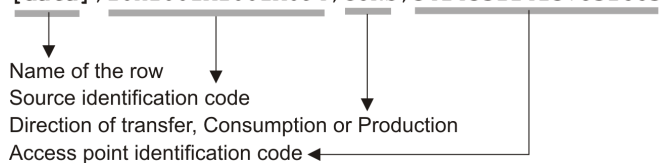

Field	Name	Data type	Comment
1	Name of the row	String	Fixed. Always [data]
2	Source identification code	String	EIC company code of the source of the metering data (Elia)
3	Direction of transfer	String	Identification of the direction of flow (see Metering Manual Concepts). Possible values are: <ul style="list-style-type: none"> PROD: Production of active energy (flow from client to Elia) CONS: consumption of active energy (flow from client to Elia)



			<ul style="list-style-type: none"> VolumeAdjustment : Corrections for energy transactions performed in the context of Multiple BRPs or Individual Correction (aFRR & mFRR).
4	Metering Point identification code	String	EAN (18-digit) code of the Metering Point at which the data is metered.

Table 11 CSV Metering Point message [data] fields

2.3.1.3. [schedule]

The [schedule] section contains the metering values and their status. A [schedule] is always related to a parent [data] section. Each [data] section can have 1 or more [schedule] sections. The schedules are normally daily schedules, but any time period is theoretically possible.

The [schedule] section contains the metered values for the corresponding [data] section. Each [schedule] section identifies all the parameters used to describe the metered quantity as well as the actual metered values. Since Metering Point messages do not necessarily contain power values, some of the fields will be blank.

`[schedule];2006-12-31T23:00:00Z;1440;15;A;;;ALP;KW;False;133.6;N;...`

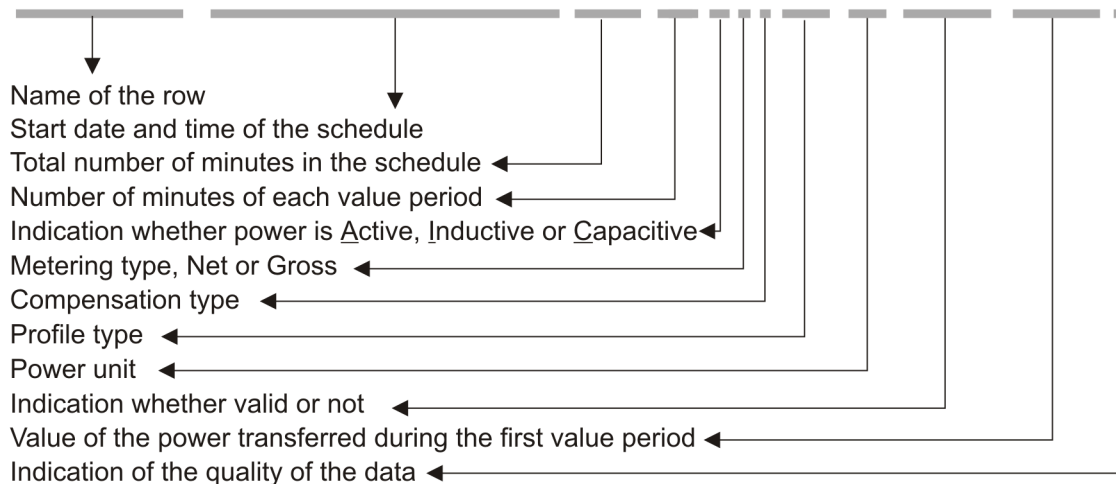

Field	Name	Data type	Comment
1	Name of the row	String	Fixed. Always [schedule]
2	Start date and time	Date	Start date and time of the schedule in ISO 8601 format
3	Duration	Integer	Total number of minutes in the schedule.
4	Period	Integer	Number of minutes for each value period. Always 15.
5	Power type	String (optional)	Identification of the type of power* (see Metering Manual Concepts). Possible values are: <ul style="list-style-type: none"> A: Active I: Inductive C: Capacitive * this has no meaning for non-power values

6	Metering type	String (optional)	<p>Indication as to whether the values are net or gross* or specific (see Metering Manual Concepts). Possible values are</p> <ul style="list-style-type: none"> • N: Net • G: Gross • GG: "Green Gross" • SP: Corrections for energy transactions performed in the context of Multiple BRPs. • FA: Corrections for energy transactions performed in the context of Individual Correction for aFRR. • FM : Corrections for energy transactions performed in the context of Individual Correction for mFRR. <p>* this has no meaning for non-power values</p>
7	Compensation type	String (optional)	<p>Indication as to whether the values are compensated or not* (see Metering Manual Concepts). Possible values are:</p> <ul style="list-style-type: none"> • NC: Non-Compensated. Used for metering purposes. • C: Compensated. Used for billing purposes • A: Reserved for future use • CC: Compensated Corrected used for billing purposes only if corrections for energy transactions performed in the context of Multiple BRPs or Individual Correction (aFRR & mFRR) exist. <p>* this has no meaning for non-power values</p>
8	Profile type	String	<p>Indication of the load profile*. This field is reserved for probable future use and has no significant meaning. Currently, values could be:</p> <ul style="list-style-type: none"> • ALP: Aggregated load profile • ULP: Undefined load profile <p>* this has no meaning for non-power values</p>
9	Unit	String (optional)	<p>Unit in which the metered values are defined. This depends on the quantity being measured.</p>
10	Validation	Boolean	<p>Indication as to whether the values are valid or not. Possible values are:</p> <ul style="list-style-type: none"> • True: validated by Elia • False: not validated by Elia
11 to 203 in steps of 2	Value	signed Decimal	<p>Value of the metered quantity in the unit defined in Field 9 above with a maximum of 3 digits after the decimal point.</p> <ul style="list-style-type: none"> • If the value is negative then the "-" operator is added before the value

			<ul style="list-style-type: none">• If the value is positive then no operator is added
12 to 204 in steps of 2	Quality	1 char	Indication as to the quality of the metered data (see Metering Manual Concepts). Possible values are: <ul style="list-style-type: none">• N: Normal• I: Inexact• S: Substituted (Estimated replacement).

Table 12 CSV Metering Point message [schedule] fields

2.3.2. XML Metering Point message

Metering Point metering data is delivered in an XML file with the root element <MeteringPointValues>

```
<?xml version="1.0" encoding="iso-8859-1"?>
<MeteringPointValues xmlns="http://www.elia.be/namespaces/public/evms/b2bmsg">
+ <header>
+ <data-list >
</MeteringPointValues >
```

Example 7 XML Metering Point message

The message consists of a single <header> element that describes the message and a <data-list> element that contains the specific data.

2.3.2.1. <header>

The <header> element is mandatory. There is one <header> in the message which identifies the sender and receiver and the time it was created.

```
<header>
+ <sender>
+ <receiver>
  <timestamp>2004-02-05T09:31:10Z</timestamp>
</header>
```

The contents of the <header> element are listed in the table below.

Element name	Element content	Content type	Cardinality	Description
<sender>	elements	<party> elements, (see section 3.2.1).	mandatory	Identification of message sender
<receiver>	elements		mandatory	Identification of message receiver
<timestamp>	text	date	mandatory	Time at which the message was created.

Table 13 XML <header> element for Metering Point messages

2.3.2.2. <data-list>

The <data-list> element contains several <data> elements. Each of the <data> elements identify the data values and the Access Point.

```
<data-list>
<data>
+ <partyFrom>
+ <partyTo>
+ <schedule-list>
  <MPEanCode>8714252005707</MPEanCode>
</data>
</data-list>
```

The contents of each <data> element are listed in the table below.

Element name	Element content	Content type	Cardinality	Description
<partyFrom>	elements	<party> elements, see section 3.2.1).	optional	Optional field indicating the direction of flow if the data is power.
<partyTo>	elements		optional	
<schedule-list>	elements	<schedule> elements (see section 0).		Fields identifying the characteristics of the metered data and their values.
<MPEanCode>	text	string	mandatory	Metering Point EAN Code

Table 14 XML <data> element for Metering Point messages

2.3.3. Excel (XLSX) Metering Point message

The Excel file contains one sheet named from the EAN code: This sheet contains all information about the Metering Point for the given month:

The top rows contain information about the receiver, the Metering Point code and name and the time of creation (last update) of the message. Subsequent areas of the sheet is divided into columns.

The first lines of the columns give information about the metering data (direction of the flow, power type, metering type, compensation type). The quarter hourly values give the power value and the quality for the mentioned metering data. Because this message may contain non-electric data, not all the fields used to describe electric power values are relevant and so there are some that may be left blank.

	A	B	C	D	E	F
1	Company					
2	Meterable	541453138157290220				
3	Last Update	23-04-2014				
4	Validation Status	Non validated by Elia				
5						
6	Meterable type			Incoming		
7				Active		
8				Net		
9				Alternative	Quality	
10	Monthly energy			0 KWh	Invalid	
11						
12	Quarter hourly values					
13	Date	From	To	W		
14	01-01-2015	00:00	00:15	0	I	
15	01-01-2015	00:15	00:30	0	I	
16	01-01-2015	00:30	00:45	0	I	
17	01-01-2015	00:45	01:00	0	I	
18	01-01-2015	01:00	01:15	0	I	
19	01-01-2015	01:15	01:30	0	I	
20	01-01-2015	01:30	01:45	0	I	
21	01-01-2015	01:45	02:00	0	I	
22	01-01-2015	02:00	02:15	0	I	
23	01-01-2015	02:15	02:30	0	I	
24	01-01-2015	02:30	02:45	0	I	
25	01-01-2015	02:45	03:00	0	I	
26	01-01-2015	03:00	03:15	0	I	
27	01-01-2015	03:15	03:30	0	I	
28	01-01-2015	03:30	03:45	0	I	

Example 8 Excel (XLSX) Metering Point message

The Metering Point message consists of the following sections:

- A header.
- A set of columns headers.
- A set of columns values.

2.3.3.1. Header

The header contains reference of the Metering data and the receiver. The information is the same as the Access Point described in Section 2.1.3

2.3.3.2. Column headers

Same as the Access Point described in Section 2.1.3

2.3.3.3. Column values

Same as the Access Point described in Section 2.1.3

2.4. CDS Access Point

A 'Closed Distribution System Access Point' or 'CDS Access Point' is the access point to the Closed Distribution System of a Closed Distribution System User, where all its physical Injections and/or Off-takes of Active Power within the Closed Distribution System can be aggregated (virtually if applicable).

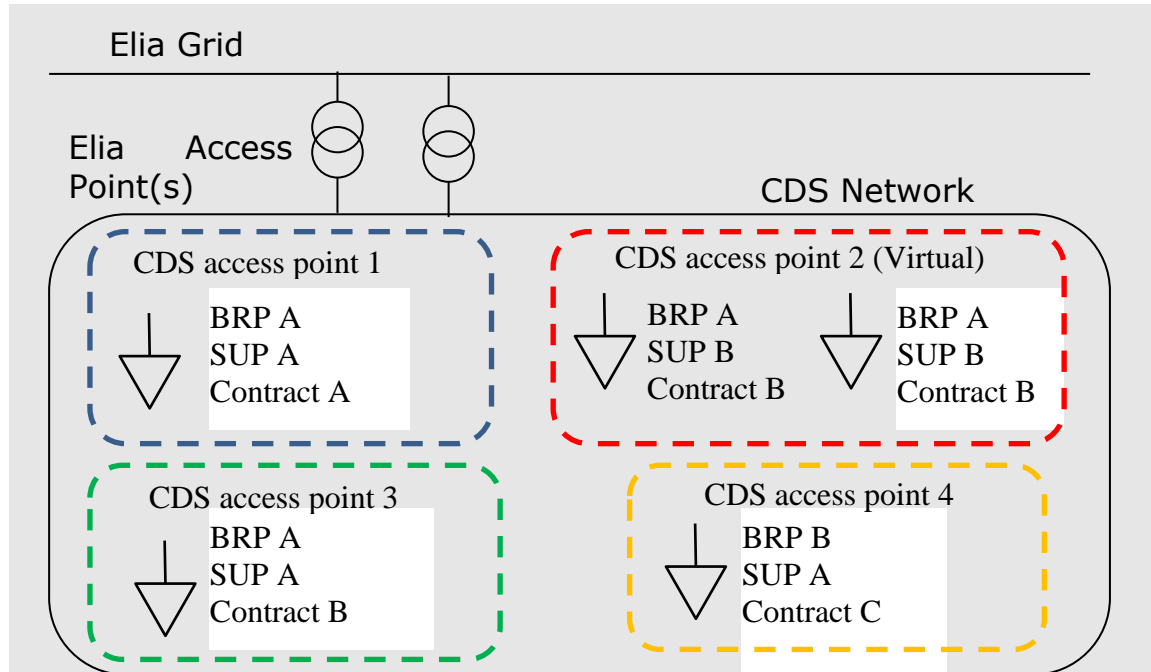

Metering data messages are sent by the CDS Operator to Elia and republished by Elia to the CDS grid user (only in case of real Access Point), BRP, Supplier and BSP according to the contracts of these clients.

CDS Access Point messages identify the client, the CDS Access Point, the time period, all the parameters used to describe the power values and the actual power values. They follow the "Metering Point" format.

All of the parameters used to describe power values are explained in The Metering Manual Concept. Full details on all the descriptive fields and the possible values they can take can be found in:

- section 2.4.1 (for the CSV format messages)
- section 2.4.2 (for the XML format messages)
- section 2.4.3 (for the XLSX format messages)



2.4.1. CSV CDS Access Point message

CDS Access Point messages contain a [header] row, a [data] row and [schedule] sections. An example of a CSV CDS Access Point message is shown below.

```
[header];10X1001A1001A094;22XXXXXXXXXXXX--Z;2007-02-15T07:59:33+01:00
[data];10X1001A1001A094;CONS;541453114157831663
[schedule];2006-12-31T23:00:00Z;1440;15;A;;;ALP;KW;False; 133.6;N; 85.2;N; 95.6;N; 211.2;N;-
621.6;N; 164.8;N;-1231.6;N; 150;N; 148.4;N; 203.6;N; 31.2;N; 278;N; 176.8;N; 292.4;N; 344.4;N;
63.6;N; 206;N; 191.2;N; 176;N; 143.6;N; 174.4;N; 123.6;N; 212;N; 24;N;-52;N; 24.8;N; 47.6;N;
32;N; 203.6;N; 13.2;N;- .8;N;-58.8;N; 402.8;N; 132;N; 131.2;N;-25.2;N;-120.4;N;-8;N;-157.2;N;-
226.8;N;-97.6;N;-148;N;-200;N;-105.6;N;-72.8;N; 27.6;N;-128;N;-253.2;N;-518;N;-20.4;N;
42.8;N;-37.2;N; 163.6;N;-9.2;N; 342.8;N; 8;N; 2.8;N; 143.6;N; 71.2;N; 250.8;N;-81.6;N; 40;N;
152.4;N;-72.8;N; 7.2;N;-63.2;N;-132;N;-362.4;N;-615.6;N;-430.8;N;-49.6;N;-96;N; 141.6;N;
51.6;N; 103.2;N; 63.6;N; 144.4;N;-38;N; 17.6;N; 130;N; 172;N; 107.2;N;-24.8;N; 182.8;N;
37.2;N; 148.8;N; 22;N; 147.6;N;-637.2;N; 42.4;N; 852;N; 62.4;N;-281.2;N; 334.4;N; 324.8;N;
223.2;N
[schedule];2007-01-01T23:00:00Z;1440;15;A;;;ALP;KW;False; 231.2;N; 162.4;N;-1094;N; 182.8;N;-
338;N; 281.6;N; 123.2;N; 283.2;N;-411.6;N; 281.6;N; 364;N; 207.6;N; 217.6;N; 101.2;N; 166.4;N;
39.6;N; 117.6;N; 110.8;N;-29.6;N; 16.8;N;-100.4;N; 52;N;-84.8;N;-54.8;N;-536;N;-1352.8;N;-
352.4;N;-600.8;N;-30.8;N;-396;N;-372;N;-44.4;N; 197.6;N;-459.6;N; 239.2;N;-315.6;N; 99.2;N;-
493.6;N;-350.4;N;-165.6;N;-142.4;N; 70.4;N;-98.8;N; 2;N;-247.6;N;-172;N;-139.2;N;-131.6;N;-
334.4;N; 57.6;N; 203.2;N;-3.6;N; 194.4;N;-20;N; 572.8;N; 341.2;N; 176.8;N;-382;N;-240.4;N;-
62.8;N; 261.2;N;-46.4;N; 74.8;N;-267.6;N;-60.4;N;-79.6;N;-182.4;N;-350;N;-280.4;N;-290.8;N;-
426.4;N;-31.6;N;-116;N; 188.8;N; 273.6;N; 170.4;N; 17.6;N; 278.4;N;-187.2;N; 219.2;N; 630.4;N;
80;N;-483.2;N; 204.8;N; 375.2;N; 279.6;N; 352.8;N; 340;N;-542.8;N; 299.2;N; 538;N; 315.6;N;
32;N; 204.8;N; 144;N; 470.8;N
[end]
```

Example 9 CSV CDS Access Point message

2.4.1.1. [header]

The [header] of the message defines the sender and receiver of the message as well as the time of its creation. There is only one [header] row in the message.

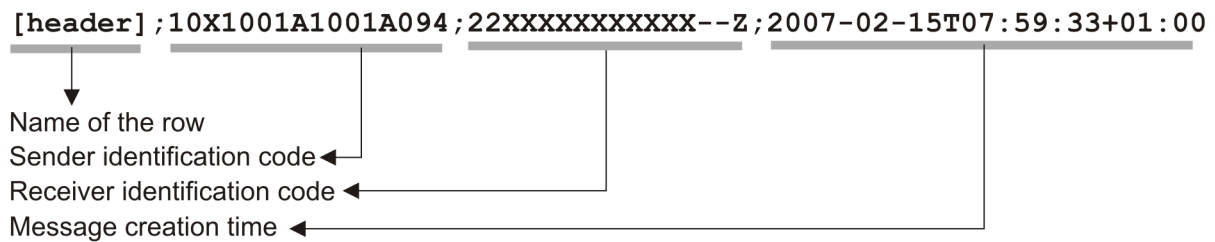

2.4.1.2. [data]

Each [data] section identifies the source of the metering data, the direction of the power flow and the access (metering) point to which the data relates.

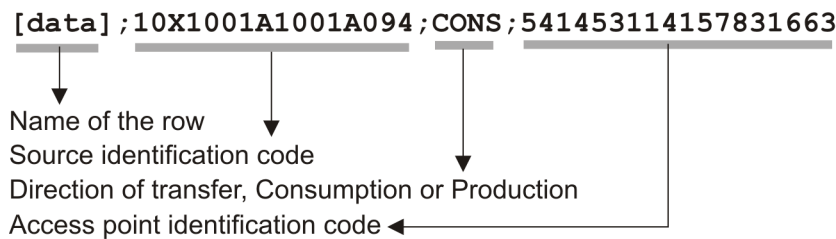



2.4.1.3. [schedule]

The [schedule] section contains the metered values for the corresponding [data] section. Each [schedule] section identifies all the parameters used to describe the metered quantity as well as the actual metered values.

[schedule];2006-12-31T23:00:00Z;1440;15;A;;ALP;KW;False;133.6;N;...

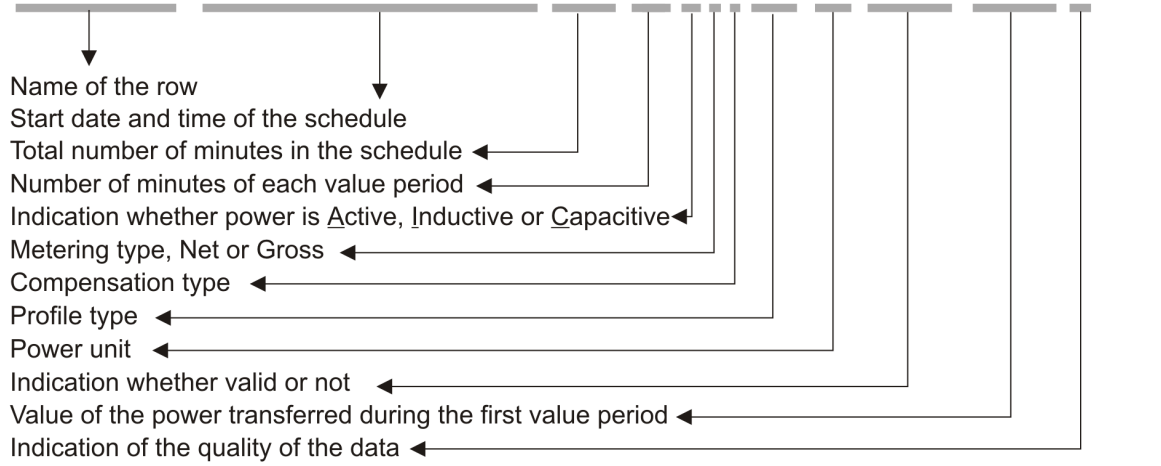

Details on all the values that these fields can take are given in Section 2.3.1 (CDS Access Point messages follow the same structure as Metering Points).

2.4.2. XML CDS Access Point message structure

Closed Distribution System Access Point metering data is delivered in an XML file with the root element <MeteringPointValues>

```
<?xml version="1.0" encoding="iso-8859-1"?>
<MeteringPointValues xmlns="http://www.elia.be/namespaces/public/evms/b2bmsg">
+ <header>
+ <data-list >
</MeteringPointValues >
```

Example 10 XML CDS Access Point message root

The single <header> element contains information about the sender of the message (Elia) and the receiver as well as the time when the message was created.

```
<header>
+ <sender> (contains fields identifying the sender)
+ <receiver> (contains fields identifying the receiver)
  <timestamp>2004-02-05T09:31:10Z</timestamp>
</header>
```

Example 11 XML CDS Access Point message <header>

The <data-list> can contain one or more <data> element.

```
<data-list>
+ <data>
</data-list>
```

Example 12 XML CDS Access Point message <data-list>

The <data > element describes the flow of the power (from and to the parties concerned), the schedule of actual power values and the Access Point.

```
<data>
+ <partyFrom> (fields defining the flow of energy)
+ <partyTo>
  <schedule-list>
  + <schedule> (describes the power and the values)
  </schedule-list>
+ <point> (contains fields identifying the Access Point)
</data>
```

Example 13 XML CDS Access Point message <data>

The general meaning of these fields is given in The Metering Manual Concepts and a full description of all the fields and the values they can take is given in section 2.1.2.

2.4.3. Excel CDS Access Point message structure

The Excel file contains one sheet named from the CDS Access Point EAN code: This sheet contains all information about the CDS Access Point for the given month:

The top rows contain information about the receiver, the CDS Access Point EAN code and name and the time of creation (last update) of the message.

Subsequent areas of the sheet are divided into columns. The first lines of the columns give information about the metering data (direction of the flow, power type, metering type, compensation type)

	A	B	C	D	E	F
1	Company					
2	Meterable	541453138157290220				
3	Last Update	23-04-2014				
4	Validation Status	Non validated by Elia				
5						
6	Meterable type			Incoming		
7				Active		
8				Net		
9				Alternative	Quality	
10	Monthly energy			0 KWh	Invalid	
11						
12	Quarter hourly values					
13	Date	From	To	W		
14	01-01-2015	00:00	00:15	0	I	
15	01-01-2015	00:15	00:30	0	I	
16	01-01-2015	00:30	00:45	0	I	
17	01-01-2015	00:45	01:00	0	I	
18	01-01-2015	01:00	01:15	0	I	
19	01-01-2015	01:15	01:30	0	I	
20	01-01-2015	01:30	01:45	0	I	
21	01-01-2015	01:45	02:00	0	I	
22	01-01-2015	02:00	02:15	0	I	
23	01-01-2015	02:15	02:30	0	I	
24	01-01-2015	02:30	02:45	0	I	
25	01-01-2015	02:45	03:00	0	I	
26	01-01-2015	03:00	03:15	0	I	
27	01-01-2015	03:15	03:30	0	I	
28	01-01-2015	03:30	03:45	0	I	

Example 14 Excel (XLSX) CDS Access Point message

CDS Access Point messages follow the same structure as Metering Points. See Section 2.3.3.

2.5. Offshore Interconnection Point

The Offshore Interconnection Point has the same format as the Access Point.

2.6. GEMP

The Global Elia Metered Position (GEMP) message provides aggregated data to the Balance Responsible Parties (BRP). The data is summed in three ways:

- Nationally over all Belgium.
 - ⇒ *Each of the power values contained is the total sum of the active energy for all Access Points of the BRP.*
- Regionally over each regulated region in Belgium.
 - ⇒ *Each of the power values contained is the sum of the active energy for all Access Points of the BRP in a particular region.*
- Regionally for each region and each Supplier.
 - ⇒ *Each of the power values contained is the sum of the active energy for all Access Points of the BRP in a particular region that are fed by a particular Supplier.*

All the data is delivered in one message, with separate data sections for the different summations. The regions supported are:

- Flanders (FLE)
- Wallonia (WAL)
- Brussels (BRU)
- Federal (FED)

A schematic representation of an arrangement of BRPs, Suppliers and regions to illustrate this is shown in the Figure below:

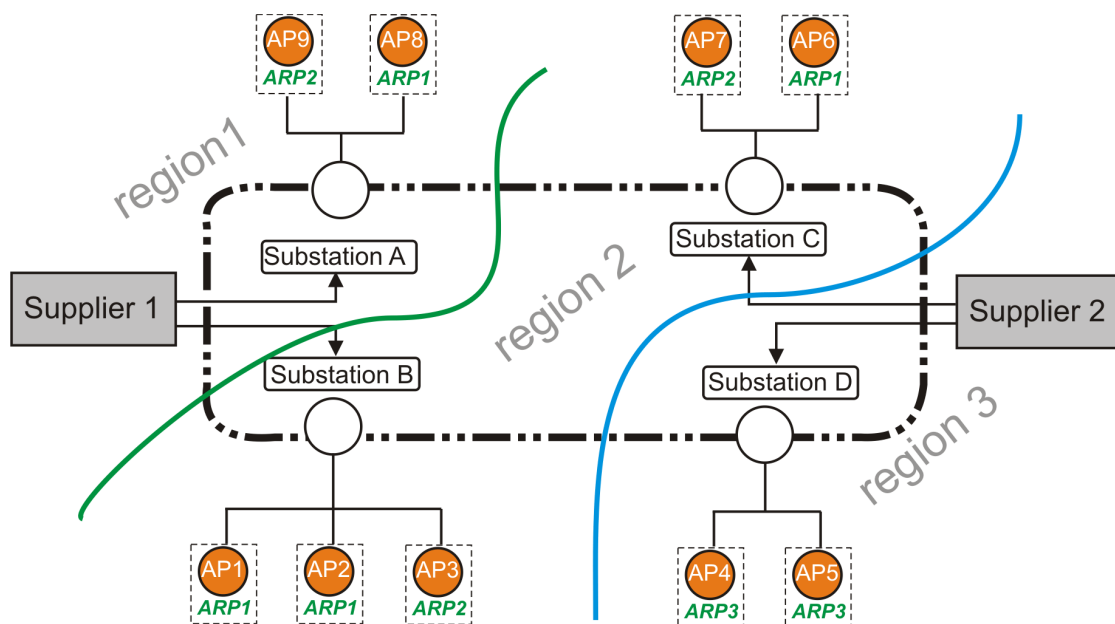

Figure 7 GEMP messages²

² ARP is the former denomination for BRP

Let us consider, for example, the messages received by BRP1 responsible for 4 Access Points (ARP1, ARP2, ARP6 and ARP8). BRP1 will receive Access Point messages for each of these Access Points but will in addition receive the following summed data:

- Summed data nationally – which is the total summation of all the Access Points for which BRP1 is responsible in all regions, (AP1+AP2+AP6+ AP8)
- Summed data/ region for regions 1 (AP8) and 2 (AP1+ AP2+AP6). BRP1 does not operate in region 3.
- Summed data / region / supplier
 - region 1 / supplier 1 (AP8)
 - region 2 / supplier 1 (AP1+AP2)
 - region 2 / supplier 2 (AP6)

Note: a BRP is only working with active data (A).

Summed metered data (GEMPs) are delivered in single messages with separate data sections that contain the different summations, i.e. national summation for all Belgium, summation per regulated region and summation per region and per supplier. This message content can be delivered in one of three formats; CSV described in section 2.6.1, XML format described in section 2.6.2 and Excel format described in section 2.6.3.

2.6.1.1. [header]

The header of the message defines the sender and receiver of the message and its creation time. There is only one [header] row in the message.

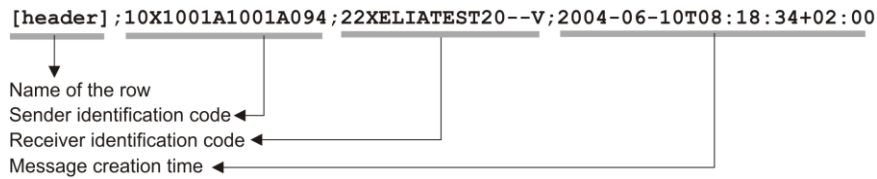

Field	Name	Data type	Comment
1	Name of the row	String	Fixed. Always [header]
2	Sender identification code	String	EIC code (Energy Identification Code) of the sender of the message (Elia).
3	Receiver identification code	String	EIC code of the receiver of the message of the message.
4	Message creation time	Date	Date and time of the file creation in ISO 8601 format
5	Message type	String	Fixed. Always "GEMP ARP"
6	Version	String (optional)	This optional field is reserved for future use but may contain the version of the message.

Table 15 CSV GEMP [header] fields

2.6.1.2. [data(x)]

There are three data sections in the message that correspond to the three summations, [dataG], which refers to the national (global) aggregated data, [dataR] which refers to the data per region and [dataS] which refers to data per region per supplier.

2.6.1.2.1. [dataG]

[dataG] contains the national (global) summation for all Access Points in Belgium that are in the scope of responsibility of the BRP. Each [dataG] section in the message identifies the source of the metering data and the direction of the power flow.

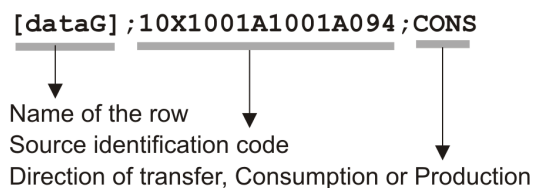

Field	Name	Data type	Comment
1	Name of the row	String	Fixed. Always [dataG]
2	Source identification code	String	EIC code of the source of the metering data (Elia)
3	Direction of transfer	String	Identification of the direction of flow (see Metering Concepts Manual). Possible values are: <ul style="list-style-type: none"> PROD: Production of active energy (flow from client to Elia)



			<ul style="list-style-type: none"> • CONS: Consumption of active energy (flow from client to Elia)
--	--	--	---

Table 16 CSV GEMP [dataG] fields

2.6.1.2.2. [dataR]

[dataR] contains the sum of metering data for all Access Points that are in the scope of responsibility of the BRP in each regulated region. Each [dataR] section in the message identifies the source of the metering data, the direction of the power flow and the region.

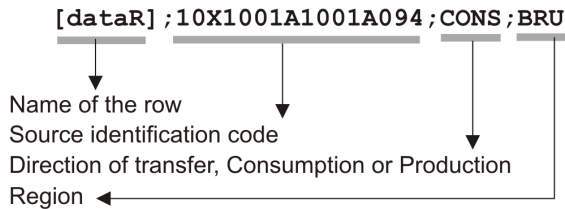

1	Name of the row	String	Fixed. Always [dataR]
2	Source identification code	String	EIC code of the source of the metering data (Elia).
3	Direction of transfer	String	Identification of the direction of flow (see Metering Concepts Manual). Possible values are: <ul style="list-style-type: none"> • PROD: Production of active energy (flow from client to Elia) • CONS: Consumption of active energy (flow from client to Elia)
4	Region	String	Field indicating the region over which the values are summed. Possible values are: <ul style="list-style-type: none"> • FLE: Flemish region • WAL: Wallonia region • BRU: Brussels region • FED: Federal region. This region contains all Access Points that are on the 380/220/150 kV network (independently of the physical location).

Table 17 CSV GEMP [dataR] fields

2.6.1.2.3. [dataS]

[dataS] – contains the sum of metering data for all Access Points that are in the scope of responsibility of the BRP in each regulated region and for each supplier. Each [dataS] section in the message identifies the source of the metering data, the direction of the power flow, the region and the energy supplier.

The [dataS] section is only contained in messages delivered to BRPs.

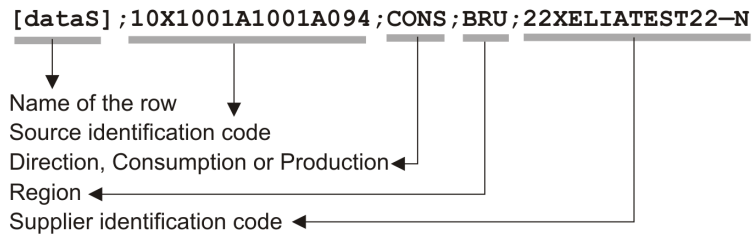

Field	Name	Data type	Comment
1	Name of the row	String	Fixed. Always [dataS]
2	Source identification code	String	EIC code of the source of the metering data (Elia)
3	Direction of transfer	String	Identification of the direction of flow (see Metering Concepts Manual). Possible values are: <ul style="list-style-type: none"> • PROD: Production of active energy (flow from client to Elia). • CONS: Consumption of active energy (flow from client to Elia).
4	Region	string	Field indicating the region over which the values are summed. Possible values are: <ul style="list-style-type: none"> • FLE: Flemish region • WAL: Wallonia region • BRU: Brussels region • FED: Federal region. This region contains all Access Points that are on the 380/220/150 kV grid (independently of the physical location).
6	Supplier identification code	String	EIC code of the supplier for which the values are summed.

Table 18 CSV GEMP [dataS] fields

2.6.1.3. [schedule]

The [schedule] section contains the actual metered values for the corresponding [data] section. Each [schedule] section identifies all the parameters used to describe the power as well as the actual power values.

[schedule];2005-03-07T23:00:00Z;1440;15;I;N;NC;ULP;VAR;False;16417.082;N;..

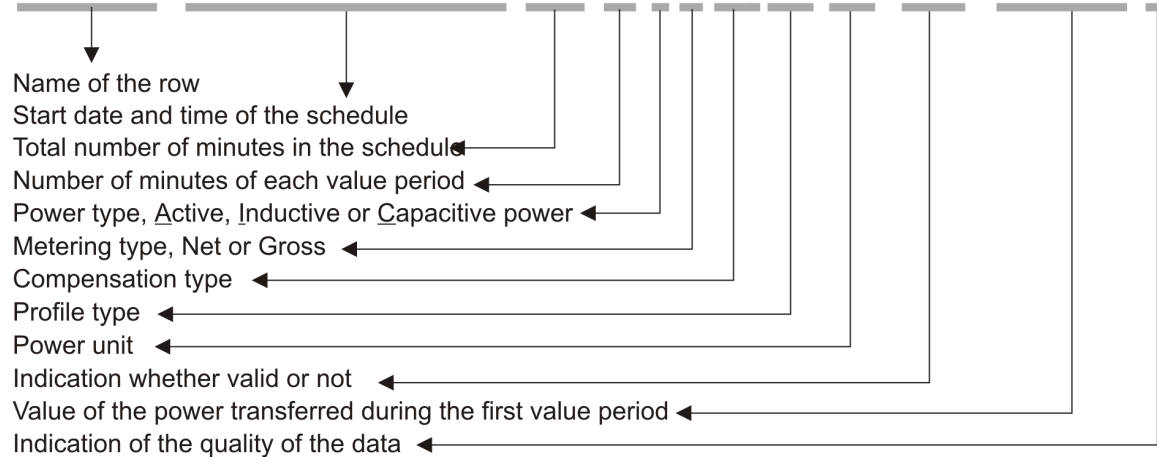

Each of these parameters is described in the Metering Manual Concept. The schedule section is linked with the [dataG], [dataR] or [dataS] section that precedes it. There can be several schedule lines for each type of data section.

The schedules are normally daily schedules, but any time period is in theory possible.

Field	Name	Data type	Comment
1	Name of the row	String	Fixed. Always [schedule]
2	Start date and time	Date	Start date and time of the schedule in ISO 8601 format
3	Duration	Integer	Total number of minutes in the schedule
4	Period	Integer	Number of minutes for each value period. Always 15.
5	Power type	String	Identification of the type of power (see Metering Concept Manual). Possible values are: <ul style="list-style-type: none"> • A: Active • I: Inductive • C: Capacitive • Only Active values are provided to BRPs.
6	Metering type	String	Indication as to whether the values are net, gross or specific (see Metering Concept Manual). Possible values: <ul style="list-style-type: none"> • N: Net • G: Gross • GG: "Green Gross" •
7	Compensation type	String	Indication as to whether the values compensated or not (see Metering Concept Manual).

			<p>Possible values:</p> <ul style="list-style-type: none"> • NC: Non-Compensated. Used for metering purposes. • C: Compensated. Used for billing purposes • A: Reserved for future use • CC: Compensated Corrected. Used for specific purposes
8	Profile type	string	<p>Indication of the load profile. This field is reserved for probable future use and has no significant meaning. Currently, values could be:</p> <ul style="list-style-type: none"> • ALP: Aggregated load profile, • ULP: Undefined load profile
9	Power unit	String	<p>Unit in which the power values are defined. Possible values are:</p> <ul style="list-style-type: none"> • KWT, KVR, • W, KW, MW, • VAR, KVAR, MVAR
10	Validation	Boolean	<p>Indication as to whether the values are valid or not (see Metering Concept Manual).</p> <p>Possible values are:</p> <ul style="list-style-type: none"> • True: validated by Elia • False: not validated by Elia
11 to 203 in steps of 2	Value	Unsigned Decimal	<p>Value of the transferred power. The value is always positive. The value is expressed in the defined unit and contains a maximum of 3 digits after the decimal point.</p>
12 to 204 in steps of 2	Quality	1 char	<p>Indication as to the quality of the metered data (see Metering Concept Manual).</p> <p>Possible values are:</p> <ul style="list-style-type: none"> • N: Normal • I: Inexact • S: Substituted (Estimated replacement).

Table 19 CSV GEMP [schedule] fields

2.6.2. XML GEMP

The summed metered data is supplied in a single message (contained in the <ARPAAllGemp> root element) which contains 3 sub sections:

```
<?xml version="1.0" encoding="iso-8859-1"?>
<ARPAAllGemp xmlns="http://www.elia.be/namespaces/public/evms/b2bmsg">
+ <ARPGemp>
+ <ARPRRegionGemp>
+ <ARPSupplierGemp>
</ARPAAllGemp>
```

Example 16 XML ARPALLGemp message root

- <ARPGemp> contains the global summed data
- <ARPRRegionGemp> contains the data summed per region
- <ARPSupplierGemp> contains the data summed per region and per supplier

2.6.2.1. ARPGemp

The <ARPGemp> element contains the global summation for all Access Points in Belgium that are in the scope of responsibility of the BRP. It consists of a <header>, which concerns the message and a <data-list> which contains the power transfer data.

```
<ARPGemp>
+ <header>
+ <data-list>
</ARPGemp>
```

Example 17 XML GEMP message <ARPGemp>

2.6.2.1.1. <header>

The single <header> element contains information about the sender of the message (Elia), the receiver, the time when the message was created and the type of message.

```
<header>
+ <sender> (contains fields identifying the sender)
+ <receiver> (contains fields identifying the receiver)
  <timestamp>2004-02-05T09:31:10Z</timestamp>
  <MsgGempType> (contains the type of message)
</header>
```

Example 18 XML GEMP message <header>

The contents of the <header> element are listed in the table below.

Element name	Element content	Content type	Cardinality	Description
<sender>	elements	<party> elements, (see section 3.2.1)	mandatory	Identification of message sender
<receiver>	elements		mandatory	Identification of message receiver
<timestamp>	text	date	mandatory	Time at which the message was created.
<MsgGempType>	text	string	optional	Fixed:GEMP ARP

Table 20 XML <header> element for ARPGemp elements

2.6.2.1.2. <data-list>

The <data-list> can contain one or more <data> sections. Each of the <data> sections identifies the direction of the transfer of power, by the optional <partyFrom> and <partyTo> elements, and a <schedule-list> that lists the actual power values.

```
<data-list>
  <data>
    + <partyFrom>
    + <partyTo>
    + <schedule-list>
  </data>
</data-list>
```

Example 19 XML GEMP message <data-list>

All the concepts related to these parameters are described in The Metering Manual Concept. The contents of each <data> section are listed in the table below.

Element name	Element content	Content type	Cardinality	Description
<partyFrom>	elements	<party> elements, (see section 3.2.1).	optional	Fields identifying the party FROM which the power is flowing.
<partyTo>	elements		optional	Fields identifying the party TO which the power is flowing.
<schedule-list>	elements	<schedule> elements (see section 0).	mandatory	Fields identifying the characteristics of the transferred power and their values.

Table 21 XML <data> element for ARPGemp elements

2.6.2.2. ARPRegionGemp

The <ARPRegionGemp> element contains the sum of metering data for all Access Points in the scope of responsibility of the BRP or Supplier in each regulated region. It consists of a <header>, which concerns the message and a <data-list> which contains the power transfer data.

```
<ARPRegionGemp>
+ <header>
+ <data-list>
</ARPRegionGemp>
```

2.6.2.2.1. <header>

The <header> element is mandatory. There is one <header> in the <ARPRegionGemp> element which identifies the sender and receiver of the message, time the message was created and the type of message.

```
<header>
+ <sender>
+ <receiver>
<timestamp>2004-07-02T10:23:08Z</timestamp>
<MsgGempType>
</header>
```

The contents of the <header> element are listed in the table below.

Element name	Element content	Content type	Cardinality	Description
<sender>	elements	<party> elements, (see section 3.2.1).	mandatory	Identification of message sender
<receiver>	elements		mandatory	Identification of message receiver
<timestamp>	text	date	mandatory	Time at which the message was created.
<MsgGempType>	text	string	optional	Fixed:GEMP ARP

Table 22 XML <header> element for ARPRegionGemp elements

2.6.2.2.2. <data-list>

The <data-list> element contains several <data> elements. Each of the <data> sections identify the direction of the transfer of power, by the optional <partyFrom> and <partyTo> elements, the summed power values per region and the region over which the values are summed.

```
<data-list>
  <data>
    + <partyFrom>
    + <partyTo>
    + <schedule-list>
      <region>BRU</region>
  </data>
</data-list>
```

The contents of each <data> section are listed in the table below.

Element name	Element content	Content type	Cardinality	Description
<partyFrom>	elements	<party> elements, (see section 3.2.1).	optional	Fields identifying the party FROM which the power is flowing.
<partyTo>	elements		optional	Fields identifying the party TO which the power is flowing.
<schedule-list>	elements	<schedule> elements (see section 0).	mandatory	Fields identifying the characteristics of the transferred power and their values.
<region>	text	string	mandatory	Field indicating the region over which the values are summed. <ul style="list-style-type: none"> • Possible values are: • FLE: Flemish region • WAL: Wallonia region • BRU: Brussels region • FED: Federal region. This region contains all Access Points that are on the 380/220/150 kV network (independently of the physical location).

Table 23 XML <data> element for ARPRegionGemp elements

2.6.2.3. ARPSupplierGemp

The <ARPSupplierGemp> element contains the sum of metering data for all Access Points in the scope of responsibility of the BRP in each regulated region and for each supplier. It consists of a <header>, which concerns the message and a <data-list> which contains the power transfer data.

```
<ARPSupplierGemp>
+ <header>
+ <data-list>
</ARPSupplierGemp>
```

2.6.2.3.1. <header>

The <header> element is mandatory. There is one <header> in the <ARPSupplierGemp> element which identifies the sender and receiver of the message, the time the message was created and the type of message.

```
<header>
+ <sender>
+ <receiver>
<timestamp>2004-07-02T10:23:08Z</timestamp>
<MsgGempType>
</header>
```

The contents of the <header> element are listed in the table below.

Element name	Element content	Content type	Cardinality	Description
<sender>	elements	<party> elements, (see section 3.2.1).	mandatory	Identification of message sender
<receiver>	elements		mandatory	Identification of message receiver
<timestamp>	text	date	mandatory	Time at which the message was created.
<MsgGempType>	text	string	optional	Fixed:GEMP ARP

Table 24 XML <header> element for ARPSupplierGemp elements

2.6.2.3.2. <data-list>

The <data-list> element contains several <data> elements. Each of the <data> sections identifies the direction of the transfer of power, by the optional <partyFrom> and <partyTo> elements, the summed power values, the region, and the supplier over which the values are summed.

```
<data-list>
  <data>
    + <partyFrom>
    + <partyTo>
    + <schedule-list>
    <region>BRU</region>
    <supplierEicCode>11SUPP-B-----P</supplierEicCode >
  </data>
</data-list>
```

The content of each <data> section is listed in the table below.

Element name	Element content	Content type	Cardinality	Description
<partyFrom>	elements	<party> elements, (see section 3.2.1).	optional	Fields identifying the party FROM which the power is flowing.
<partyTo>	elements		optional	Fields identifying the party TO which the power is flowing.
<schedule-list>	elements	<schedule> elements (see section 0).		Fields identifying the characteristics of the transferred power and their values.
<region>	text	string	mandatory	Field indicating the region over which the values are summed. Possible values are: <ul style="list-style-type: none"> • FLE: Flemish region • WAL: Wallonia region • BRU: Brussels region • FED: Federal region, which contains all Access Points on the 380/220/150 kV network (independently of the physical location).
<supplierEicCode>		string	mandatory	EIC Code of the supplier of the Access Point

Table 25 XML <data> element for ARPSupplierGemp elements



2.6.3. Excel GEMP

An example of a message GEMP is shown below. Note that this example's presentation shows the overall message structure rather than the complete contents. Only the first power values are shown in each of the Column values.

The Excel file contains one sheet named "000000000000000000": This sheet contains all information about the GEMP values for the given month:

The top rows contain information about the receiver, the "000000000000000000" code and "GEMP" and the time of creation (last update) of the message.

Subsequent areas of the sheet are divided into columns. The first lines of the columns contain information about the metering data (direction of the flow, power type, metering type, compensation type). The quarter hourly values give the power value and the quality for the mentioned metering data.

Company		Metersable		GEMP																		
000000000000000000		23-04-2014		Validation Stat: Non validated by Elia																		
Metersable type		Total		Total		Total		Total		Total		Total		Bru		Bru						
		Outgoing Active Gross		Outgoing Active Net		Outgoing Active Net		Incoming Active Gross		Incoming Active Net		Incoming Active Net		Outgoing Active Gross		Outgoing Active Net						
Monthly energy		Compensated	Quality	Compensated	Quality	Non Compensated	Quality	Compensated	Quality	Compensated	Quality	Non Compensated	Quality	Compensated	Quality	Compensated	Quality	Non Co				
Quarter hourly values		0 KWh		0 KWh		0 KWh		0 KWh		0 KWh		0 KWh		0 KWh		0 KWh						
Date	From	To	V	V	V	V	V	V	V	V	V	V	V	V	V	V	V					
01-01-2015	00:00	00:15	0	1	0	1	0	1	0	1	0	1	0	1	0	1	0	1	0	1	0	1
01-01-2015	00:15	00:30	0	1	0	1	0	1	0	1	0	1	0	1	0	1	0	1	0	1	0	1
01-01-2015	00:30	00:45	0	1	0	1	0	1	0	1	0	1	0	1	0	1	0	1	0	1	0	1
01-01-2015	00:45	01:00	0	1	0	1	0	1	0	1	0	1	0	1	0	1	0	1	0	1	0	1
01-01-2015	01:00	01:15	0	1	0	1	0	1	0	1	0	1	0	1	0	1	0	1	0	1	0	1
01-01-2015	01:15	01:30	0	1	0	1	0	1	0	1	0	1	0	1	0	1	0	1	0	1	0	1
01-01-2015	01:30	01:45	0	1	0	1	0	1	0	1	0	1	0	1	0	1	0	1	0	1	0	1
01-01-2015	01:45	02:00	0	1	0	1	0	1	0	1	0	1	0	1	0	1	0	1	0	1	0	1
01-01-2015	02:00	02:15	0	1	0	1	0	1	0	1	0	1	0	1	0	1	0	1	0	1	0	1
01-01-2015	02:15	02:30	0	1	0	1	0	1	0	1	0	1	0	1	0	1	0	1	0	1	0	1
01-01-2015	02:30	02:45	0	1	0	1	0	1	0	1	0	1	0	1	0	1	0	1	0	1	0	1
01-01-2015	02:45	03:00	0	1	0	1	0	1	0	1	0	1	0	1	0	1	0	1	0	1	0	1
01-01-2015	03:00	03:15	0	1	0	1	0	1	0	1	0	1	0	1	0	1	0	1	0	1	0	1
01-01-2015	03:15	03:30	0	1	0	1	0	1	0	1	0	1	0	1	0	1	0	1	0	1	0	1
01-01-2015	03:30	03:45	0	1	0	1	0	1	0	1	0	1	0	1	0	1	0	1	0	1	0	1
01-01-2015	03:45	04:00	0	1	0	1	0	1	0	1	0	1	0	1	0	1	0	1	0	1	0	1
01-01-2015	04:00	04:15	0	1	0	1	0	1	0	1	0	1	0	1	0	1	0	1	0	1	0	1
01-01-2015	04:15	04:30	0	1	0	1	0	1	0	1	0	1	0	1	0	1	0	1	0	1	0	1
01-01-2015	04:30	04:45	0	1	0	1	0	1	0	1	0	1	0	1	0	1	0	1	0	1	0	1
01-01-2015	04:45	05:00	0	1	0	1	0	1	0	1	0	1	0	1	0	1	0	1	0	1	0	1
01-01-2015	05:00	05:15	0	1	0	1	0	1	0	1	0	1	0	1	0	1	0	1	0	1	0	1
01-01-2015	05:15	05:30	0	1	0	1	0	1	0	1	0	1	0	1	0	1	0	1	0	1	0	1
01-01-2015	05:30	05:45	0	1	0	1	0	1	0	1	0	1	0	1	0	1	0	1	0	1	0	1
01-01-2015	05:45	06:00	0	1	0	1	0	1	0	1	0	1	0	1	0	1	0	1	0	1	0	1
01-01-2015	06:00	06:15	0	1	0	1	0	1	0	1	0	1	0	1	0	1	0	1	0	1	0	1
01-01-2015	06:15	06:30	0	1	0	1	0	1	0	1	0	1	0	1	0	1	0	1	0	1	0	1
01-01-2015	06:30	06:45	0	1	0	1	0	1	0	1	0	1	0	1	0	1	0	1	0	1	0	1

Example 20 Excel (XLSX) Global Elia Metered Position (GEMP) message

The GEMP consists of the following sections:

- A header section.
- A set of columns headers.
- A set of columns values.

2.6.3.1. Header

The header contains reference of the "GEMP" point and the receiver.

	A	B	C	D
1	Company	22XXXXXXXXXXXXC		Test company
2	Meterable	000000000000000000		GEMP
3	Last Update	23-04-2014		
4	Validation Status	Non validated by Elia		
5				

Figure 8 Excel GEMP header

Excel Cell	Name	Data type	Comment
B1:C1 (merged cells)	Receiver identification code	String	EIC company code of the receiver of the message.
D1:F1 (merged cells)	Receiver name	String	Name of the company receiver of the message. Note: this is a "display name" that can be different from the official name of the company
B2:C2 (merged cells)	GEMP identification code	String	Fixed: "000000000000000000"
D2:F2 (merged cells)	GEMPname	String	Fixed: "GEMP"
B3:C3 (merged cells)	Last update date	Date and time	Date and time of the creation of the highest version of this document.
B4:C4 (merged cells)	Validation	String	Indication as to whether the values are valid or not (see Metering Manual Concepts). Possible values are: <ul style="list-style-type: none"> • "Validated by Elia" • "Non-validated by Elia"

Table 26 Excel GEMP header fields

2.6.3.2. Column headers

Same as the Access Point described in Section 2.1.3.2.

2.6.3.3. Column values

Same as the Access Point described in Section 2.1.3.3.

2.7. Imbalance

Electricity cannot be stored in massive quantities at a reasonable price.

Therefore, one of the objectives of Elia, as Transport System Operator (TSO), is to maintain the Elia electrical grid "in balance": practically, on the Elia grid, the production (injection) of electricity must be continually adjusted with the consumption (offtake) of electricity.

In more general terms, the energy coming on the Elia grid must always be equal with the energy leaving the Elia grid. The energy can be produced or consumed in Belgium but also imported from or exported to other European countries.

The BRP "injects" ("IN") and "offtakes" ("OUT") electricity on the Elia grid. The sum of these "IN" and "OUT" constitutes the "balance perimeter" of the BRP.

To be sure that BRP respects the golden rule on his balance perimeter, Elia calculates the Imbalance settlement for each quarter: Per quarter hour, this is the difference between:

- IN: the quantity of energy coming in the balance perimeter of the BRP and
- OUT: the energy going out the balance perimeter of the BRP.

E.g., Injection on the left side is in balance with offtake on the right side:

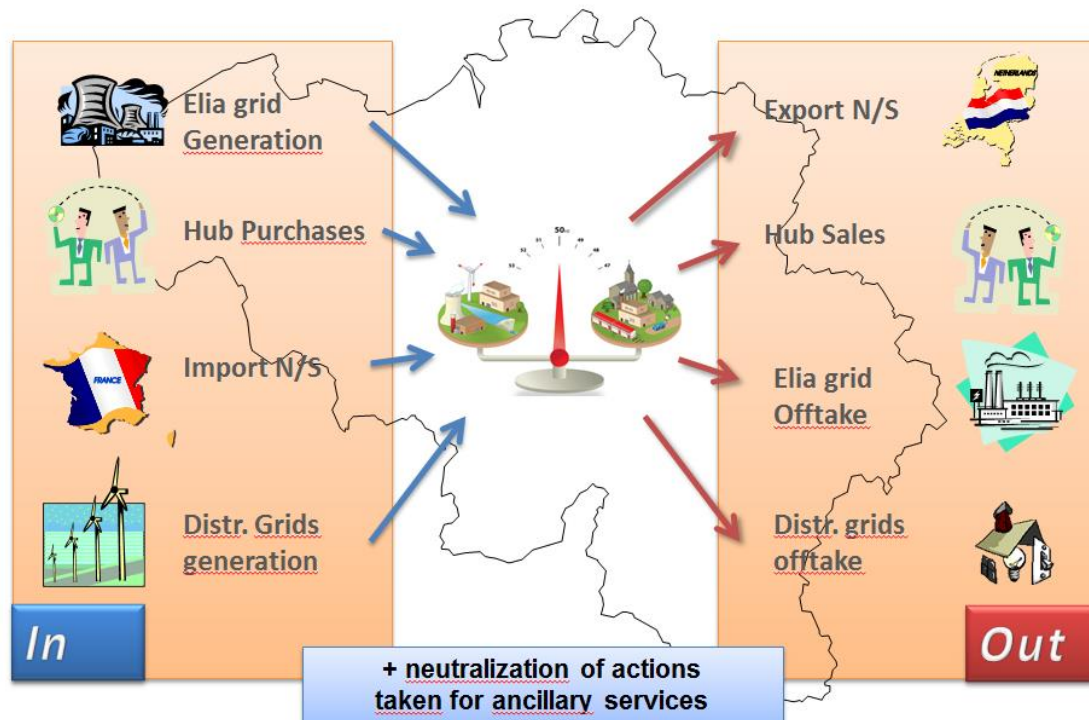

Figure 9: Balance perimeter

IN = The total injection of the BRP equals the sum of many components, for that quarter hour:

- all imports (for this BRP) from other European grid
- all injections at the injection Points allocated to the BRP
- all distribution injection positions allocated to the BRP
- all injections by internal transfers of nominated by the BRP (“as the buyer”)

OUT = The Total offtake of the BRP equals the sum of many components, for that quarter hour:

- all exports (for this BRP) to other European grid
- all offtakes at the offtake points allocated to the BRP
- all distribution offtake positions allocated to the BRP
- all offtakes by internal transfers of energy nominated by the BRP (“as the seller”)

As the difference of “classical” messages explained before in this document, the Imbalance message contains components. A component within a message represents a business flow. The energy is measured per quarter hour. For each quarter hour, the “balance perimeter” of the BRP may contain many components.

Each component is supposedly well known by the recipient and published to facilitate the analysis in case of error: its detailed business meaning is not described in this document. The list of components is given in “2.7.1. Imbalance Components”.

Full details on all the descriptive fields and the possible values they can take can be found in section 2.7.6 (for the CSV format messages), section 2.7.7 (for the XML format messages) and section 2.7.8 (for the XLSX format messages).

2.7.1. Imbalance components

The business concepts behind each component are explained in the contractual document given to the BRP. This manual gives only a brief description.

The imbalance components that can be counted to the BRP are:

Component	Description
CrossBorderExportTotal	Total cross border export position of the BRP: Total energy going out the BRP balance perimeter on the Elia grid
CrossBorderImportTotal	Total cross border import position of the BRP: Total energy coming in the BRP balance perimeter on the Elia grid
HubSalesTotal	Total of the sales of the BRP on Elia Hub (included its sales on the Power Exchanges)
HubPurchasesTotal	Total of the purchase (buy) of the BRP on Elia Hub (included its purchases on the Power Exchanges)
aFRRUpCorrTotal	Compensation for activation of aFRR upward (positive).
aFRRDownCorrTotal	Compensation for activation aFRR downward (negative).
mFRRnonCipuBrpSourceCorrTotal	Compensations of the BRP _{source} of a Delivery Point performed in the context of an mFRR non CIPU units (DP _{PG}) activation (Upward & Downward). The compensation's amount corresponds to the energy delivered by the activated DP _{PG} falling under a ToE regime.
mFRRnonCipuBrpBspCorrTotal	Compensations of the BRP _{BSP} performed in the context of an mFRR non CIPU units (DP _{PG}) activation (Upward & Downward). This component corresponds to the mFRRnonCipuBrpBspDownCorr component minus the mFRRnonCipuBrpBspUpCorr component.
mFRRnonCipuBrpBspUpCorr	Compensations of the BRP _{BSP} performed in the context of mFRR non CIPU units (DP _{PG}) upward activations. The compensation's amount corresponds to the difference between the upward energy requested by Elia and the energy delivered by the activated DP _{PG} falling under a ToE regime.
mFRRnonCipuBrpBspDownCorr	Compensations of the BRP _{BSP} performed in the context of mFRR non CIPU units (DP _{PG}) downward activations. The compensation's amount corresponds to the difference between the downward energy requested by Elia and the energy delivered by the activated DP _{PG} falling under a ToE regime.
mFRRnonCipuTotal	Sum of the compensations (BRP _{source} & BRP _{BSP}) performed in the context of mFRR non CIPU units (DP _{PG}) activations (Upward & Downward). This component corresponds to the sum of the mFRRnonCipuBrpSourceCorrTotal & mFRRnonCipuBrpBspCorrTotal components.
OtherUpCorrTotal	Additional Upward balancing compensation: This component represents additional upward compensation in the case of a specific agreement.
OtherDownCorrTotal	Additional Downward balancing compensation: This component represents additional downward compensation in the case of a specific agreement.
DGOInjectionTotal	Total of injection of the BRP for all DGO Network
DGOOfftakeTotal	Total of offtake of the BRP for all DGO Network
DGOLossesTotal	Total of losses of the BRP related to its clients on DGO Networks
DGOInjection	Allocation injection of the BRP for one DGO Network
DGOOfftake	Allocation offtake of the BRP for one DGO Network
DGOLoopLossesTotal	Total of Loop losses (Clearing difference) for the DGO Network attributed to the BRP

DGOLoopLosses	Loop losses (Clearing difference) of a DGO Network
CDSInjectionTotal	Total of injection of the BRP for all CDS Network
CDSOfftakeTotal	Total of offtake of the BRP for all CDS Network
CDSLosesTotal	Total of losses of the BRP related to its clients on CDS Networks
CDSInjection	Allocation injection of the BRP for one CDS Network
CDSOfftake	Allocation offtake of the BRP for one CDS Network
CDSLoopLossesTotal	Total of Loop losses Clearing Difference for the CDS network attributed to the BRP
CDSLoopLosses	Loop losses (Clearing difference) of a CDS Network
TSOOfftakeTotal	Total offtake of the BRP for its clients on the TSO network
TSOInjectionTotal	Total injection of the BRP from its clients on the TSO network
TSOLosesTotal	Total losses of the BRP related to its clients on the TSO network
ImbalanceResultofthePooling	The imbalance of the pooling. (The Imbalance counted to the BRP "head of Pool". Is the sum of individual imbalance of the member of the pool in case of pooling agreement)
OffshoreInterconnectionOfftakeTotal	Total offtake of the BRP _{O.I.} associated with this Offshore Interconnection
OffshoreInterconnectionInjectionTotal	Total injection of the BRP _{O.I.} associated with this Offshore Interconnection
ImbalanceRecipient	Total Imbalance of the BRP
mFRRDPpg&DA/IDBrpBspCorrTotal	Compensations of the BRP _{BSP} performed in the context of mFRR DP _{PG} (non CIPU units) activations (Upward & Downward) in DA/ID. This component corresponds to the mFRRDPpg&DA/IDDownBrpbspCorr component minus the mFRRDPpg&DA/IDUpBrpbspCorr component.
mFRRDPpg&DA/IDBrpSourceCorrTotal	Compensations of the BRP _{SOURCE} performed in the context of mFRR DP _{PG} (non CIPU units) activations (Upward & Downward) in DA/ID.
mFRRDPpg&DA/IDDownBrpbspCorr	Compensations of the BRP _{BSP} performed in the context of mFRR DP _{PG} (non CIPU units) downward activations in DA/ID.
mFRRDPpg&DA/IDTotal	Sum of the compensations (BRP _{SOURCE} & BRP _{BSP}) performed in the context of mFRR DP _{PG} (non CIPU units) activations (Upward & Downward) in DA/ID. This component corresponds to the sum of the mFRRDPpg&DA/IDBrpSourceCorrTotal & mFRRDPpg&DA/IDBrpBspCorrTotal components.
mFRRDPpg&DA/IDUpBrpbspCorr	Compensations of the BRP _{BSP} performed in the context of mFRR DP _{PG} (non CIPU units) upward activations in DA/ID.
mFRRDPsuUpCorr Total	Compensations of the BRP performed in the context of mFRR DP _{SU} (former CIPU units) upward activations. This component together with the "RedispatchingUpCorr Total" component are replacing the former "mFRRCipuAndCipuUpCorrTotal" component.
mFRRDPsuDownCorr Total	Compensations of the BRP performed in the context of mFRR DP _{SU} (former CIPU units) downward activations. This component together with the "RedispatchingDownCorr Total" component are replacing the former "mFRRCipuAndCipuDownCorrTotal" component.

RedispatchingUpCorr Total	Compensations of the BRP performed in the context of Redispatching upward activations. This component together with the "mFRRDPsuUpCorr Total" component are replacing the former "mFRRCipuAndCipuUpCorrTotal" component.
RedispatchingDownCorr Total	Compensations of the BRP performed in the context of Redispatching downward activations. This component together with the "mFRRDPsuDownCorr Total" component are replacing the former "mFRRCipuAndCipuDownCorrTotal" component.

Remarks:

This list can always vary when new components of the Imbalance could be created based on new market rules. Elia does not guarantee the order of components within the message.

2.7.2. Imbalance components criteria's

In the following list the columns must be understood as:

- **Component:** See Section "2.7.1 Imbalance components"
- **Flow direction:** the flow of electricity within the BRP Balance perimeter:
 - **IN:** the quantity of energy coming in the balance perimeter of the BRP
 - **OUT:** the energy going out the balance perimeter of the BRP
- **Possible negative value?** Normally the electricity follows the flow indicated within the column 'Flow direction', but exceptionally electricity can flow in the other direction. In this case, the electricity quarter value is negative

Component	Flow direction	Possible negative values?
CrossBorderExportTotal	Out	No
CrossBorderImportTotal	In	No
HubSalesTotal	Out	No
HubPurchasesTotal	In	No
aFRRUpCorrTotal	Out	No
aFRRDownCorrTotal	In	No
OtherUpCorrTotal	Out	No
OtherDownCorrTotal	In	No
DGOInjectionTotal	In	No
DGOOfftakeTotal	Out	No
DGOLossesTotal	Out	Yes
DGOInjection	In	No
DGOOfftake	Out	No
DGOLoopLossesTotal	Out	Yes
DGOLoopLosses	Out	Yes
CDSInjectionTotal	In	No
CDSOfftakeTotal	Out	No
CDSLosesTotal	Out	Yes
CDSInjection	In	No
CDSOfftake	Out	No
CDSLoopLossesTotal	Out	Yes
CDSLoopLosses	Out	Yes
TSOOfftakeTotal	Out	No
TSOInjectionTotal	In	No
TSOLosesTotal	Out	No
DchCompensationTotal	Out	Yes
ImbalanceResultofthePooling	In	Yes
OffshoreInterconnectionOfftakeTotal	Out	No
OffshoreInterconnectionInjectionTotal	In	No
ImbalanceRecipient	In	Yes
mFRRDPpg&DA/IDBrpBspCorrTotal	In	Yes

mFRRDPpg&DA/IDBrpSourceCorrTotal	In	Yes
mFRRDPpg&DA/IDDownBrpbspCorr	In	No
mFRRDPpg&DA/IDTotal	In	Yes
mFRRDPpg&DA/IDUpBrpbspCorr	Out	No
mFRRDPsuUpCorr Total	Out	No
mFRRDPsuDownCorr Total	In	No
RedispatchingUpCorr Total	Out	No
RedispatchingDownCorr Total	In	No

2.7.3. Imbalance components added parameters

In the following list the columns must be understood as:

- **Component:** See section 2.7.1 "Imbalance components"
- **Party/area:** Each component can be general and referenced to the BRP: this is the "party". For example, all border import of the BRP. But some components can be also detailed per "area". For example, a component on a distribution grid has also the grid area code.
- **Code:** This code can be:
 - The BRP EIC code
 - The area code
 - A specific EIC code

Component	Party/Area	Code
CrossBorderExportTotal	Party	BRP EIC code
CrossBorderImportTotal	Party	BRP EIC code
HubSalesTotal	Party	BRP EIC code
HubPurchasesTotal	Party	BRP EIC code
aFRRUpCorrTotal	Party	BRP EIC code
aFRRDownCorrTotal	Party	BRP EIC code
OtherUpCorrTotal	Party	BRP EIC code
OtherDownCorrTotal	Party	BRP EIC code
DGOInjectionTotal	Area	ALL DGO EIC code: 22YBE-ALLDSO---0
DGOOfftakeTotal	Area	ALL DGO EIC code: 22YBE-ALLDSO---0
DGOLossesTotal	Area	ALL DGO EIC code: 22YBE-ALLDSO---0
DGOInjection	Area	DGO Network EAN code (see "2.7.1.4 Distribution grid area codes ")
DGOOfftake	Area	DGO Network EAN code (see "2.7.1.4 Distribution grid area codes ")
DGOLoopLossesTotal	Area	ALL DGO EIC code: '22YBE-ALLDSO---0
DGOLoopLosses	Area	DGO Network EAN code
CDSInjectionTotal	Area	ALL CDS EIC code: 22YBE-ALLCDS---3
CDSOfftakeTotal	Area	ALL CDS EIC code: 22YBE-ALLCDS---3
CDSLosesTotal	Area	ALL CDS EIC code: 22YBE-ALLCDS---3
CDSInjection	Area	CDS Network EAN code
CDSOfftake	Area	CDS Network EAN code
CDSLoopLossesTotal	Area	ALL CDS EIC code: 22YBE-ALLCDS---3
CDSLoopLosses	Area	CDS Network EAN code
TSOOfftakeTotal	Area	Total on the Elia network: 22YBE-TSO-----9

TSOInjectionTotal	Area	Total on the Elia network: 22YBE-TSO-----9
TSOLossesTotal	Area	Total on the Elia network: 22YBE-TSO-----9
ImbalanceResultofthePooling	Party	BRP EIC code
OffshoreInterconnectionOfftakeTotal	Party	ALL OIP EIC code: 22YBE-ALLOIP---F
OffshoreInterconnectionInjectionTotal	Party	ALL OIP EIC code: 22YBE-ALLOIP---F
ImbalanceRecipient	Party	Can be EIC code of the BRPs member of the pool or BRP EIC code
mFRRDPpg&DA/IDBrpBspCorrTotal	Party	BRP EIC code
mFRRDPpg&DA/IDBrpSourceCorrTotal	Party	BRP EIC code
mFRRDPpg&DA/IDDownBrpbspCorr	Party	BSP EIC code
mFRRDPpg&DA/IDTotal	Party	BSP EIC code
mFRRDPpg&DA/IDUpBrpbspCorr	Party	BRP EIC code
mFRRDPsuUpCorr Total	Party	BRP EIC code
mFRRDPsuDownCorr Total	Party	BRP EIC code
RedispatchingUpCorr Total	Party	BRP EIC code
RedispatchingDownCorr Total	Party	BRP EIC code

2.7.4. Distribution grid area codes

The code used in the metering system refers to its DGO network EAN (these EAN codes are also used in the nomination system).

See:

https://www.elia.be/-/media/project/elia/elia-site/customers/customer-tools/nominations/20210201_list-of-distribution-grids_en.pdf for the complete list.

Currently following DGO Network are available:

541453179928225270 - AIEG
541453175526064631 - AIESH
541453105692690617 - GASELWEST
541453199767702817 - Fluvius West
541453174796694517 - IMEWO
541453116958254573 - Fluvius Limburg
541453126054018733 - INTERGEM
541453182932680843 - Fluvius Antwerpen
541453118978518246 - IVEKA
541453117858523134 - IVERLEK
541453152233523132 - ORES (BRABANT WALLON)
541453182435244320 - ORES (EST)
541453122843569516 - ORES (HAINAUT ELECTRICITE)
541453114573305847 - ORES (LUXEMBOURG)
541453137733095884 - ORES (MOUSCRON)
541453170109194514 - ORES (NAMUR)
541453169685000180 - ORES (VERVIERS)
541453175169008979 - PBE
541453131260317563 - SIBELGA
541453175605410335 - SIBELGAS
541453199449664358 - RESA
541453135778772500 - Réseau D'Energies de Wavre

2.7.5. Closed Distribution System area codes

The code used in the metering system refers to its CDS network EAN (these EAN codes are also used in the nomination system).

See:

https://www.elia.be/-/media/project/elia/elia-site/customers/customer-tools/nominations/20230701_active_closed_distribution_grids_en.pdf for the complete list.

Currently following CDS Network are available:

541453185522017586 - DNB Brussels Airport _ Zaventem
541453176864035840 - BASF Antwerpen
541453173171146450 - ArcelorMittal Belgium _ Seraing
541453118417028657 - ArcelorMittal Belgium_Ramet
541453112214433928 - INEOS Oxide Utilities _ Zwijndrecht
543000348105915000 - NYRSTAR Belgium _ Balen

2.7.6. CSV Imbalance Value

Imbalance messages contain a [header] row, a [data] row describing the component and [schedule] sections. An example of a CSV Imbalance message is shown below:

```
[header];10X1001A1001A094;22XBRPA-----A;2015-09-14T22:00:00Z;IMBALANCE;10;Final
[data];CrossBorderExportTotal;22XBRPA-----A;OUT
[schedule];2015-07-31T22:00:00Z;1440;15;A;N;C;ALP;KW;695939,469;N;
[end]
```

Example 21 CSV Imbalance message

The Imbalance Message consists of the following sections:

- a [header] section
- [data] section
- [schedule] section
- [end] – which is the last line indicating the end of the message. All characters following [end] must be ignored.

2.7.6.1. [header]

The [header] row contains information about the sender and the receiver of the message as well as the time of creation, the version number, state of the message and the fact that this is an Imbalance message. There is only one [header] row in the message.

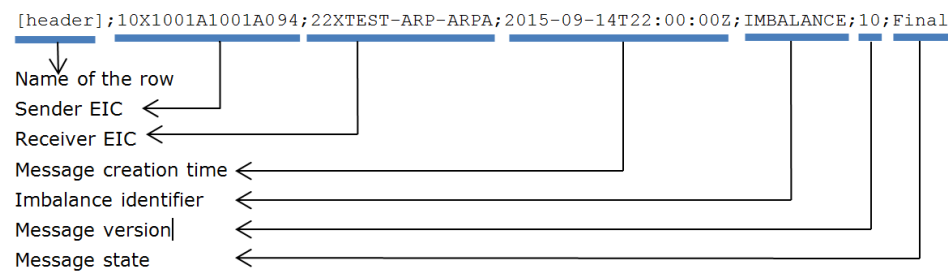

Field	Name	Data type	Comment
1	Name of the row	String	Fixed. Always [header]
2	Sender identification code	String	EIC code (Energy Identification Code) of the TSO (Elia): 10X1001A1001A094
3	Receiver identification code	String	EIC code (Energy Identification Code) of the receiver of the message
4	Message creation time	Date	Date and time of the file creation in Iso format
5	Message type	String	Fixed. Always IMBALANCE
6	Version	String	The version of the message: An integer within range [1...999]. Note: The first message sent is not guaranteed to have version 1.
7	Message status	String	Indicate if the message is 'Intermediate', 'Final' or 'FinalModified'

Table 27 CSV Imbalance [header] fields



2.7.6.2. [data]

A [data] row contains information about the component and related criteria. A [data] section is always followed by at least one [schedule] section. There are several [data] sections that correspond to different components.

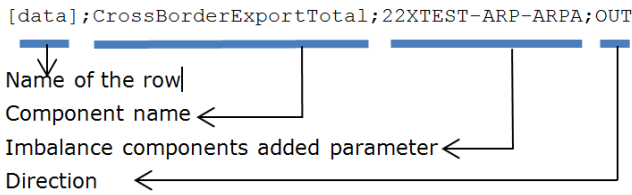

Field	Name	Data type	Comment
1	Name of the row	String	Fixed. Always [data]
2	Component	String	Name of the component: See "2.7.1 Imbalance Components"
3	Party/Area	String	The party or Area related to the component: see "2.7.3 Imbalance components added parameters"
3	Direction of Power flow	String	Identification of the direction of flow (see section see "2.7.2 Imbalance components "). Possible values are: <ul style="list-style-type: none"> OUT: the energy is going out the BRP Balance perimeter IN: the energy is coming in the BRP balance perimeter

Table 28 CSV Imbalance message [data] fields

2.7.6.3. [schedule]

A [schedule] section contains the power values transferred over the specified time period and identifies the type of power. The Time period constitutes 1 day of 23, 24 or 25 hours. For any component identified in the [data] section, there can be a number of [schedules]. A [schedule] is always related to a parent [data] section. Each [data] section should have one [schedule] section for each day of the covered month but any time period is theoretically possible. The fields contained in the [schedule] are listed below; the general meaning of these fields can be found in section Metering Concept Manual.

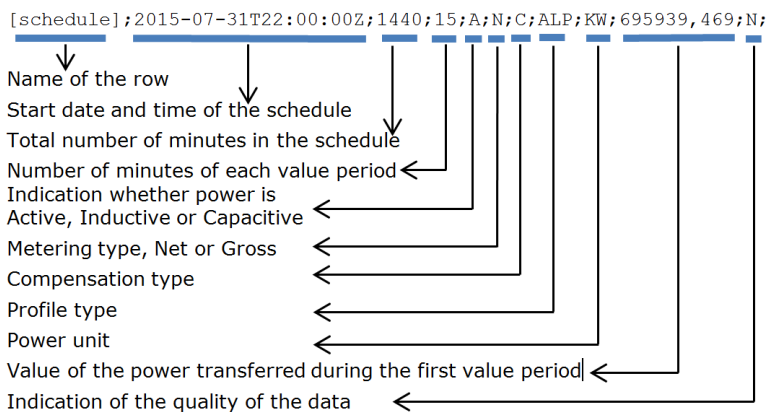

Field	Name	Data type	Comment
1	Name of the row	String	Fixed. Always [schedule]
2	Start date and time	Date	Start date and time of the schedule in ISO 8601 format.
3	Duration	Integer	Total number of minutes in the schedule.
4	Period	Integer	Number of minutes for each value period. Always 15.
5	Power type	String	<p>Identification of the type of power* (see Metering Concept Manual).</p> <p>Possible values are:</p> <ul style="list-style-type: none"> • A: Active • I: Inductive • C: Capacitive <p>* Normally only Active power type are part of the Imbalance message but theoretically other power type could also exist</p>
6	Metering type	String	<p>Indication as to whether the values are net or gross* or specific (see Metering Concept Manual).</p> <p>Possible values are:</p> <ul style="list-style-type: none"> • N: Net • G: Gross • GG: "Green Gross" <p>* Normally only Net metering type are part of the Imbalance message but theoretically other metering type could also exist</p>
7	Compensation type	String	<p>Indication as to whether the values are compensated or not* (see Metering Concept Manual).</p> <p>Possible values are:</p> <ul style="list-style-type: none"> • NC: Non-Compensated. Used for metering purposes. • C: Compensated. Used for billing purposes • A: Reserved for future use • CC: Compensated Corrected Used for specific purposes <p>* Normally only Compensated are part of the Imbalance message but theoretically other Compensation type could also exist</p>
8	Profile type	String	<p>Indication of the load profile*. This field is reserved for probable future use and has no significant meaning. Currently, values could be:</p> <ul style="list-style-type: none"> • ALP: Aggregated load profile

			<ul style="list-style-type: none"> • ULP: Undefined load profile * Normally only ALP are part of the Imbalance message but theoretically ULP type could also exist
9	Unit	String	<p>Unit in which the metered values are defined.</p> <p>Normally always KW</p>
10 to 202 in steps of 2	Value	Signed Decimal	<p>Value of the metered quantity in the unit defined in Field 9 above with a maximum of 3 digits after the decimal point.</p> <ul style="list-style-type: none"> • If the value is positive then no "+" sign is added • If the value is negative then "-" sign is added
11 to 203 in steps of 2	Quality	1 char	<p>Indication as to the quality of the metered data (see Metering Concept Manual).</p> <p>Possible values are:</p> <ul style="list-style-type: none"> • N: Normal • I: Inexact • S: Substituted (Estimated replacement).

Table 29 CSV Imbalance message [schedule] fields

2.7.7. XML Imbalance

The current Imbalance message respects the **CIM IEC standard 62325-451-4**

The structure therefore is briefly explained in this document but whole description is available on the IEC web store: <https://webstore.iec.ch/publication/29116>

The XSD Schema reference is available on "3.1 Reference XSD".

```
<EnergyAccount_MarketDocument xsi:schemaLocation="urn:iec62325.351:tc57wg16:451-4:energyaccountdocument:4:0 iec62325-451-4-settlement_v4.xsd"
xmlns="urn:iec62325.351:tc57wg16:451-4:energyaccountdocument:4:0"
xmlns:xsi="http://www.w3.org/2001/XMLSchema-instance">
</EnergyAccount_MarketDocument>
```

Example 22 XML Imbalance message root

The message begins with information about the sender of the message (Elia) and the receiver as well as the time when the message was created plus some information about the state of this message: This header is valid for all the Time Series.

Remark: the XML comments indicated in the message below are for the reader comprehension and are available in the message sent by Elia.

```
<mRID>IMB_20150801_20150831</mRID><revisionNumber>10</revisionNumber>
<type>A12<!--Imbalance report--></type>
<docStatus><value>A02</value></docStatus><!--Final-->
<process.processType>A06</process.processType> <!--Imbalance settlement-->
<process.classificationType>A01</process.classificationType> <!--Detail-->
<sender_MarketParticipant.mRID
codingScheme="A01">10X1001A1001A094</sender_MarketParticipant.mRID>
<sender_MarketParticipant.marketRole.type>A04</sender_MarketParticipant.marketRole.type>
<receiver_MarketParticipant.mRID codingScheme="A01">22XBRPA-----
A</receiver_MarketParticipant.mRID>
<receiver_MarketParticipant.marketRole.type>A08</receiver_MarketParticipant.marketRole.type>
<!--Balance responsible party-->
<createdDateTime>2015-09-14T22:00:00Z</createdDateTime>
<period.timeInterval>
    <start>2015-07-31T22:00Z</start>
    <end>2015-08-30T22:00Z</end>
</period.timeInterval>
<domain.mRID codingScheme="A01">10YBE-----2</domain.mRID>
```

Example 23 XML Imbalance message header

2.7.7.1. XML Imbalance Header fields

The following header fields are mandatory and are listed in the table below.

Element name	Content type	Description
mRID	String [1..35]	The unique identification of the document. Currently: "IMB_[First day of the period covered:YYYYMMDD]_[Last day of the covered period:YYYYMMDD]" Example: IMB_20150801_20150831 Please note that this mRID structure is not guaranteed. Any implementation should only refer to this mRID to determine if this message instance was already treated or not.
revisionNumber	Integer [1...999]	The version number of the document: It is not guaranteed that first document received by the BRP has version number 1. A more recent document has a higher version number
type	String [3]	Fixed. Always A12 (Imbalance document)
docStatus	String [3]	The status of the Imbalance document. Possible values: <ul style="list-style-type: none"> • A01 - Intermediate • A02 - Final • A03 - Final Modified
process.processType	String [3]	The type of the Imbalance document. Possible values: <ul style="list-style-type: none"> • A04 - System Operation closure • A05 - Metered data aggregation • A06 - Imbalance settlement • A99 - Real-Time DGO Allocation (see) • Normally only A06 is part of the Imbalance message but theoretically other processType could also exist
process.classificationType	String [3]	The classification mechanism used to group a set of objects together within a business process. Possible values: <ul style="list-style-type: none"> • A01 - Detail • A02 - Summary Normally only A01 is part of the Imbalance message but theoretically other classificationType could also exist
sender_MarketParticipant.mRID	codingScheme: String [3] Value: String [16]	Fixed: <ul style="list-style-type: none"> • codingScheme: A01 (EIC) • 10X1001A1001A094 (Elia EIC)
sender_MarketParticipant.marketRole.type	String [3]	Fixed: Always A04 (System operator)
receiver_MarketParticipant.mRID	codingScheme: String [3]	<ul style="list-style-type: none"> • codingScheme: Fixed A01 (EIC) • Value : EIC code of the BRP

	Value: String [16]	
receiver_MarketParticipant.marketRole.type	String [3]	Fixed: Always A08 (Balance Responsible Party / BRP)
createdDateTime	Date and time	Time at which the message was created (in UTC time).
period.timeInterval	Start / End: Date	Covered Period: Normally this is exactly one month (in UTC time). Example for the month August 2015: Start time is 31/7/2015 at 22h. End time is 31/8/2015 at 22h Any period is theoretically possible.
Domain.mRID	codingScheme: String [3] Value: String [16]	Fixed: Always <ul style="list-style-type: none"> codingScheme: A01 (EIC) 10YBE-----2 (Belgian Area)

Table 30 XML headers elements for Imbalance messages

The <TimeSeries> element describes the flow of the power for one component and related criteria and the schedule of actual power values.

Elia does not guarantee the order of Timeseries within the message.

```
<TimeSeries>
<mRID>A03-22XBRPA-----A</mRID>
<businessType>A03</businessType>
<!--OUT=Total export position of the BRP: Total energy going out the BRP balance perimeter on the Elia grid - IN=Total import position of the BRP: Total energy coming in the BRP balance perimeter on the Elia grid-->
<product>8716867000016</product>
<objectAggregation>A03</objectAggregation>
<area_Domain.mRID codingScheme="A01">10YBE-----2</area_Domain.mRID>
<marketParticipant.mRID codingScheme="A01">22XBRPA-----A
</marketParticipant.mRID>
<measure_Unit.name>KWT</measure_Unit.name>
<Period>
</TimeSeries>
```

Example 24 XML Imbalance message TimeSeries

The general meaning of these fields is given in The Metering Concept Manual. All elements are listed in the table below.

Element name	Content type	Description
mRID	String [1..35]	Time series unique identification within the message
businessType	String [3]	Fields identifying the characteristics of the component : See table below
product	String [1..35]	Fixed. Always 8716867000016 - Active Power
objectAggregation	String [3]	Fixed. Always A03

area_Domain.mRID	String [1..18]	Based on the table here below, can be an EAN or EIC code of the Area
marketParticipant.mRID	String [1..18]	Based on the table here below, is the EIC code of the Party
measure_Unit.name	String [3]	Power unit. Always KWT
Period	See "2.7.7.2 XML Imbalance Period Fields"	

Table 31 XML <data> element for Imbalance messages

Component	Business Type	Flow direction	Aggregation	Party/area	XML Grouping
HubPurchasesTotal	A02	In	By Party	BRP EIC code	Grouped
HubSalesTotal	A02	Out	By Party	BRP EIC code	
CrossBorderExportTotal	A03	Out	By Party	BRP EIC code	Grouped
CrossBorderImportTotal	A03	In	By Party	BRP EIC code	
CDSInjection	A14	In	By Area	CDS Network EAN code	Grouped
CDSOfftake	A14	Out	By Area	CDS Network EAN code	
CDSInjectionTotal	A14	In	By Area	ALL CDS EIC code: 22YBE-ALLCDS---3	Grouped
CDSOfftakeTotal	A14	Out	By Area	ALL CDS EIC code: 22YBE-ALLCDS---3	
DGOInjection	A14	In	By Area	DGO Network EAN code	Grouped
DGOOfftake	A14	Out	By Area	DGO Network EAN code	
DGOInjectionTotal	A14	In	By Area	ALL DGO EIC code: 22YBE-ALLDSO---0	Grouped
DGOOfftakeTotal	A14	Out	By Area	ALL DGO EIC code: 22YBE-ALLDSO---0	
OffshoreInterconnectionInjectionTotal	A14	In	By Area	ALL OIP EIC code: 22YBE-ALLOIP---F	Grouped
OffshoreInterconnectionOfftakeTotal	A14	Out	By Area	ALL OIP EIC code: 22YBE-ALLOIP---F	
TSOInjectionTotal	A14	In	By Area	Total on the Elia network: 22YBE-TSO-----9	Grouped
TSOOfftakeTotal	A14	Out	By Area	Total on the Elia network: 22YBE-TSO-----9	
CDSLosesTotal	A15	Out	By Area	ALL CDS EIC code: 22YBE-ALLCDS---3	
DGOLosesTotal	A15	Out	By Area	ALL DGO EIC code: 22YBE-ALLDSO---0	
TSOLosesTotal	A15	Out	By Area	Total on the Elia network: 22YBE-TSO-----9	
ImbalanceRecipient	A20	In	By party	BRP EIC code	
ImbalanceRecipient	A20	In	By party	HUB BRP EIC code	
OtherDownCorrTotal	A23	In	By party	BRP EIC code	Grouped
OtherUpCorrTotal	A23	Out	By party	BRP EIC code	
ImbalanceResultofthePooling	B32	In	By party	BRP EIC code	

Component	Business Type	Flow direction	Aggregation	Party/area	XML Grouping
CDSLoopLosses	Z01	Out	By Area	CDS Network EAN code	
CDSLoopLossesTotal	Z01	Out	By Area	ALL CDS EIC code: 22YBE-ALLCDS---3	
DGOLoopLosses	Z01	Out	By Area	DGO Network EAN code	
DGOLoopLossesTotal	Z01	Out	By Area	ALL DGO EIC code: 22YBE-ALLDSO---0	
mFRRDPpg&DA/IDDownBrpbspCorr	Z20	In	By Party	BRP EIC code	Grouped
mFRRDPpg&DA/IDUpBrpbspCorr	Z20	Out	By Party	BRP EIC code	
mFRRDPpg&DA/IDBrpBspCorrTotal	Z22	In	By Party	BRP EIC code	
aFRRUpCorrTotal	Z27	Out	By Party	BRP EIC code	
aFRRDownCorrTotal	Z27	In	By Party	BRP EIC code	
mFRRDPpg&DA/IDBrpSourceCorrTotal	Z30	In	By Party	BRP EIC code	
mFRRDPpg&DA/IDTotal	Z31	In	By Party	BRP EIC code	
mFRRDPsuUpCorr Total	Z37	Out	By Party	BRP EIC code	
mFRRDPsuDownCorr Total	Z37	In	By Party	BRP EIC code	
RedispatchingUpCorr Total	Z38	Out	By Party	BRP EIC code	
RedispatchingDownCorr Total	Z38	In	By Party	BRP EIC code	

Table 32 XML Time Series Imbalance component and related data

2.7.7.2. XML Imbalance Period fields

The <Period> element contains information to characterize the power value and quality for a period. It contains also the Period element: see

```
<Period>
<timeInterval>
<start>2015-07-31T22:00Z</start>
<end>2015-08-30T22:00Z</end>
</timeInterval>
<resolution>PT15M</resolution>
<Point>
```

All elements are mandatory and listed in the table below.

Element name	Content type	Description
period.timeInterval	Start / End: Date	Covered Period: Normally this is exactly one month in ISO 8601 format (see section "3.2 XML elements
resolution	String	Total number of minutes in the schedule. (! See also section 4.5, on the effect of daylight saving.)
Point	See below	

Table 33 XML period components and related data

2.7.7.3. XML Imbalance Point fields

The <Point> element contains information to characterize the power value and quality for a period

```
<Point>
<position>2</position>
<in_Quantity.quantity>113423.485</in_Quantity.quantity>
<in_Quantity.quality>A04</in_Quantity.quality>
<out_Quantity.quantity>542630.839</out_Quantity.quantity>
<out_Quantity.quality>A04</out_Quantity.quality>
</Point>
```

All elements are mandatory and listed in the table below.

Element name	Cardinality	Content type	Description
position	Mandatory	Integer [1...2884]	The position of the quarter within the covered period
in_Quantity.quantity	Optional	Double	Value for the direction IN (if possible for the component) or the element is not present
in_Quantity.quality	Optional	Element	Quality for the direction IN (if possible for the component) or the element is not present Possible values: <ul style="list-style-type: none"> • Normal : "A04" • Inexact: "A02" • Substituted: "A01"
out_Quantity.quantity	Optional	Double	Value for the direction OUT (if possible for the component) or the element is not present
out_Quantity.quality	Optional	Element	Quality for the direction OUT (if possible for the component) or the element is not present Possible values: <ul style="list-style-type: none"> • Normal : "A04" • Inexact: "A02" • Substituted: "A01"

Table 34 XML <point> element for Imbalance messages



2.7.8. Excel Imbalance Value

The Excel file contains one sheet named "000000000000000000": This sheet contains all information about each imbalance component and related criteria's for a given month:

- The top rows contain information about the receiver, the status of the message and the time of creation (last update) of the message and the fact that this sheet follow the Imbalance message format
- Subsequent area of the sheet is divided into columns
- The first lines of the columns give information about the component name, Direction (Power Flow), Party or Area) described in "2.7.8.1 Header"
- The quarter hourly values give the power value and the quality for the mentioned metering data.
- Elia does not guarantee the order of components within the message.

	A	B	C	D	E	F	G	H	I
1	Company	22XBRPB-----0		BRP test					
2	Last Update	14-08-2020		Imbalance					
3	Status	Final							
4	Version	1							
5									
6		Component		CrossBorderExportTotal		DGOInjection		DGOInjection	
7		Direction		Outgoing		Incoming		Incoming	
8		Description		BRP test		Infrax West (541453199767702817)		RESA (541453199449664358)	
9				Value	Quality	Value	Quality	Value	Quality
10		Monthly energy		1,962,781 KWh	Valid	536,469 KWh	Valid	197,241 KWh	Valid
11									
12		Quarter hourly values							
13		Date	From To	W		W		W	

Example 25 Excel Imbalance message sheet

The Imbalance metering message consists of the following sections:

- A header
- A set of columns headers
- A set of columns values

2.7.8.1. Header

The header contains reference of the BRP and the state, version.

	A	B	C	D
1	Company	22XBRPB-----0		BRP test
2	Last Update	14-08-2020		Imbalance
3	Status	Final		
4	Version	1		

Figure 10 Excel Imbalance message –header

Excel Cell	Name	Data type	Comment
B1:C1 (merged cells)	Receiver identification code	String	EIC company code of the receiver of the message.
D1:F1 (merged cells)	Receiver name	String	Name of the company receiver of the message. Note this is a “display name” that can be different from the official name of the company
B2:C2 (merged cells)	Message status	Date and time	Date and time of the creation of the highest version of this document.
D2:F2 (merged cells)	Message type	String	Fixed. Always “Imbalance”
B3:C3 (merged cells)	Last update date	String	State of the message. Possible values: -Intermediate -Final -Final Modified
B4:C4 (merged cells)	version	Integer [1..999]	The version of the message: An integer within range [1...999]. Note: The first message sent is not guaranteed to have version 1.

Table 35 Excel Access Point header fields

2.7.8.2. Columns header

From the 4th column, a set of 2 columns identifies the source of each metering data for one component. An Excel sheet can contain many sets of columns. For one column (example Column 4 and 5):

	A	B	C	D	E
6	Component			CrossBorderExportTotal	
7	Direction			Outgoing	
8	Description			BRP test	
9				Value	Quality
10	Monthly energy			0 KWh	Valid
11	Quarter hourly values				
12	Date	From	To	W	

Figure 11 Excel Imbalance message –columns header

Line	Name	Data type	Comment
6	Component	String	One of the possible components. See "2.7.1 Imbalance Components"
7	Direction	String	Identification of the direction of flow (see section see "2.7.2 Imbalance components "). Possible values are: <ul style="list-style-type: none"> Outgoing (OUT): the energy is going out the BRP Balance perimeter Incoming (IN): the energy is coming in the BRP balance perimeter
8	Party or Area	String	The Party or Area related to the component: see "2.7.3 Imbalance components added parameters"
10	Sum of the monthly energy		Excel formula = the sum of all quarter hourly values and related unit
11	Power unit	String	Unit in which the power values are defined. Possible values are: - W

Table 36 Excel Imbalance column metering reference

2.7.8.3. Columns values

The same columns (starting from the 4th column), contain the metering values and their quality (on the next column) All the quarter hourly values of the month are present:

Column	Name	Data type	Comment
4, 6, 8, 10, 12, etc.	Value	Signed Decimal	Value of the transferred power for the given quarter. The value is expressed in the defined unit and contains a maximum of 3 digits after the decimal point. In case of negative value the sign '-' is added
5, 7, 9, 11, 13, etc.	Quality	1 char	Indication as to the quality of the metered data for the given quarter (see Metering Manual Concepts). Possible values are: <ul style="list-style-type: none"> • N: Normal • I: Inexact • S: Substituted (Estimated replacement).

Table 37 Excel Imbalance [schedule] fields

2.8. Transfer of Energy (ToE) Delivered volumes

The Transfer of Energy (ToE) Delivered volumes messages provide the volumes of energy delivered by DP_{PG} delivery points (former non CIPU) , falling under a ToE regime, in the framework of the mFRR & DA/ID service.

These messages contain the data for one calendar month. The structure of the message identifies the BSP/FSP(s), Transfer of Energy (ToE), the time period, all the parameters used to describe the power values and the actual power values. This message content can be delivered in one of three formats; CSV format described in section 2.8.2, XML format described in section 2.8.3 and XLSX format described in section 2.8.4

2.8.1. Transfer of Energy (ToE) delivered volumes Components

The Transfer of Energy (ToE) delivered volumes message gives the Transfer of Energy (ToE) using following facets:

- Delivery direction: Up or Down
- Metering direction: Offtake or Injection
- Detail: Per Delivery Point or total

In detail, following components are available:

Component	Description
TotalToEVolumesUpInjection_DeliveredVolume_PerDeliveryDirection&MeteringDirection	Total volume delivered in the upward direction by the BSP/FSP with the injection counterpart of the delivery points DP _{PG} falling under a ToE regime in the framework of the mFRR & DA/ID services (according to the ToE rules)
TotalToEVolumesDownInjection_DeliveredVolume_Total_PerDelivery&MeteringDirection	Total volume delivered in the downward direction by the BSP/FSP with the injection counterpart of the delivery points DP _{PG} falling under a ToE regime in the framework of the mFRR & DA/ID services (according to the ToE rules)
TotalToEVolumesUpOfftake_DeliveredVolume_PerDelivery&MeteringDirection	Total volume delivered in the upward direction by the BSP/FSP with the offtake counterpart of the delivery points DP _{PG} falling under a ToE regime in the framework of the mFRR & DA/ID services (according to the ToE rules)
TotalToEVolumesDownOfftake_DeliveredVolume_PerDeliveryDirection&MeteringDirection	Total volume delivered in the downward direction by the BSP/FSP with the offtake counterpart of the delivery points DP _{PG} falling under a ToE regime in the framework of the mFRR & DA/ID services (according to the ToE rules)
ToEVolumesUpInjection_DeliveredVolumeperDeliveryPoint_PerDelivery&MeteringDirection	Volume by delivery point delivered in the upward direction by the BSP/FSP with the injection counterpart of the delivery points DP _{PG} falling under a ToE regime in the framework of the mFRR & DA/ID services (according to the ToE rules)
ToEVolumesDownInjection_DeliveredVolumeperDeliveryPoint_PerDelivery&MeteringDirection	Volume by delivery point delivered in the downward direction by the BSP/FSP with the injection counterpart of the delivery points DP _{PG} falling under a ToE regime in the framework of the mFRR & DA/ID services (according to the ToE rules)
ToEVolumesUpOfftake_DeliveredVolumeperDeliveryPoint_PerDelivery&MeteringDirection	Volume by delivery point delivered in the upward direction by the BSP/FSP with the offtake counterpart of the delivery points DP _{PG} falling under a ToE regime in the framework of the mFRR & DA/ID services (according to the ToE rules)
ToEVolumesDownOfftake_DeliveredVolumeperDeliveryPoint_PerDelivery&MeteringDirection	Volume by delivery point delivered in the downward direction by the BSP/FSP with the offtake counterpart of the delivery points DP _{PG} falling under a ToE regime in the framework of the mFRR & DA/ID services (according to the ToE rules)

2.8.2. CSV Transfer of Energy (ToE) delivered volumes Value

Transfer of Energy (ToE) delivered volumes messages contain a [header] row, a [data] row describing the component and [schedule] sections. An example of a CSV Transfer of Energy (ToE) delivered volumes message is shown below:

```
[header];10X1001A1001A094;22X2example----4;2021-08-11T15:02:36Z;DPBSP;3;Final;10YBE-----2
[data];ToEVolumesDownInjection_DeliveredVolumeperDeliveryPoint_PerDelivery&MeteringDirection;5
41449200000555507;IN
[schedule];2021-04-29T22:00:00Z;1440;15;A;N;C;ULP;KW;695939;N;469[end]
```

Example 26 CSV Transfer of Energy (ToE) delivered volumes message

The Imbalance Message consists of the following sections:

- a [header] section
- [data] sections
- [schedule] sections
- [end] – which is the last line indicating the end of the message. All characters following [end] must be ignored.

2.8.2.1. [header]

The [header] row contains information about the sender and the receiver of the message as well as the time of creation, the version number, state of the message and the fact that this is an Imbalance message. There is only one [header] row in the message.

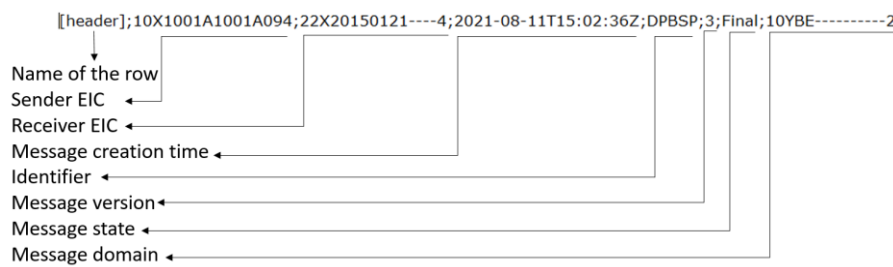

Field	Name	Data type	Comment
1	Name of the row	String	Fixed. Always [header]
2	Sender identification code	String	EIC code (Energy Identification Code) of the TSO (Elia): 10X1001A1001A094
3	Receiver identification code	String	EIC code (Energy Identification Code) of the BSP/FSP receiver of the message
4	Message creation time	Date	Date and time of the file creation in Iso format
5	Message type	String	Fixed. Always DPBSP
6	Version	String	The version of the message: An integer within range [1...999]. Note: The first message sent is not guaranteed to have version 1.
7	Message status	String	Indicate if the message is 'Intermediate', 'Final' or 'FinalModified'

Table 38 CSV Transfer of Energy (ToE) Delivered volumes [header] fields

2.8.2.2. [data]

A [data] row contains information about the component and related criteria's. A [data] section is always followed by at least one [schedule] section. There are several [data] sections that correspond to different components.

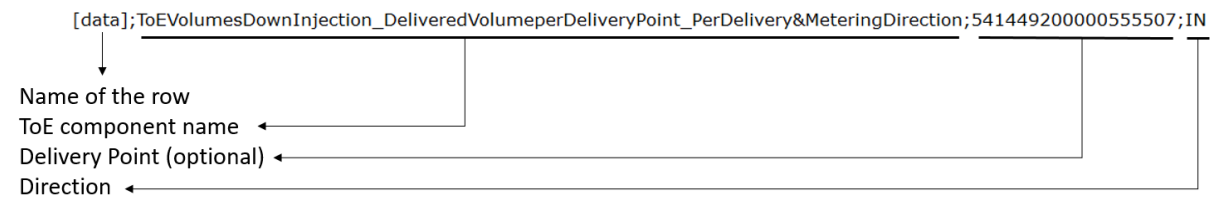

Field	Name	Data type	Comment
1	Name of the row	String	Fixed. Always [data]
2	Component	String	Name of the component: See "2.7.1 Imbalance Components"
3	Party/Area	String	The party or Area related to the component: see Section 2.7.3 "Imbalance components added parameters"
3	Direction of Power flow	String	Identification of the direction of flow (see section see "2.7.2 Imbalance components"). Possible values are: <ul style="list-style-type: none"> • OUT: the energy is going out the BRP Balance perimeter • IN: the energy is coming in the BRP balance perimeter

Table 39 CSV Transfer of Energy (ToE) Delivered volumes message [data] fields

2.8.2.2.1. [schedule]

A [schedule] section contains the power values transferred over the specified time period and identifies the type of power. The Time period constitutes 1 day of 23, 24 or 25 hours. For any component identified in the [data] section, there can be a number of schedules. The fields contained in the [schedule] are listed below; the general meaning of these fields can be found in The Metering Manual Concepts.

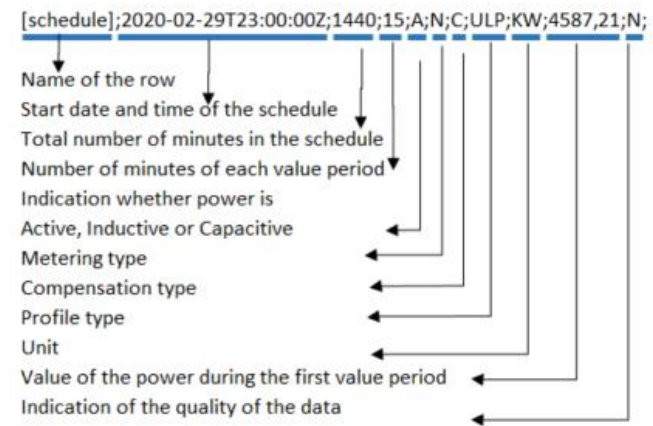

Field	Name	Data type	Comment
1	Name of the row	String	Fixed. Always [schedule]
2	Start date and time	Date	Start date and time of the schedule in ISO 8601 format
3	Duration	Integer	Total number of minutes in the schedule.
4	Period	Integer	Number of minutes for each value period. Always 15.
5	Power type	String	Identification of the type of power* (see Metering Manual Concept). Possible values are: <ul style="list-style-type: none"> • A: Active • I: Inductive • C: Capacitive * Normally only Active power type are part of the Imbalance message but theoretically other power type could also exist
6	Metering type	String	Indication as to whether the values are net or gross* or specific (see Metering Manual Concept). Possible values are <ul style="list-style-type: none"> • N: Net • G: Gross • GG: "Green Gross" * Normally only Net metering type are part of the Imbalance message but theoretically other metering type could also exist
7	Compensation type	String	Indication as to whether the values are compensated or not* (see Metering Manual Concepts). Possible values are: <ul style="list-style-type: none"> • NC: Non-Compensated. Used for metering purposes.

			<ul style="list-style-type: none"> • C: Compensated. Used for billing purposes • A: Reserved for future use • CC: Compensated Corrected Used for specific purposes <p>* Normally only Compensated are part of the Imbalance message but theoretically other Compensation type could also exist</p>
8	Profile type	String	<p>Indication of the load profile*. This field is reserved for probable future use and has no significant meaning. Currently, values could be:</p> <ul style="list-style-type: none"> • ALP: Aggregated load profile • ULP: Undefined load profile <p>* Normally only ULP are part of the Transfer of Energy (ToE) delivered volumes message but theoretically ULP type could also exist</p>
9	Unit	String	<p>Unit in which the metered values are defined. Normally always KW</p>
10 to 202 in steps of 2	Value	Signed Decimal	<p>Value of the metered quantity in the unit defined in Field 9 above with a maximum of 3 digits after the decimal point.</p> <ul style="list-style-type: none"> • If the value is positive then no "+" sign is added • If the value is negative then "-" sign is added
11 to 203 in steps of 2	Quality	1 char	<p>Indication as to the quality of the metered data (see Metering Manual Concepts). Possible values are:</p> <ul style="list-style-type: none"> • N: Normal • I: Inexact • S: Substituted (Estimated replacement).

Table 40 CSV Transfer of Energy (ToE) delivered volumes message [schedule] fields

2.8.3. XML Transfer of Energy (ToE) delivered volumes value

The XML Transfer of Energy (ToE) delivered volumes message respects the **IEC standard 62325-451-4**. The structure therefore is briefly explained in this document but whole description is available on the IEC web store: <https://webstore.iec.ch/publication/29116>.

The Reference XML Schema (XSD) address can be found in section "3.1 Reference XSD " p 116

```
<EnergyAccount_MarketDocument xsi:schemaLocation="urn:iec62325.351:tc57wg16:451-4:energyaccountdocument:4:0 iec62325-451-4-settlement_v4.xsd"
xmlns="urn:iec62325.351:tc57wg16:451-4:energyaccountdocument:4:0"
xmlns:xsi="http://www.w3.org/2001/XMLSchema-instance">
</EnergyAccount_MarketDocument>
```

Example 27 XML Transfer of Energy (ToE) delivered volumes message root

The message begins with information about the sender of the message (Elia) and the receiver as well as the time when the message was created plus some information about the state of this message: This header is valid for all the Time Series.

Remark: the XML comments indicated in the message here below are for the reader comprehension and are available in the message sent by Elia;

```
<EnergyAccount_MarketDocument xsi:schemaLocation="urn:iec62325.351:tc57wg16:451-4:energyaccountdocument:4:0 iec62325-451-4-settlement.xsd"
xmlns="urn:iec62325.351:tc57wg16:451-4:energyaccountdocument:4:0"
xmlns:xsi="http://www.w3.org/2001/XMLSchema-instance">
  <mRID>DPBSP_20200101_20200131</mRID>
  <revisionNumber>1</revisionNumber>
  <type>Z05</type>
  <docStatus>
    <value>A01</value>
  </docStatus>
  <process.processType>Z03</process.processType>
  <process.classificationType>A01</process.classificationType>
  <sender_MarketParticipant.mRID
codingScheme="A01">10X1001A1001A094</sender_MarketParticipant.mRID>
  <sender_MarketParticipant.marketRole.type>
    A04</sender_MarketParticipant.marketRole.type>
  <receiver_MarketParticipant.mRID codingScheme="A01">22X20131122----
9</receiver_MarketParticipant.mRID>
  <receiver_MarketParticipant.marketRole.type>
    R12</receiver_MarketParticipant.marketRole.type>
  <createdDateTime>2020-12-29T17:49:12Z</createdDateTime>
  <period.timeInterval>
    <start>2020-07-31T22:00Z</start>
    <end>2020-08-31T22:00Z</end>
  </period.timeInterval>
  <domain.mRID codingScheme="A01">10YBE-----2</domain.mRID>
```

Example 28 XML Transfer of Energy (ToE) delivered volumes) message header

2.8.3.1.1. XML Transfer of Energy (ToE) delivered volumes Header fields

The following header fields are mandatory and are listed in the table below.

Element name	Content type	Description
mRID	String [1..35]	The unique identification of the document. Any implementation should only refer to this mRID to determine if this message instance was already treated or not.
revisionNumber	Integer [1...999]	The version number of the document: It is not guaranteed that first document received by the BRP has version number 1. A more recent document has a higher version number
type	String [3]	Fixed. Always Z05 (DP to BSP)
docStatus	String [3]	The status of the Imbalance document. Possible values: <ul style="list-style-type: none"> • A01 - Intermediate • A02 - Final • A03 - Final Modified
process.processType	String [3]	<ul style="list-style-type: none"> • Fixed. Always Z03
process.classificationType	String [3]	The classification mechanism used to group a set of objects together within a business process. Possible values: <ul style="list-style-type: none"> • A01 - Detail • A02 - Summary Normally only A01 is part of the Imbalance message but theoretically other classificationType could also exist
sender_MarketParticipant.mRID	codingScheme: String [3] Value: String [16]	Fixed: <ul style="list-style-type: none"> • codingScheme: A01 (EIC) • 10X1001A1001A094 (Elia EIC)
sender_MarketParticipant.marketRole.type	String [3]	Fixed: Always A04 (System operator)
receiver_MarketParticipant.mRID	codingScheme: String [3] Value: String [16]	<ul style="list-style-type: none"> • codingScheme: Fixed A01 (EIC) • Value : EIC code of the BSP
receiver_MarketParticipant.marketRole.type	String [3]	Fixed: Always R12 (BSP)
createdDateTime	Date and time	Time at which the message was created (in UTC time).
period.timeInterval	Start / End: Date	Covered Period: Normally this is exactly one month (in UTC time). Example for the month August 2015: Start time is 31/7/2015 at 22h. End time is 31/8/2015 at 22h Any period is theoretically possible.

Domain.mRID	codingScheme: String [3] Value: String [16]	Fixed: Always <ul style="list-style-type: none">codingScheme: A01 (EIC)10YBE-----2 (Belgian Area)
-------------	--	--

Table 41 XML header elements for Transfer of Energy (ToE) delivered volumes messages

2.8.3.1.1. XML Transfer of Energy (ToE) delivered volumes TimeSeries fields

The <TimeSeries> element describes the flow of the power for one component and related criteria and the schedule of actual power values.

Elia does not guarantee the order of Timeseries within the message.

```
<TimeSeries>
  <mRID>Z17_541448911000004100</mRID>
  <businessType>Z17</businessType>
  <product>8716867000030</product>
  <MeteringType>A01</MeteringType>
  <CalculationMethod>A01</CalculationMethod>
  <objectAggregation>A01</objectAggregation>
  <area_Domain.mRID codingScheme="A10">541448911000004100</area_Domain.mRID>
  <measure_Unit.name>KWT</measure_Unit.name>
  <Period>...</Period>
</TimeSeries>
```

Example 29 XML Transfer of Energy (ToE) delivered volumes message TimeSeries

The general meaning of these fields is given in The Metering Manual Concept. All elements are listed in the table below.

Element name	Content type	Description
mRID	String [1..35]	Time series unique identification within the message
businessType	String [3]	Fields identifying the characteristics of the component : See table below
product	String [1..35]	Fixed. Always 8716867000016 - Active Power
objectAggregation	String [3]	Based on the business type. See table here below
area_Domain.mRID	String [1..18]	Based on the business type. See table here below
marketParticipant.mRID	String [1..18]	Based on the table here below, is the EIC code of the Party
measure_Unit.name	String [3]	Power unit. Always KWT
Period	See Section 2.7.7.2 "XML Imbalance Period Fields"	

Table 42 XML Time Series element for Transfer of Energy (ToE) delivered volumes messages

Component	Business Type	Flow direction	Aggregation	Party/area	Market Participant	XML Grouping
TotalToEVolumesUpInjection_DeliveredVolume_PerDeliveryDirection&MeteringDirection	Z33	In	By Party	10YBE-----2	BSP/FSP EIC	Grouped
TotalToEVolumesUpOfftake_DeliveredVolume_PerDelivery&MeteringDirection	Z33	Out	By Party	10YBE-----2	BSP/FSP EIC	
TotalToEVolumesDownInjection_DeliveredVolume_Total_PerDelivery&MeteringDirection	Z34	In	By Party	10YBE-----2	BSP/FSP EIC	Grouped
TotalToEVolumesDownOfftake_DeliveredVolume_PerDeliveryDirection&MeteringDirection	Z34	Out	By Party	10YBE-----2	BSP/FSP EIC	
ToEVolumesUpInjection_DeliveredVolumeperDeliveryPoint_PerDelivery&MeteringDirection	Z35	In	By Area	Delivery Point EAN	Not used	Grouped
ToEVolumesUpOfftake_DeliveredVolumeperDeliveryPoint_PerDelivery&MeteringDirection	Z35	Out	By Area	Delivery Point EAN	Not used	
ToEVolumesDownInjection_DeliveredVolumeperDeliveryPoint_PerDelivery&MeteringDirection	Z36	In	By Area	Delivery Point EAN	Not used	Grouped
ToEVolumesDownOfftake_DeliveredVolumeperDeliveryPoint_PerDelivery&MeteringDirection	Z36	Out	By Area	Delivery Point EAN	Not used	

Table 43 XML Time Series Business ID element possible values and related data for Transfer of Energy (ToE) delivered volumes message

2.8.3.1.2. XML Transfer of Energy (ToE) delivered volumes Period fields

The <Period> element contains information to characterize the power value and quality for a period. It contains also the Period element: see

```
<Period>
<timeInterval>
<start>2015-07-31T22:00Z</start>
<end>2015-08-30T22:00Z</end>
</timeInterval>
<resolution>PT15M</resolution>
<Point>
```

All elements are mandatory and listed in the table below.

Element name	Content type	Description
period.timeInterval	Start / End: Date	Covered Period: Normally this is exactly one month in ISO 8601 format (see section "3.2 XML elements")
resolution	String	Total number of minutes in the schedule. (! See also section 4.5, on the effect of daylight saving.)
Point	See below	

Table 44 XML Time Series period and related data for Transfer of Energy (ToE) delivered volumes message

2.8.3.1.3. XML Transfer of Energy (ToE) delivered volumes Point fields

The <Point> element contains information to characterize the power value and quality for a period

```
<Point>
<position>2</position>
<in_Quantity.quantity>113423.485</in_Quantity.quantity>
<in_Quantity.quality>A04</in_Quantity.quality>
<out_Quantity.quantity>542630.839</out_Quantity.quantity>
<out_Quantity.quality>A04</out_Quantity.quality>
</Point>
```

All elements are listed in the table below.

Element name	Cardinality	Content type	Description
position	Mandatory	Integer [1...2884]	The position of the quarter within the covered period
in_Quantity.quantity	Optional	Double	Value for the direction IN (if possible for the component) or the element is not present
in_Quantity.quality	Optional	Element	Quality for the direction IN (if possible for the component) or the element is not present Possible values: <ul style="list-style-type: none"> • Normal : "A04" • Inexact: "A02" • Substituted: "A01"
out_Quantity.quantity	Optional	Double	Value for the direction OUT (if possible for the component) or the element is not present
out_Quantity.quality	Optional	Element	Quality for the direction OUT (if possible for the component) or the element is not present Possible values: <ul style="list-style-type: none"> • Normal : "A04" • Inexact: "A02" • Substituted: "A01"

Table 45 XML <point> element for Transfer of Energy (ToE) delivered volumes messages



2.8.4. Excel Transfer of Energy (ToE) delivered volumes value

The Excel file contains two sheets named "Summary" and "Detail": These sheets contain all information about all components and related criteria's for a given month:

- The top rows contain information about the receiver, the status of the message and the time of creation (last update) of the message and the fact that this sheet follow the Imbalance message format
- Subsequent area of the sheet is divided into columns
- The first lines of the columns give information about the component name, Direction (Power Flow), Party or Area)
- The quarter hourly values give the power value and the quality for the mentioned metering data.
- Elia does not guarantee the order of components within the message.

	A	B	C	D	E	F	G	H	I	J	K
1	Company	22XDPBSPEXAMPLE		BSPEXAMPLE							
2	Last Update	11-08-2021									
3	Status	Final		DPBSP							
4	Version	3									
5											
6	Component			TotalToEVolumesUpInj		TotalToEVolumesUpOfftake		TotalToEVolumesDownInj		TotalToEVolumesDownOfftake	
7				DeliveredVolume		DeliveredVolume		DeliveredVolume		DeliveredVolume	
8	Party			BSPEXAMPLE		BSPEXAMPLE		BSPEXAMPLE		BSPEXAMPLE	
9				22XDPBSPEXAMPLE		22XDPBSPEXAMPLE		22XDPBSPEXAMPLE		22XDPBSPEXAMPLE	
10	Meterable type			Incoming Active Net Compensated		Outgoing Active Net Compensated		Incoming Active Net Compensated		Outgoing Active Net Compensated	
11				Value Quality		Value Quality		Value Quality		Value Quality	
12	Monthly energy			0 KWh Valid		188 KWh Valid		0 KWh Valid		0 KWh Valid	
13	Quarter hourly values			W		W		W		W	
14	Date	From	To								
15	01-04-2021	00:00	00:15	0	N	0	N	0	N	0	N
16	01-04-2021	00:15	00:30	0	N	0	N	0	N	0	N
17	01-04-2021	00:30	00:45	0	N	0	N	0	N	0	N
18	01-04-2021	00:45	01:00	0	N	0	N	0	N	0	N
19	01-04-2021	01:00	01:15	0	N	0	N	0	N	0	N
20	01-04-2021	01:15	01:30	0	N	0	N	0	N	0	N
21	01-04-2021	01:30	01:45	0	N	0	N	0	N	0	N
22	01-04-2021	01:45	02:00	0	N	0	N	0	N	0	N
23	01-04-2021	02:00	02:15	0	N	0	N	0	N	0	N
24	01-04-2021	02:15	02:30	0	N	0	N	0	N	0	N
25	01-04-2021	02:30	02:45	0	N	0	N	0	N	0	N

Example 30 Excel Transfer of Energy (ToE) delivered volumes message 'Detail' sheet

The Excel file is made of 2 sheets:

- The first sheet, named "Summary", contains the 'Total' components.
- The second sheet, named "Detail", contains the volumes per Delivery Point for the Bid directions Up and Down and metering directions injection and offtake.

The header is the same for all sheets.

2.8.4.1. Transfer of Energy (ToE) delivered volumes - "Summary" header

The header contains reference of the BSP/FSP and the state, version.

	A	B	C	D	E
1	Company	22XBSP--EXAMPLEZ		BSPEXample	
2	Last Update	29-12-2020			
3	Status	Intermediate		DPBSP	
4	Version	1			

Figure 12 Transfer of Energy (ToE) delivered volumes - Excel sheet 'Summary' -header

Excel Cell	Name	Data type	Comment
B1:C1 (merged cells)	Receiver identification code	String	EIC of the BSP/FSP receiver of the message.
D1:F1 (merged cells)	Receiver name	String	Name of the BSP/FSP receiver of the message Note this is a "display name" that can be different from the official name of the company
B2:C2 (merged cells)	Last update date	Date and time	Date and time of the creation of the highest version of this document.
B3:C3 (merged cells)	Message status	String	Indicate if the message is 'Intermediate', 'Final' or 'FinalModified'
D3:F3 (merged cells)	Message type	String	Fixed. Always "DPBSP"
B4 (merged cells)	version	Integer [1..999]	The version of the message: An integer within range [1...999]. Note: The first message sent is not guaranteed to have version 1.

Table 46 Excel 'Transfer of Energy (ToE) delivered volumes 'header fields



2.8.4.2. Transfer of Energy (ToE) delivered volumes - "Summary" Columns header

From the 4th column, a set of 2 columns identifies the source of each metering data for a 'Transfer of Energy (ToE) delivered volumes' component.

This sheet can contain many sets of columns.

	A	B	C	D	E	F	G	H	I	J	K
1	Company	22XDPBSPEXample		BSPEXample							
2	Last Update	11-08-2021									
3	Status	Final		DPBSP							
4	Version	3									
5											
6	Component			TotalToEVolumesUpInjection	TotalToEVolumesUpOfftake		TotalToEVolumesDownInjection		TotalToEVolumesDownOfftake		
7				DeliveredVolume	DeliveredVolume		DeliveredVolume		DeliveredVolume		
8				BSPEXample	BSPEXample		BSPEXample		BSPEXample		
9	Party										
10											
11	Meterable type			Incoming Active Net Compensated		Outgoing Active Net Compensated		Incoming Active Net Compensated		Outgoing Active Net Compensated	
12											
13											
14											
15											
16				Value	Quality	Value	Quality	Value	Quality	Value	Quality
17	Monthly energy			0 KWh	Valid	188 KWh	Valid	0 KWh	Valid	0 KWh	Valid
18											
19	Quarter hourly values										
20	Date	From	To	W		W		W		W	
21	01-04-2021	00:00	00:15	0	N	0	N	0	N	0	N
22	01-04-2021	00:15	00:30	0	N	0	N	0	N	0	N
23	01-04-2021	00:30	00:45	0	N	0	N	0	N	0	N
24	01-04-2021	00:45	01:00	0	N	0	N	0	N	0	N
25	01-04-2021	01:00	01:15	0	N	0	N	0	N	0	N
26	01-04-2021	01:15	01:30	0	N	0	N	0	N	0	N
27	01-04-2021	01:30	01:45	0	N	0	N	0	N	0	N
28	01-04-2021	01:45	02:00	0	N	0	N	0	N	0	N
29	01-04-2021	02:00	02:15	0	N	0	N	0	N	0	N
30	01-04-2021	02:15	02:30	0	N	0	N	0	N	0	N
31	01-04-2021	02:30	02:45	0	N	0	N	0	N	0	N

Figure 13 Excel 'Transfer of Energy (ToE) delivered volumes' message - Sheet 'Summary' - columns header

For one set of columns:

Line	Name	Data type	Comment
6	Component	String	See table below
7	N/A	String	Name of the BSP/FSP
8	N/A	String	EIC of the BSP/FSP
11	Meterable type	String	Metering direction
12	N/A	String	Identification of the power type Fixed. Always "Active"
13	N/A	String	Fixed. Always "Net"
14	N/A	String	Fixed. Always "Compensated"
17	monthly energy	String	Excel formula = the sum of all quarter hourly values and related unit
20	Power unit	String	Unit in which the power values are defined. Fixed. Always W

Table 47 Excel 'Transfer of Energy (ToE) delivered volumes' message – Sheet 'Summary' – columns references

Component	Delivery Direction	Metering Direction
TotalToEVolumesUpInjection_DeliveredVolume_PerDeliveryDirection&MeteringDirection	Delivery Up	Injection
TotalToEVolumesDownInjection_DeliveredVolume_Total_PerDelivery&MeteringDirection	Delivery Down	Injection
TotalToEVolumesUpOfftake_DeliveredVolume_PerDelivery&MeteringDirection	Delivery Up	Offtake
TotalToEVolumesDownOfftake_DeliveredVolume_PerDeliveryDirection&MeteringDirection	Delivery Down	Offtake

Table 48 Excel 'Transfer of Energy (ToE) delivered volumes' message – Sheet 'Summary' – list of components

2.8.4.3. Transfer of Energy (ToE) delivered volumes - "Summary" Columns values

The same columns (starting from the 4th column), contain the metering values and their quality (on the next column) All the quarter hourly values of the month are present.

Column	Name	Data type	Comment
4, 6, 8, 10, 12, etc.	Value	Signed Decimal	Value of the power for the given quarter. The value is expressed in the defined unit and contains a maximum of 3 digits after the decimal point. In case of negative value the sign '-' is added
5, 7, 9, 11, 13, etc.	Quality	1 char	Indication as to the quality of the metered data for the given quarter (see Metering Manual Concept) Possible values are: <ul style="list-style-type: none"> • N: Normal • I: Inexact • S: Substituted (Estimated replacement).

Table 49 Excel 'Transfer of Energy (ToE) delivered volumes)' message – Sheet 'Summary' – Columns values



2.8.4.4. Transfer of Energy (ToE) delivered volumes - "Detail" header

The header content is the same as the one from the 'Summary' sheet. Refer to 2.8.4.1.

2.8.4.5. Transfer of Energy (ToE) delivered volumes - "Detail" Columns header

From the 4th column, a set of 2 columns identifies the source of each metering data for a 'Transfer of Energy (ToE) delivered volumes' component.

This sheet can contain many sets of columns. For one column (example Columns 4 and 5):

	A	B	C	D	E	F	G	H	I	J	K
1	Company	22XDPBSPExample		BSPEXample							
2	Last Update	11-08-2021									
3	Status	Final		DPBSP							
4	Version	3									
5											
6	Component Party			ToEVolumesUpInjecti on		ToEVolumesUpOfftak e		ToEVolumesDownInj ection		ToEVolumesDownOff take	
7				DeliveredVolumeper BSPEXample		DeliveredVolumeper BSPEXample		DeliveredVolumeper BSPEXample		DeliveredVolumeper BSPEXample	
8				5414Example		5414Example		5414Example		5414Example	
9											
10	Meterable type			Incoming Active Net Compensated		Outgoing Active Net Compensated		Incoming Active Net Compensated		Outgoing Active Net Compensated	
11											
12											
13											
14											
15											
16				Value Quality		Value Quality		Value Quality		Value Quality	
17	Monthly energy			0 KWh Valid		63 KWh Valid		0 KWh Valid		0 KWh Valid	
18											
19	Quarter hourly values										
20	Date	From	To	W		W		W		W	
21	01-04-2021	00:00	00:15	0	N	0	N	0	N	0	N
22	01-04-2021	00:15	00:30	0	N	0	N	0	N	0	N
23	01-04-2021	00:30	00:45	0	N	0	N	0	N	0	N
24	01-04-2021	00:45	01:00	0	N	0	N	0	N	0	N
25	01-04-2021	01:00	01:15	0	N	0	N	0	N	0	N
26	01-04-2021	01:15	01:30	0	N	0	N	0	N	0	N
27	01-04-2021	01:30	01:45	0	N	0	N	0	N	0	N
28	01-04-2021	01:45	02:00	0	N	0	N	0	N	0	N
29	01-04-2021	02:00	02:15	0	N	0	N	0	N	0	N
30	01-04-2021	02:15	02:30	0	N	0	N	0	N	0	N
31	01-04-2021	02:30	02:45	0	N	0	N	0	N	0	N

Figure 14 Excel 'Transfer of Energy (ToE) delivered volumes' message – Sheet 'Detail' –columns header

For one set of columns:

Line	Name	Data type	Comment
6	Component	String	See table below
7		String	Name of Delivery Point
8	Domain	String	EAN of Delivery Point
9		EAN	EAN of Border Point (even if the component is an Interconnection Point)
11	Meterable type	String	<p>Identification of the Metering direction(direction of the flow)</p> <p>Possible values are:</p> <ul style="list-style-type: none"> Outgoing (OUT): the energy is going out of this Border Point or Interconnection Point Incoming (IN): the energy is coming in the Border Point or Interconnection Point
12	N/A	String	Identification of the power type. Always : "Active"
13	N/A	String	Fixed. Always "Net"
14	N/A	String	Always "Compensated"
17	monthly energy	String	Excel formula = the sum of all quarter hourly values and related unit
20	Power unit	String	Unit in which the power values are defined. Fixed. Always W

Table 50 Excel 'Transfer of Energy (ToE) delivered volumes' message – Sheet 'Detail' – Columns values

Component	DeliveryDirection	MeteringDirection
ToEVolumesUpInjection_DeliveredVolumeperDeliveryPoint_PerDelivery&MeteringDirection	DeliveryUp	Injection
ToEVolumesDownInjection_DeliveredVolumeperDeliveryPoint_PerDelivery&MeteringDirection	DeliveryDown	Injection
ToEVolumesUpOfftake_DeliveredVolumeperDeliveryPoint_PerDelivery&MeteringDirection	DeliveryUp	Offtake
ToEVolumesDownOfftake_DeliveredVolumeperDeliveryPoint_PerDelivery&MeteringDirection	DeliveryDown	Offtake

Table 51 Excel 'Transfer of Energy (ToE) delivered volumes' message – Sheet 'Detail' – Components

2.8.4.6. Transfer of Energy (ToE) delivered volumes - "Detail" Columns values

The same columns (starting from the 4th column), contain the metering values and their quality (on the next column) All the quarter hourly values of the month are present.

The format of values is the same as on the sheet "Summary". See Section 2.8.4.3.

2.8.4.7. Transfer of Energy (ToE) delivered volumes - "Detail" Columns values

The same columns (starting from the 4th column), contain the metering values and their quality (on the next column) All the quarter hourly values of the month are present.

The format of values is the same as on the sheet "Summary". See Section 2.8.4.3.

2.9. Real-Time DGO Allocation

One of the previous Section 2.7 introduced the imbalance message. Due to current market processes, the DGO Allocation component (DGOInjectionTotal and DGOOfftakeTotal described in section 2.7.1.1), the imbalance message for month M can be sent at earliest by the end of M+1, usually around M+2.

Based on machine-learning technique, real-time the DGO Allocation are estimated. The estimation algorithm is based on linear regression and uses a specific, per BRP, combination of variables.

$$RT\ DGO\ Alloc\ Estimate_{BRP_i}(qh) = Intercept_{BRP_i} + \sum_{j=1}^N Coeff_{BRP_i}(j) * Variable_j(qh)$$

Figure 15: Linear regression model for Real-Time DGO Allocation Estimation

The variables are grouped in different families (Infeed, Wind Forecast, Solar Forecast...) each variable providing specific details about an element (Infeed at border point A, Infeed at border point B... Wind Forecast for wind farm x, Wind forecast for wind farm Y...). In total, the regression model can use more than 700 variables. Note that these variables are not sent together with the message.

Given the similarity of the Real-Time DGO Allocation to the Imbalance components DGOInjectionTotal and DGOOfftakeTotal, the Real-Time DGO Allocation message is remarkably similar to an imbalance message. For that reason, the Real-Time DGO Allocation is published as a component of a Real-time Imbalance message (remarkably like the Imbalance message defined in "2.7 Imbalance"). This component is expressed in a single direction (DGONetInjectionEstimateTotal) that can take negative values (in case of net offtake).

Given the fact that this Real-Time DGO Allocation is an estimate made using variables in real-time, it can happen that some of these variables are not available at the moment the estimation must be made. In such circumstances, the estimation algorithm will nevertheless make an estimation, but of less quality than the estimate with all variables.

In order to inform message recipients of such situations, the Real-Time DGO Allocation has a second component, DGONetInjectionEstimateQualityTotal, giving the quality of the estimate in %. A quality of 100% means that all variables required for estimating the Real-Time DGO Allocation were available and used. A quality of less than 100% means that some variables could not be used for making an estimate.

All of the parameters used to describe power values are explained in the Metering Manual Concepts.

Real-Time DGO Allocation messages identify the BRP, the time period, all the parameters used to describe the power values, Real Time DGO Allocation Estimate (kW) and the Real Time DGO Allocation Estimate quality (%).

This message content can be delivered in one of three formats:

- CSV format described in Section 2.9.2.
- XML format described in Section 2.9.3.
- Excel (XLSX) format described in Section 2.9.4.

This message format is remarkably similar to the Imbalance message (see "2.7 Imbalance where the different values for publication are considered as a new imbalance component).

2.9.1. Real-Time DGO Allocation components

The components that can be presented to the BRP are:

Component	Description	XML Business type
DGOAllocationEstimateTotal	The latest calculated value of the real-time estimate in kW	Z22
DGOAllocationEstimateQuality	The quality of the estimation (percentage)	Z23

2.9.2. CSV Real-Time DGO Allocation

Real-Time DGO Allocation messages contain a [header] row, a [data] row, [schedule] sections and an [end] row. An example of a CSV Real-Time DGO Allocation message is shown below.

```
[header];10X1001A1001A094;22XTEST-ARP-ARPA;2019-09-14T22:00:00Z;IMBALANCERT;10;Intermediate
[data];DGOAllocationEstimateTotal;22XTEST-ARP-ARPA;OUT
[schedule];2019-09-13T22:00:00Z;1440;15;A;N;C;ALP;KW;-100,05;N;-110,89;N...
[data];DGOAllocationEstimateQuality;22XTEST-ARP-ARPA;OUT
[schedule];2019-09-13T22:00:00Z;1440;15;A;N;C;ALP;%;100,0;N;90,0;N...
...
[end]
```

Example 31 CSV Real-Time DGO Allocation message

2.9.2.1. [header]

The [header] row is the same as the "Imbalance" message and contains information about the sender and the receiver of the message as well as the time of creation, the version number, state of the message and the fact that this is an Imbalance message. There is only one [header] row in the message.

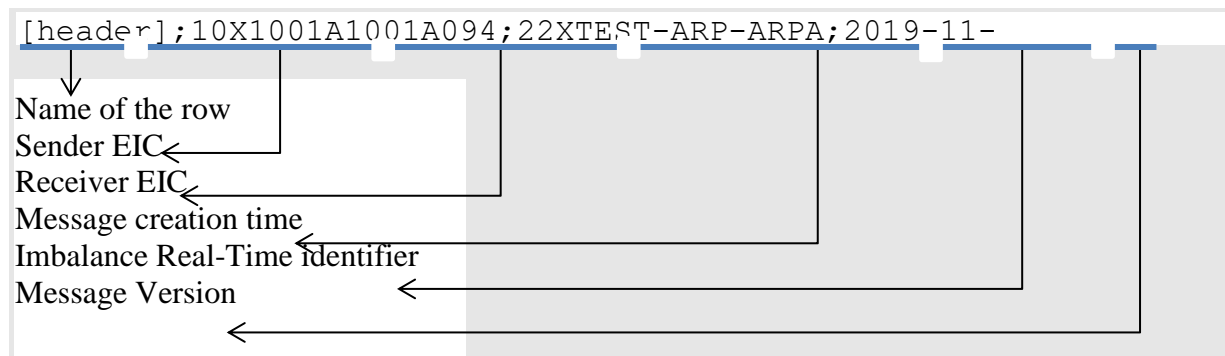



2.9.2.2. [data]

A [data] row contains information about the component and related criteria's. A [data] section is always followed by at least one [schedule] section. There are several [data] sections that correspond to different components.

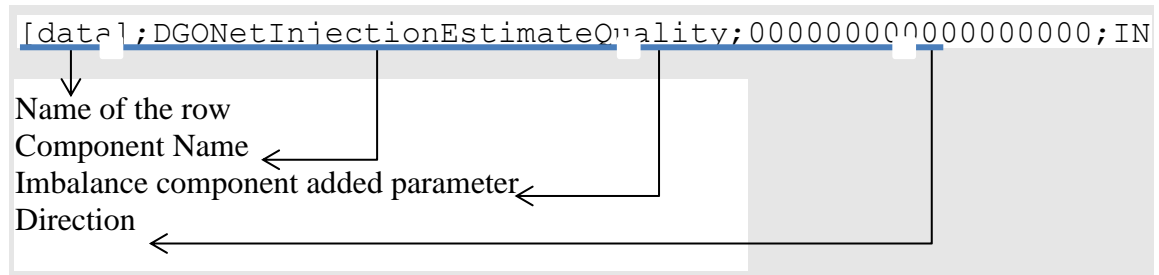

The possible components names for this Real-Time DGO Allocation messages are defined in section "2.9.1



Real-Time DGO Allocation components".

2.9.2.3. [schedule]

A [schedule] section contains the values transferred over the specified time period and identifies the type of value, in the case of Real-Time DGO Estimation it can be either power (KW) or an Estimate Quality (%). The Time period constitutes 1 day of 23, 24 or 25 hours. For any component identified in the [data] section, there can be a number of [schedules]. The fields contained in the [schedule] are listed below; the general meaning of these fields can be found in The Metering Manual Concepts.

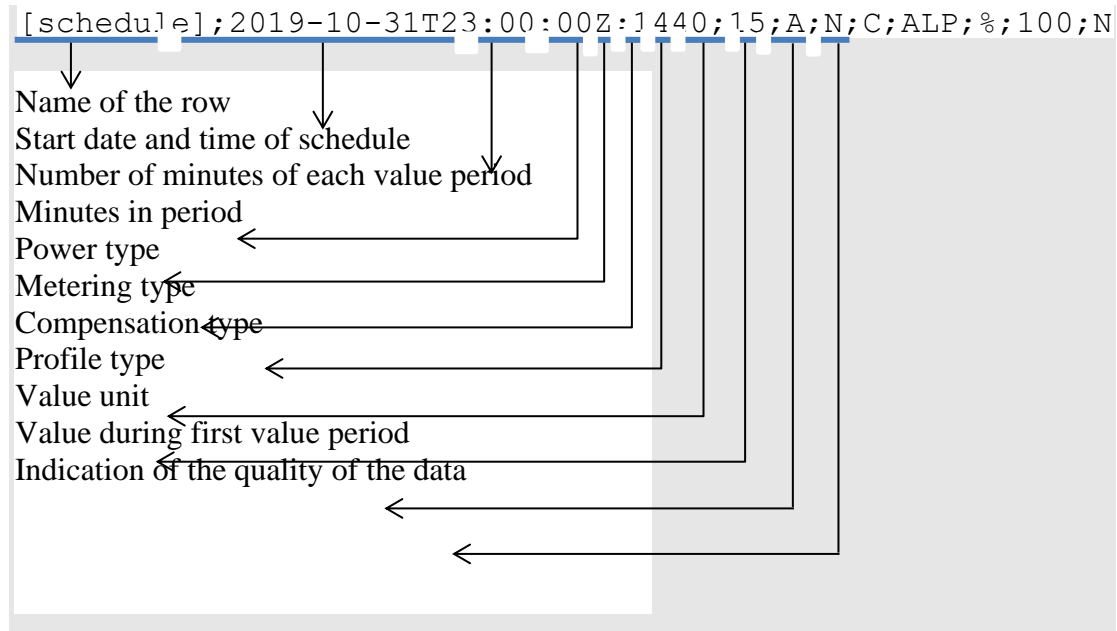

2.9.3. XML Real-Time DGO Allocation

Real-Time DGO Allocation metering data is delivered in a format like the XML Imbalance message. The Real-Time DGO Allocation and Imbalance messages respect the **IEC standard 62325-451-4**. The structure therefore is briefly explained in this document but whole description is available on the IEC web store: <https://webstore.iec.ch/publication/29116>.

The XSD Schema reference is available on "3.1 Reference XSD".

```
<EnergyAccount_MarketDocument xsi:schemaLocation="urn:iec62325.351:tc57wg16:451-4:energyaccountdocument:4:0 iec62325-451-4-settlement_v4.xsd"
xmlns="urn:iec62325.351:tc57wg16:451-4:energyaccountdocument:4:0"
xmlns:xsi="http://www.w3.org/2001/XMLSchema-instance">
</EnergyAccount_MarketDocument>
```

Example 32 XML Real-Time DGO Allocation message root

The message begins with information about the sender of the message (Elia) and the receiver as well as the time when the message was created plus some information about the state of this message: This header is valid for all the Time Series.

Remark: the XML comments indicated in the message here below are for the reader comprehension and are not available in the message sent by Elia;

```
<mRID>Prediction_20191101_20191130</mRID><revisionNumber>10</revisionNumber>
<type>A12<!-- Imbalance report --></type>
<docStatus><value>A01</value></docStatus><!-- Intermediate -->
<process.processType>A99</process.processType> <!-- DGO Allocation -->
<process.classificationType>A01</process.classificationType> <!-- Detail -->
<sender_MarketParticipant.mRID
codingScheme="A01">10X1001A1001A094</sender_MarketParticipant.mRID>
<sender_MarketParticipant.marketRole.type>A04</sender_MarketParticipant.marketRole.type>
<receiver_MarketParticipant.mRID codingScheme="A01">22XBRPA-----
A</receiver_MarketParticipant.mRID>
<receiver_MarketParticipant.marketRole.type>A08</receiver_MarketParticipant.marketRole.type>
<!-- Balance responsible party -->
<createdDateTime>2019-09-14T22:00:00Z</createdDateTime>
<period.timeInterval>
<start>2019-09-13T22:00:00Z</start>
<end>2019-09-14T22:00:00Z </end>
</period.timeInterval>
<domain.mRID codingScheme="A01">10YBE-----2</domain.mRID>
```

Example 33 XML Real-Time DGO Allocation message header

The <TimeSeries> element describes the flow of the power for one component and related criteria and the schedule of actual power values.

Elia does not guarantee the order of Timeseries within the message.

```

<TimeSeries>
<mRID>A03-22XBRPA-----A</mRID>
<businessType>Z22</businessType>
<!-- The latest calculated value of the real-time estimate in KW -->
<product>8716867000016</product>
<objectAggregation>A03</objectAggregation>
<area_Domain.mRID codingScheme="A01">10YBE-----2</area_Domain.mRID>
<marketParticipant.mRID codingScheme="A01">22XBRPA-----A
</marketParticipant.mRID>
<measure_Unit.name>KWT</measure_Unit.name>
...
</TimeSeries>
<TimeSeries>
<mRID>Z23_22X20121009---F4</mRID>
<businessType>Z23</businessType> <!-- The quality of the estimation, in % -->
<product>8716867000016</product>
<MeteringType>A01</MeteringType>
<CalculationMethod>A01</CalculationMethod>
<objectAggregation>A03</objectAggregation>
<area_Domain.mRID codingScheme="A01">22X20121009---F4</area_Domain.mRID>
<measure_Unit.name>%</measure_Unit.name>
...
</TimeSeries>

```

Example 34 XML Real-Time DGO Allocation message TimeSeries

The general meaning of these fields is given in The Metering Manual Concept. The business types for the components are listed in "2.9.1

Real-Time DGO Allocation components".



2.9.4. Excel (XLSX) Real-Time DGO Allocation

The Excel file contains one sheet. This sheet contains all information about the real-time DGO allocation, both the estimation and estimation quality:

- The top rows contain information about the receiver, the status of the message and the time of creation (last update) of the message and the fact that this sheet follow the Imbalance message format
- Subsequent area of the sheet is divided into columns
- The first lines of the columns give information about the component name, Direction (Power Flow), Party or Area) described "2.9.1 Real-Time DGO Allocation components".

The quarter hourly values give the power value and the estimated quality percentage for the mentioned metering data

1	Company	A03-22XTEST-ARP-ARP		Test ARP			
2	Last Update	02-08-2020		Prediction			
3	Status	Intermediate					
4	Version	229					
5							
6		Component		DGOAllocationEstimateQuality		DGOAllocationEstimateTotal	
7		Direction		Incoming		Incoming	
8		Description					
9				Value	Quality	Value	Quality
10		Monthly energy		3 KWh	Valid	-413.098 KWh	Valid
11							
12		Quarter hourly values					
13		Date	From To	%		W	
14		01-08-2020	00:00 00:15	100 N		-14.340.000	N
15		01-08-2020	00:15 00:30	100 N		-14.150.000	N
16		01-08-2020	00:30 00:45	100 N		-14.140.000	N
17		01-08-2020	00:45 01:00	100 N		-14.340.000	N
18		01-08-2020	01:00 01:15	100 N		-13.460.000	N
19		01-08-2020	01:15 01:30	100 N		-14.220.000	N
20		01-08-2020	01:30 01:45	100 N		-14.320.000	N
21		01-08-2020	01:45 02:00	100 N		-13.950.000	N
22		01-08-2020	02:00 02:15	100 N		-13.670.000	N
23		01-08-2020	02:15 02:30	100 N		-13.220.000	N
24		01-08-2020	02:30 02:45	100 N		-13.350.000	N
25		01-08-2020	02:45 03:00	100 N		-13.410.000	N
26		01-08-2020	03:00 03:15	100 N		-13.300.000	N
27		01-08-2020	03:15 03:30	100 N		-13.260.000	N
28		01-08-2020	03:30 03:45	100 N		-13.070.000	N
29		01-08-2020	03:45 04:00	100 N		-13.050.000	N
30		01-08-2020	04:00 04:15	100 N		-12.970.000	N
31		01-08-2020	04:15 04:30	100 N		-12.750.000	N
32		01-08-2020	04:30 04:45	100 N		-12.660.000	N

Example 35 Excel Real-Time DGO Allocation sheet

Chapter 3 XML format messages

3.1. Reference XSD

Elia XML messages allow automatic validation by the client application using only the “XML Schemas” (XSD).

Schema	Description
http://nedi1.elia.be/namespaces/public/metering/Publication.xsd	<ul style="list-style-type: none"> • Access Point messages. • GEMP messages • Metering Point messages
http://nedi1.elia.be/namespaces/public/metering/ELIA-iec62325-451-4-settlement.xsd http://nedi1.elia.be/namespaces/public/Metering/urn-entsoe-eu-wgedi-codelists.xsd http://nedi1.elia.be/namespaces/public/Metering/urn-entsoe-eu-local-extension-types.xsd	Local implementation of the standard where 2 fields (meteringType and calculationMethod) and local codes have been added

3.2. XML elements

This section describes the XML elements that are contained within other elements. These include:

- "party" elements
- "point" elements
- "schedule" elements

3.2.1. Party elements

Party elements refer to:

- <sender> the sender of the metering message
- <receiver> the receiver of the metering message
- <partyFrom> the party from which the power is flowing
- <partyTo> the party to which the power is flowing

An example of a <sender> is shown below:

```
<sender>
  <code>5499770302608</code>
  <codeType>C01</codeType>
  <friendlyName>ELIA</friendlyName>
  <role>R01</role>
</sender>
```

Example 36 XML Party elements

The contents of the party element are listed in the table below. Details on the different data types are given in section 3.2.

Element	Cardinality	Data type	Description
<code>	mandatory	string	Party identification code
<codeType>	mandatory	string	Code type. Possible values are: <ul style="list-style-type: none"> • C01: EAN code *(see note below) • C02: DVG code • C03: EIC code *(see note below) • C11: ELIA proprietary coding scheme
<friendlyName>	optional	string	Name to easily identify the party
<role>	mandatory	string	Role of the party. Possible values are: <ul style="list-style-type: none"> • R01: Transmission System Operator (TSO) • R02: Metering Reading Company (MRCO) • R03: Grid User (GU) • R04: Access Contract Holder (ACH) • R05: Balance Responsible Party (BRP) • R06: Distribution Grid Operator (DGO) • R07: Supplier • R08: ENergy COordinator (ENCO) • R09: Metering Contract Holder (MCH)

Table 52 XML Party element contents

* For messages concerning MRCO and DGO, the EAN code is used. For messages concerning direct clients, the EIC code is used.

Point elements

Point elements are used to identify access or Metering Points. An example of an Access Point description is shown below:

```
<point>
  <code>8400001000009</code>
  <codeType>C01</codeType>
  <friendlyName>accessPoint4</friendlyName>
</point>
```

The contents of the <point> element are listed in the table below. Details on the different data types are given in section 3.2.

Element	Cardinality	Data type	Description
<code>	mandatory	string	Point identification code
<codeType>	mandatory	string	Fixed. Always C01 : EAN code
<friendlyName>	optional	string	Name to easily identify the point.

Table 53 XML Point element contents

Schedule elements

<schedule> elements contain all the fields that describe the metered data as well as the data values themselves. They occur in all message types.

An example of a <schedule> element is given below. Not all data values are shown.

```
<schedule>
  <beginDateTime>2001-12-31T23:00:00Z</beginDateTime>
  <duration>4320</duration>
  <period>15</period>
  <unit>W</unit>
  <powerType>A</powerType>
  <meteringType>N</meteringType>
  <compType>C</compType>
  <profile>ULP</profile>
+ <v-list>
  <v>4000.000</v>
  Etc: not all values represented in this example
  <v>2874000.000</v>
</v-list>
+ <q-list>
  <q>N</q>
  Etc: not all quality flags represented in this example
  <q>N</q>
</q-list>
  <validated>false</validated>
</schedule>
```

Example 37 XML <schedule> element

The contents of the <schedule> element are listed in the table below. Details on the different data types are given in section 3.2.

Elements	Cardinality	Data type	Description
<beginDateTime>	mandatory	Date time	Date and time of the beginning of the schedule
<duration>	mandatory	integer	Total number of minutes of the schedule. This must be a multiple of a period.
<period>	mandatory	integer	The number of minutes for each value period. This always has the value 15 minutes.
<unit>	mandatory	string	Unit in which the values are defined. These are usually units of power (see Metering Manual Concepts) but can be other units for Metering Point messages.
<powerType>	optional	string	Identification of the type of power* (see Metering Manual Concepts). Possible values are: <ul style="list-style-type: none"> • A: Active • I: Inductive • C: Capacitive * this has no meaning for Metering Point messages containing non-power values.

<meteringType>	Optional (default=N)	string	<p>Indication as to whether the values are net or gross* (see Metering Manual Concepts).</p> <p>Possible values are:</p> <ul style="list-style-type: none"> • N: Net • G: Gross • SP: Corrections for energy transactions performed in the context of Multiple BRPs. • FA: Corrections for energy transactions performed in the context of Individual Correction for aFRR. • FM : Corrections for energy transactions performed in the context of Individual Correction for mFRR. <p>* this has no meaning for Metering Point messages containing non-power values. ** FOR DGOs and MRCOs only Net is used.</p>
<compType>	Optional (default=NC)	string	<p>Indication as to whether the values are compensated* or not (see Metering Manual Concepts).</p> <p>Possible values are:</p> <ul style="list-style-type: none"> • NC: Non-Compensated. Used for metering purposes. • C: Compensated. Used for billing purposes • CC: Compensated Corrected used for billing purposes only if corrections for energy transactions performed in the context of Multiple BRPs or Individual Correction (aFRR & mFRR) exist. <p>* this has no meaning for Metering Point messages containing non-power values.</p>
<profile>	Optional (default=ULP)	string	<p>Indication of the load profile. This is field is only for information purposes and is ignored by the Metering Application.</p>
<v>	0 <= n	list of decimal	<p>Value of the transferred power. The value is always positive. The value is expressed in the defined unit and contains a maximum of 3 digits after the decimal point.</p>

			The number of values = duration/period.
<q>	0 <= n	list of string	<p>Indication as to the quality of the metered data (see Metering Manual Concepts).</p> <p>Possible values are:</p> <ul style="list-style-type: none"> • N: Normal • I: Inexact • S: Substituted (Estimated replacement). <p>Number of values must be =duration/period.</p>
<validated>	mandatory	boolean	<p>Indication as to whether the values are valid or not (see Metering Manual Concepts).</p> <p>Possible values are:</p> <ul style="list-style-type: none"> • True: validated by Elia • False: not validated by Elia

Table 54 XML Schedule element contents

3.3. Data types

The following table describes all the data types allowed in XML data structure specifications.

Data type	Typical XML representation	Lexical pattern	Comments
string		.*	The following constraints can be expressed: minimum length, maximum length, pattern, choice of valid values
int	-1, 0, 126789675 +100000	[$-+$]?[0-9]+	The following constraints can be expressed: minimum value, maximum value. Values must be between 2147483647 and -2147483648 inclusive.
decimal	-1.23, 12678967.543 233, +100000.00, 210	[$-+$]?[0-9]+(\.[0-9]+)?	The following constraints can be expressed: minimum value, maximum value. Values must have at most 28 digits.
boolean	1, 0, true, false	1 0 true false	
code		.*	This is similar to string, but allowed values must be part of a documented "code table". The actual signification of the code table constraint is application-dependent.
datetime	1999-05-31T13:20:00+02:00	[0-9]{4}-[0-9]{2}-[0-9]{2}T[0-9]{2}:[0-9]{2}:[0-9]{2}?($[+-]$)[0-9]{2}(:[0-9]{2})??	Represents a time instant. If the time zone offset is not indicated, UTC is assumed. See section 4.5.2 on time formatting and daylight saving time handling.
time	13:20:00+02:00	[0-9]{2}(:[0-9]{2}:[0-9]{2})??($[+-]$)[0-9]{2}(:[0-9]{2})??	Represents a time instant in the day. If the time zone offset is not indicated, UTC is assumed. See section 4.5.2 on time formatting and daylight saving time handling.
date	1999-05-31	[0-9]{4}-[0-9]{2}-[0-9]{2}	Represents a calendar date. See section 4.5.2 on time formatting and daylight saving time handling.
binary		Encoded binary data (the default encoding is base64)	Used to transfer data that is not unicode text.

Table 55 Data types in XML formatted messages

Chapter 4 Accessing messages

Elia provides 3 different channels to deliver the messages to the clients:

- "eVMS B2C": The client can access on a dedicated metering webpage. He can manually download the messages on this web page. This channel is dedicated to Business operational persons wishing to easily download a few metering messages. Elia does not recommend implementing any automated way to download messages through "EvmsB2C"
- "EPIC": Grid Users can visualize their metering data in a graphical and tabular format on the EPIC Webportal as well as manually download the data. The EPIC export format is identical to the legacy .xlsx format available on eVMS B2C. This portal will fully replace the EVMS B2C webpage in the coming months.
- "SFTP": Clients can access their messages through the Elia SFTP servers.

4.1. Characteristics of the different channels

The 2 protocols have their own advantages and disadvantages. Here is a summary of the different advantages and disadvantages.

Protocol	Description	Advantages	Disadvantages
eVMS B2C	Web site	No investment from the client Zero learning time: Only a web browser is needed	The download is manual. Requires different user IDs for each legal entity within your group The password must be updated every 120 days.
EPIC	Website	No investment from client Easily share access to other colleagues Visualize data directly from the webpage	The download is manual. Metering Data is currently only available to Grid Users via this channel.
SFTP	Secure File Transfer Protocol	Existing protocol Allow full automatic connection to download the metering message in the client application	This protocol is not widely permitted: Some IT department block the use of this protocol The password must be updated every 120 days if no certificate is provided by the client: See "4.3.1 Use of certificates: Public key – private key "

4.2. The eVMS B2C website

Elia provides a proprietary application allowing clients to access their metering data using the HTTPS protocol. This is the Elia Validated Metering system for Business to Consumer ("eVMS B2C"). Clients can manually download their metering messages and save them on their disks

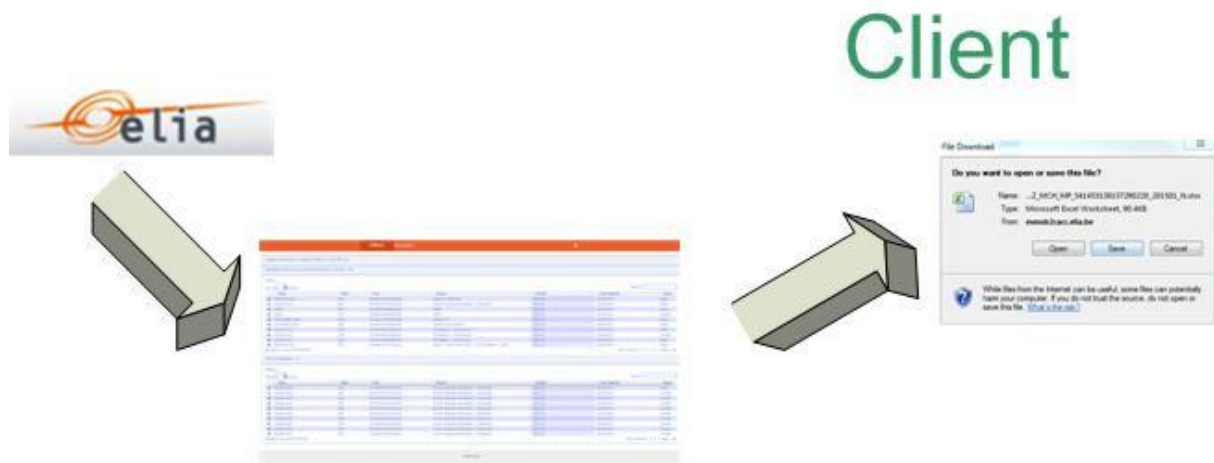

Figure 16 Delivery of metering data via the EVMSB2C web site

This delivery method is straightforward: When logged in, only one page is available with the last messages to be downloaded. A simple search can be used to easily retrieve the needed message

4.3. The EPIC Portal

Elia is working on the integration of its services to clients into one single 'one-stop shop' application. Metering Data is a cornerstone of this approach.

More information on how to create an account and access metering data on EPIC can be found on [the EPIC Help center](#).

4.4. SFTP server

SFTP or "Secure File Transfer Protocol" is a standard network protocol used to exchange files over a network. The protocol is easy to implement and is available on all types of computers and operating systems.

Using FTP has the following advantages:

- it is a well-known standard
- it is easy to implement
- it is Operating System independent
- it provides a secured file transfer
- SFTP works with a user id /password (exception: see Section 4.3.1)

To manage the metering messages, the diverse types are stored in separate subfolders. The client can list the contents of each folder. The messages (or files) can be read and stored locally on the file system and can be deleted after successful treatment.

The figure below shows a typical screenshot of a graphical user interface (SFTP client) showing the different subfolders.

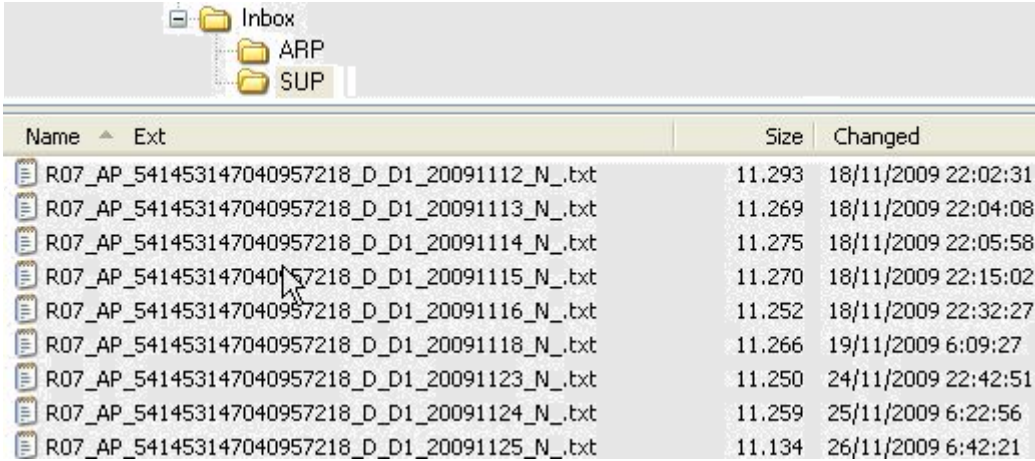

Name	Ext	Size	Changed
R07_AP_541453147040957218_D_D1_20091112_N_	.txt	11,293	18/11/2009 22:02:31
R07_AP_541453147040957218_D_D1_20091113_N_	.txt	11,269	18/11/2009 22:04:08
R07_AP_541453147040957218_D_D1_20091114_N_	.txt	11,275	18/11/2009 22:05:58
R07_AP_541453147040957218_D_D1_20091115_N_	.txt	11,270	18/11/2009 22:15:02
R07_AP_541453147040957218_D_D1_20091116_N_	.txt	11,252	18/11/2009 22:32:27
R07_AP_541453147040957218_D_D1_20091118_N_	.txt	11,266	19/11/2009 6:09:27
R07_AP_541453147040957218_D_D1_20091123_N_	.txt	11,250	24/11/2009 22:42:51
R07_AP_541453147040957218_D_D1_20091124_N_	.txt	11,259	25/11/2009 6:22:56
R07_AP_541453147040957218_D_D1_20091125_N_	.txt	11,134	26/11/2009 6:42:21

Figure 17 Folder structure on the Elia FTP client

Please contact your KAM or “metering Services” (see coordinates on the first page) to obtain a username and password to access the Elia FTP server.

4.4.1. Use of certificates: Public key – private key

One of the problems with the SFTP server is the use of a password: This password has an expiration time. Even if a reminder email can be sent to the client, it arrives that the password is expired, and the client is blocked if this one has an automated way to retrieve the messages.

To avoid the use of passwords, the client may use a certificate.

The certificate implements the concept of public and private key for authorization and authentication:

- A public key can be viewed as a lock device.
- A private key can be viewed as an actual key. This is the device used to open the 'lock' (Public key) that is stored on the other machine.

Like a regular key, the private key must be kept secret, safe, and out of the wrong hands.



Figure 18 Private and public key images

Just like a real-life key system, it is not a problem if there are hundreds of the same 'lock' on many systems if the private key stays ... private.

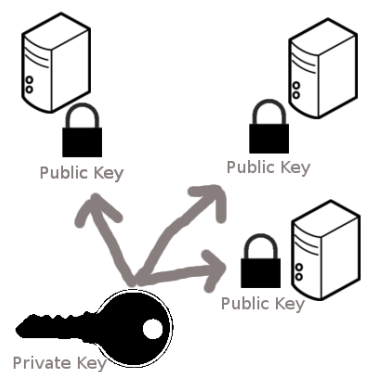

Figure 19 Private and public key on computers

This public key can therefore be distributed anywhere. Currently most companies have such a certificate composed of a private and public key: check with your IT department. When this public key is put on the Elia SFTP server, this one will be used and no longer the password.

Please contact your KAM or "metering Services" (see coordinates on the first page) to place your public key on the Elia's SFTP server.

4.5. Metering messages name

Each protocol uses a name (title) to allow distinguishing the message: It can be the file name downloaded from the EVMSB2C or the SFTP server.

This chapter lists, for each protocol how each file name or "message type" is constructed

4.5.1. eVMS B2C / EPIC message file names

The type of a metering message when downloaded is a string constructed as follows:

[Recipient EIC]_[Recipient role]_[MsgType]_[Meterable EAN]_[YearMonth]_[Validity].[Extension]

- [Recipient EIC] is the EIC of the message recipient
- [RecipientRole] is the role of the recipient of the message and can take the values:

[RecipientRole]	Description
ACH	Access Contract Holder
ARP	Access Responsible Party (Former name of the BRP)
BSP	Balance Service Provider / Flexibility Service Provider
GU	Grid User
GLOBAL	Metering Contract Holder
PROD	Producer
SUP	Supplier

- [MsgType] refers to the type of the message and can take the values:

[MsgType]	Description	Remark
AP	Access Point & Real-Time DGO Allocation	
CA	CDS Access Point	Same format as Access Point
GEMP	Global Elia Metering Position	
IMB	Imbalance	
MP	Metering Point	
SP	SubAccess Delivery Point	Same format as Access Point

- [Meterable EAN] is the EAN code identifying the point referenced by this message. If there is no such object, then "000000000000000000" is used
- [YearMonth] is the year and month covered... Format "YYYYMM"
- [Validity] indicate if the message is validated or not

[Validity]	Description
V	Validated
N	Not Validated

- [Extension] is the publication format and can take the values:

[PubFormat]	Description
CSV	Comma Separated Values
XLSX	Excel file
XML	eXtensible Markup Language

FTP Metering message file names

The file name of the metering message. It is constructed according to the following pattern:

[RecipientRole]_[MsgType]_[EAN-code]_M_M1_[schedule-time]_Validity_Id.Extension

- [RecipientRole]:

[Recipient Role]	Description
R03	Grid User (GU)
R04	Access Contract Holder (ACH)
R05	Balance Responsible Party (BRP)
R07	Supplier
R08	Producer
R09	Metering Contract Holder (MCH)
R12	Balance Service provider (BSP) / Flexibility Service Provider (FSP)

- [MsgType] refers to the type of the message and can take the values:

[MsgType]	Description	Remark
AP	Access Point & Real-Time DGO Allocation	
CA	CDS Access Point	Same format as Access Point
GEMP	Global Elia Metering Position	
IMB	Imbalance	
MP	Metering Point	
SP	SubAccess Delivery Point	Same format as Access Point

- [EAN-code] is the EAN code identifying the point referenced by this message. If there is no such object, then "000000000000000000" is used
- [schedule-time]: yyymm
- [Validity] indicate if the message is validated or not

[Validity]	Description
V	Validated
N	Not Validated

- Id = unique identifier of the message
- Extension] is the publication format and can take the values:

[PubFormat]	Description
CSV	Comma Separated Values
XLSX	Excel file
XML	eXtensible Markup Language

Examples of non-validated filenames:

- R03_AP_541453166475361582_M_M1_200603_N_1716367.txt
- R04_AP_541453199001109600_M_M1_200603_N_1720579.txt
- R09_MP_541453155970400575_M_M1_200603_N_1720367.txt

Example of validated filename:

- R03_AP_541453132606828217_M_M1_200602_V_1716404.txt
- R12_AP_541453104544500333_M_M1_201508_V_178954.txt
- R12_SP_541453104544500340_M_M1_201611_V_123456.xlsx
- R12_MP_541453104544500357_M_M1_201712_V_78954.xml
- R12_CA_541453104544500364]_M_M1_201701_V_789654.txt

4.6. Time formatting and Daylight saving

This section describes the format of times and dates used in metering messages and deals with the issues arising from daylight saving.

4.6.1. Time and date formatting

Times and dates are presented in the ISO 8601 format in CSV and XML formats. Date and time are expressed in UTC (Coordinated Universal Time) usually denoted by the letter Z. Time zones are expressed as an offset from UTC.

ISO 8601 format is:

`yyyy-mm-ddThh:nn:ssZ` or `yyyy-mm-ddThh:nn:ss+xx:yy`

Where:

`YYYY` = year

`mm` = month

`dd` = day

`T`: flag to indicate Time

`hh` = hour

`nn` = minute

`ss` = second

`Z` = Flag indicating that the time is in UTC

Or:

`+` = a flag to indicate the positive offset of the time from UTC

`xx:yy` = is the offset from UTC expresses in xx hours and yy minutes.

If the time zone offset is not indicated, UTC is assumed.

Examples

A local time of 1:20 pm on May 31st, 2009 in Brussels (which is 2 hours ahead of UTC) is written in UTC notation as:

`2009-05-31T11:20:00Z`

Or:

`2009-05-31T13:20:00+02:00`

The date, May the 31st 2019, is written as: `2019-05-31`

4.6.2. Daylight saving

Due to daylight saving measures, twice during the year the local time is changed by one hour, meaning one day contains only 23 hours and another 25 hours. This has implications on the contents of metering messages.

Date and time are expressed in UTC (Coordinated Universal Time).

So, during winter time, the day begins at 23:00h UTC (the equivalent of 00:00h local time). During summer time, the day begins at 22:00h UTC (the equivalent 00:00h local time).

For example, in summer time:

Local time	ISO format	UTC
1:20 pm on May 31st, 2009	2009-05-31T13:20:00+02:00	2009-05-31 11:20:00

In winter time

Local time	ISO format	UTC
1:20 pm on January 31st, 2009	2009-01-31T13:20:00+01:00	2009-05-31 12:20:00

The example below shows the transition from summer time to winter time in Belgium on the 31st of October in 2010.

Local time	ISO format	UTC
0h	2010-10-31 00:00+02	2010-10-30 22:00
1h	2010-10-31 01:00+02	2010-10-30 23:00
2h	2010-10-31 02:00+02	2010-10-31 00:00
at 3h it is 2h	2010-10-31 02:00+01	2010-10-31 01:00
3h	2010-10-31 03:00+01	2010-10-31 02:00

The example below shows the transition from winter time to summer time in Belgium on the 28th of March in 2010.

Local time	ISO format	UTC
0h	2010-03-28 00:00+01	2010-03-27 23:00
1h	2010-03-28 01:00+01	2010-03-28 00:00
at 2h it is 3h	2010-03-28 03:00+02	2010-03-28 01:00
4h	2010-03-28 04:00+02	2010-03-28 02:00

Value periods in a message

The metering message is composed of power values for each quarter ('value periods') of each day of a month. The number of value periods in a message depends on the number of hours in the day and the number of days in the month.

For a 'normal' 24 hour day:
 number of minutes = 1440
 number of value periods $1440 / 15 = 96$
 All 96 values and qualities are consecutive.

For a 23 hour day:
 number of minutes = 1380
 number of value periods $1380 / 15 = 92$
 The value periods between 2h and 3h are omitted. There are therefore 4 less value periods in the daily message and the corresponding message.

For a 25 hour day:
 number of minutes = 1500
 number of value periods $1500 / 15 = 100$
 Four additional values periods are inserted after the 2h-3h value periods. There are 4 additional values periods in both the daily message and the corresponding message

For a 28 day month:
 number of minutes = 40320
 number of value periods $40320 / 15 = 2688$

For a 29 day month:
 number of minutes = 41760
 number of value periods $41760 / 15 = 2784$

For a 30 day month:
 number of minutes = 43200
 number of value periods $43200 / 15 = 2880$

For a 31 day month:
 number of minutes = 44640
 number of value periods $44640 / 15 = 2976$

In Excel files, on 23 hours day, the hour is not present:

96	29-03-2014	23:30	23:45	7,360,478	N	560,082	N	
97	29-03-2014	23:45	00:00	7,085,324	N	280,774	N	1
98	30-03-2014	00:00	00:15	6,991,489	N	0	N	2
99	30-03-2014	00:15	00:30	6,782,802	N	610,176	N	
00	30-03-2014	00:30	00:45	6,464,641	N	804,201	N	
01	30-03-2014	00:45	01:00	6,337,327	N	800,291	N	
02	30-03-2014	01:00	01:15	6,170,427	N	824,727	N	
03	30-03-2014	01:15	01:30	6,160,408	N	815,686	N	
04	30-03-2014	01:30	01:45	6,175,070	N	808,844	N	
05	30-03-2014	01:45	03:00	6,031,384	N	810,554	N	
06	30-03-2014	03:00	03:15	6,000,350	N	774,388	N	
07	30-03-2014	03:15	03:30	5,902,849	N	766,813	N	

In Excel files, on 25 hours day, the hour is present 2 times with an asterisk

Appendix A. Glossary of terms

Client

A company that holds a contract with Elia, which entitles the latter to metering messages. The messages received depend on the market "roles" that the client has. One client may perform several roles. A client receives metering messages for each of its market roles.

Injection

Energy (produced by a producer) that is injected into the Elia grid

Non-regulated metering

A message containing specific metering data requested by a client and defined in a contract. This one can contain values for quantities other than power.

Offtake

Consumption of energy by a client connected to the Elia Grid

Protocol

A set of rules governing the format of messages that are exchanged between computers

Receiver

The recipient of a metering message

Region

A region within Belgium that is controlled by a specific regulator

Role

A function executed by a client, as defined in a contract. See section "1.1.1 Market roles "

Schedule

The series of values contained in a metering message. A schedule contains values for each day of a month. The time is indicated by the value of the duration field which is given in minutes.

Sender

Party who sends a metering message

Source

The provider of the metering data

Validation

This is the process whereby the quantities referred to in a message are deemed to be correct. See section 1.1.3

Volt-Amperes-Reactive

Unit of reactive power (VAR)

Watt

Unit of active power (W)