



PROPOSAL FOR NC RfG REQUIREMENTS OF GENERAL APPLICATION

TSO proposal following Art. 7(4) of the NC RfG

17 May 2018

Contents

1	Introduction	3
2	Proposal for determination of significance [Art 5]	5
2.1	Conditions for the choice of the maximum capacity thresholds	6
2.1.1	Voltage withstand Capabilities for PGM connected to TSO	6
2.1.2	Other conditions	7
3	Type A Requirements	8
3.1	Frequency Requirements	8
3.1.1	Frequency withstand capability [Art. 13-1 (a)]	8
3.1.2	Rate Of Change Of Frequency (ROCOF) withstand capability [Art 13.1(b)]	8
3.1.3	Loss Loss of Main Protection triggered by rate-of-change-of-frequency-type [Art 13.1(b)]	9
3.1.4	Limited Frequency Sensitive Mode – Over frequency (LFSM-O) [Art. 13-2 (a-g)]	9
3.1.5	Admissible maximum power reduction with falling frequency [Art. 13-4]	11
3.1.6	Logical interface to cease active power injection [Art 13-6]	12
3.1.7	Automatic connection [Art 13-7]	12
4	Type B Requirements	13
4.1	Frequency stability and active power management	13
4.1.1	Remote control reduction of active power [Art 14 -2]	13
4.1.1	Automatic reconnection [Art 14-4 (a-b)]	13
4.2	Instrumentation [Art 14-5]	13
4.2.1	Structural data: control and electrical protection schemes and settings [Art 14-5 (a + b)]	13
4.2.2	Information exchanges [Art 14-5(d)]	14
4.3	Type B – SPGM Requirements	15
4.3.1	Reactive power capabilities - SPGM [Art 17-2(a)]	15
4.3.2	Voltage Control SPGM type B [Art 17-2 (b)]	16
4.3.3	Fault-ride through for symmetrical and asymmetrical faults for SPGM [Art 14-3]	16
4.3.4	Post-fault active power recovery - SPGM [Art 17-3]	17
4.4	Type B – PPM Requirements	18
4.4.1	Fault-ride through for symmetrical and asymmetrical faults - PPM [Art 14.3]	18
4.4.2	Reactive capabilities - PPM [Art 20-2(a)]	18
4.4.3	Fault Current & dynamic voltage support [Art 20-2 (b and c)]	20
4.4.4	Post-fault active power recovery [Art 20-3]	20
5	Type C Requirements	21
5.1	Frequency stability & Active Power management	21
5.1.1	Active Power Controllability and Control Range [Art. 15-2 (a-b)]	21
5.1.2	Limited frequency sensitive mode – under frequency (LFSM-U) [Art. 15-2 (c)]	21
5.1.3	Frequency Sensitive Mode [Art. 15.2.d]	22
5.1.4	Frequency restoration control [Art 15-2.e]	23
5.1.5	Real-time monitoring of FSM [Art 15-2.g]	23
5.1.6	Automatic disconnection for voltage outside ranges [Art 15-3]	23
5.1.7	Rates of change of active power output [Art 15-6(e)]	23
5.2	System restoration [Art 15-5]	24
5.2.1	Capability to take part in island operation [Art 15.5(b)]	24
5.2.2	Quick resynchronization capability [Art 15-5(c)]	24
5.3	Instrumentation, simulation and protection	24
5.3.1	Loss of angular stability or loss of control [Art 15.6(a)]	24
5.3.2	Instrumentation [Art 15.6(b)]	24
5.3.3	Simulation models [Art 15.6(c)]	24
5.3.4	Devices for system operation and security [Art 15.6(d)]	24

5.3.5	Earthing of the neutral point at the network side of the step-up transformer [Art 15.6(f)]	25
5.4	Voltage control mode (for SPGM and PPM) [Art 19-2(a) and Art 21.3(d)]	25
5.5	Type C SPGM Requirements	26
5.5.1	Reactive power capability SPGMs [Art 18-2]	26
5.5.2	Voltage control requirements for SPGM type C	26
5.6	Type C PPM Requirements	27
5.6.1	Synthetic inertia for PPM [Art 21-2]	27
5.6.2	Reactive capabilities - PPM [Art 21-3(a-c)]	27
5.6.3	Voltage control - PPM [Art 21-3 (d) and (e)]	28
6	Type D Requirements	29
6.1	Voltage Control	29
6.1.1	Voltage withstand capability [Art 16-2(a & b)]	29
6.1.2	Automatic disconnection for voltage outside ranges [Art 16-2(c)]	29
6.2	Resynchronization [Art 16-4]	29
6.3	Type D SPGM Requirements	30
6.3.1	Fault-ride through for symmetrical and asymmetrical faults – SPGM [Art 16-3]	30
6.3.2	Voltage stability SPGM [Art 19-2]	31
6.3.3	Technical capabilities to support angular stability under fault conditions for SPGM [Art 19-3]	31
6.4	Type D - PPM	31
6.4.1	Fault-ride through for symmetrical and asymmetrical faults – PPM [Art 16-3]	31
7	Acronyms	33
8	References	33
9	Appendix I – Definition FRT profile (extract from Art. 14.3 RfG[1])	34
10	Appendix II - List of non-exhaustive articles for RfG	34

1 Introduction

Article 7(4) of the NC RfG [1] states that the relevant system operator or TSO submits a proposal for requirements of general application (or the methodology used to calculate or establish them), for approval by the competent entity, within two years of entry into force of the NC RfG, i.e. 17 May 2018. A similar requirement is included in the two other connection Network Codes, namely in Art. 6(4) of the NC DCC [2] and in Art. 5(4) of the NC HVDC [3].

The aim of this document is to synthesize the technical proposal regarding the Belgian implementation of the non-exhaustive requirements stated in the NC RfG. This document is the final version of the proposal for requirements of general application (hereafter named as ‘general requirements’), in accordance with Art. 7(4) of the NC RfG.

The proposal is mainly focusing on requirements set by Elia, as (relevant) TSO or relevant system operator. Since the public DSOs were also largely involved in developing the TSO proposal or in defining their own implementation proposals for PGMs (power generating modules) connected to the public distribution system, part of the requirements is also set by the public DSOs, as relevant system operator.

To facilitate the implementation of the NC RfG requirements, Elia and the public DSOs aligned as much as possible to increase the coherency and avoid as much as possible discrimination between a transmission-, or distribution-connected PGM in terms of technical requirements and legal readability. For aspects of the general requirements relevant for CDSOs, Elia has also been interacting with CDSOs.

On 17 May 2018, Elia has submitted the final proposals for general requirements for NC RfG, but also for NC DCC and NC HVDC to the competent authorities together with the (track change) proposal of the amended Federal Grid Code [4] and the formal proposal on maximum capacity thresholds of type B, C and D PGM. Elia has organized beforehand a public consultation for all deliverables from 15 March up to and including 16/23 April 2018, except for the public consultation on the maximum capacity thresholds B, C and D, that already took place from 19 May till 20 June 2017. This approach is in line with the vision of the Belgian Federal Administration (FOD/SPF Energy) [5].

This document represents the final position of Elia after discussions with the stakeholders in each of the relevant topics. During the last months, this document was gradually completed and presented to stakeholders, especially during the Federal Grid Code workshops, until all non-exhaustive general requirements were included.

This document should be considered as a technical but not legally binding document, focusing on the clarification of various technical general requirements that will be reflected in various grid codes, contracts, terms and conditions, regulatory documents and/or technical prescriptions.

The document follows the same article order as in the NC RfG: the proposal is organized per technical topic and per PGM category, assuming the thresholds B, C and D as defined in Elia’s (and public DSOs’) proposal. If not otherwise specified, each higher category has to fulfil the requirement of the lower one. As an example, the LFSM-O is specified for type A, but it is also valid for types B, C and/or D PGMs.

The scope of this document contains especially, but is not limited to, the implementation proposal of the non-exhaustive requirements in the NC RfG. To increase its readability, this document might also contain NC exhaustive requirements, implementation proposals of non-exhaustive requirements of the other connection NC, or other specific national/regional requirements for information purposes only, but certainly does not cover all of them.

With respect to the complete list of non-exhaustive requirements to be proposed as general requirements, Elia is taking as reference the ENTSO-E implementation guidance document (IGD) on ‘Parameter of Non-exhaustive requirements’ [6] to be defined by the (relevant) TSO and the relevant system operator. This document does not only mention the parameters to be defined per topic, but also which article of each connection NC should be considered as non-exhaustive and who should be the relevant system operator to define an implementation proposal. The TSO, public DSOs and CDSOs can be considered as ‘relevant system operator’, depending on the requirement.

As a general consideration, the present document proposes minimum requirements. If a PGM has capabilities beyond the minimum requirements and its utilization has no negative technical impacts on its normal operation, this capability should be available for activation in agreement with the relevant system operator (note: for Elia this will be defined during connection agreement). As a matter of example, should the PGM have capabilities beyond the minimum Fault Ride Through profile (cf. Art. 14-3), the PGM is expected not to limit its capabilities to comply with the minimum requirement but to use the full capability to support the system stability as stated in its agreement. The actually implemented PGM characteristics and functionalities must be communicated to the relevant system operator and/or transmission system operator.

In line with NC RfG article 3.2(b) the general requirements are not applicable to backup-power PGM¹, unless these PGM are offering ancillary services on a voluntary basis for more than 5 minutes a month.

¹ Power-generating modules that were installed to provide back-up power and operate in parallel with the system for less than five minutes per calendar month while the system is in normal system state. Parallel operation during maintenance or commissioning tests of that power-generating module shall not count towards the five-minute limit.

2 Proposal for determination of significance [Art 5]

The current proposal for determination of significance has been shared with the stakeholders through the “Public consultation relating to the proposal for maximum capacity thresholds for types B, C and D power-generating modules” running from 19/05/2017 to 20/06/2017 and is available [online](#). The proposed thresholds are the result of several rounds of workshops and discussions with the stakeholders and the authorities. A synthesis of the proposed determination of significance is presented here below.

In line with the NC RfG Art. 5, Elia is proposing the following choice of maximum capacity thresholds for the determination of type:

- Type A
 - $0.8kW \leq P_{MAX}^{Capacity} < 1 MW$ and $V_{cp} < 110kV$
- Type B
 - $1 MW \leq P_{MAX}^{Capacity} < 25MW$ and $V_{cp} < 110kV$
- Type C
 - $25MW \leq P_{MAX}^{Capacity} < 75MW$ and $V_{cp} < 110kV$
- Type D
 - $75MW \leq P_{MAX}^{Capacity}$ or
 - $0.8kW \leq P_{MAX}^{Capacity}$ and $V_{cp} \geq 110kV$

Where $P_{MAX}^{Capacity}$ is the maximum (installed) capacity of the power-generating modules and V_{cp} is the voltage level at the connection point.

The parameters for the determination of significance are graphically illustrated in Figure 1 below.

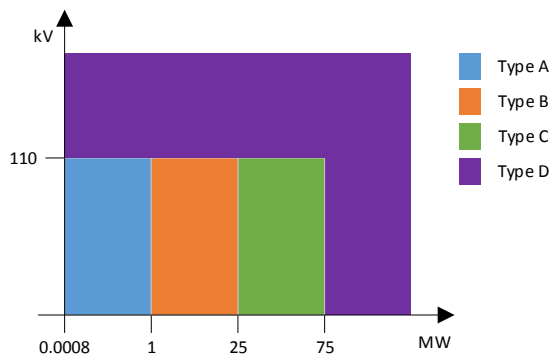

Figure 1 : Graphical representation of the proposed maximum capacity thresholds.

However, Elia is proposing to adapt the requirements for power-generating modules (PGM) with a maximum installed capacity lower than 25MW and with a voltage at the connection point higher or equal to 110kV, in order to reflect the specification of the PGM of the same size with a voltage at the connection point lower or equal to 110kV. The requirements will be adapted via a request for derogation submitted by the relevant system operator or, in this case, the relevant TSO (in line with NC RfG Art. 6.3).

More specifically the following requirements are proposed:

- Type D PGM having a $0.8kW \leq P_{MAX}^{Capacity} < 1 MW$ will follow the same requirements as type A PGM
- Type D PGM having $1 MW \leq P_{MAX}^{Capacity} < 25MW$ will follow the same requirements as type B PGM.

A graphical representation of the expected resulting requirements is presented in Figure 2 below.

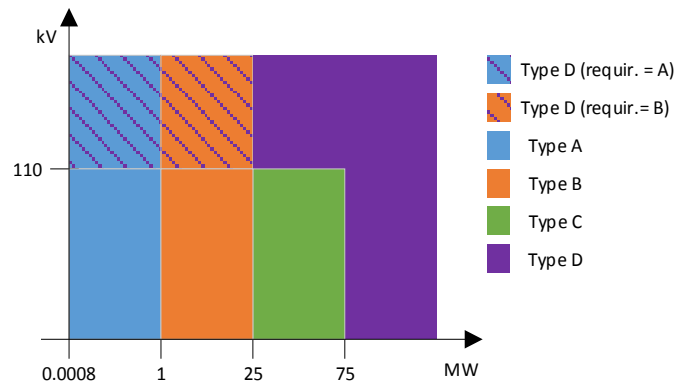

Figure 2 : Graphical representation of the requirements to be followed by PGM depending on the proposed maximum capacity thresholds considering the results of the intended derogation process.

It must be noted that the Power Park Modules (PPM), for which the connection point is located off-shore should follow the same prescriptions as type D PPM units except if specifically defined in the present document.

2.1 Conditions for the choice of the maximum capacity thresholds

2.1.1 Voltage withstand Capabilities for PGM connected to TSO

This requirement should be met at the connection point.

Voltage withstand capabilities are only mentioned in RfG for type D PGMs (art 16.2), similar capabilities (cfr. Table 1) are necessary for other PGMs, in order to guarantee safe operation of the grid.

	Voltage Range	Time period for operation
Voltage ranges below 300kV	0.85 pu – 0.90 pu	60 minutes
	0.90 pu – 1.118 pu	Unlimited
	1.118 pu – 1.15 pu	To be agreed between the TSO and the facility owner in the connection agreement
Voltage ranges above 300kV	0.85 pu – 0.90 pu	60 minutes
	0.90 pu – 1.05 pu	Unlimited
	1.05 pu – 1.10 pu	To be agreed between the TSO and the facility owner in the connection agreement

Table 1: Voltage withstand capabilities

The following base values are to be considered for PGM connected to TSO network:

- 400kV
- 220kV
- 150kV
- 110kV

-
- 70kV
 - 36kV

In case of broader or longer voltage withstand capabilities technically and economically feasible, the owner of the installation should put this at disposal of the relevant system operator.

2.1.2 Other conditions

For type C Synchronous Power Generating Modules (SPGM), stricter requirements than foreseen by the NC RfG for which regards voltage regulations will be necessary, these requirements are already included in the existing FTR for units of the same type and size (cfr Art. 72 in [4]).

Elia requests Automatic Voltage Regulation (AVR), Over Excitation Limiter (OEL), Under Excitation Limiter (UEL) and Power System Stabilizer (PSS) functions. The activation and tuning of the PSS function will be required depending on the connection point, size and the characteristic of the SPGM.

This approach is in line with the Implementation Guidance Document, proposed and submitted by ENTSO-e, for national implementation of the network codes on grid connection (IGD) on “Parameters of Non-exhaustive requirements: it recommends a site specific implementation of the requirement Art. 19(2)b.(v) through individual connection contract.

Closed Distribution Systems (CDS) requirements will be aligned, to the greatest possible extent, to the ones of Demand Facilities and DSO.

3 Type A Requirements

In general all frequency related parameters are being coordinated between TSOs in the CE synchronous area to guarantee fair contribution among all control areas power generation units and overall resilience and stability of the system. The current requirements are based on the final Implementation Guideline Documents (IGD) that was submitted to public consultation in ENTSO-e website (closed 21 Dec 2017)².

3.1 Frequency Requirements

3.1.1 Frequency withstand capability [Art. 13-1 (a)]

Proposed frequency range and minimum time period are as following:

Frequency Range	Duration
[47,5 Hz – 48,5 Hz[30 minutes
[48,5 Hz – 49,0 Hz[30 minutes
[49,0 Hz – 51,0 Hz]	Unlimited
]51,0 Hz – 51,5 Hz]	30 minutes

Note: For PGMs connected to distribution grids, the protection settings should not be conflicting with this frequency withstand capability unless in case of local event detection (and not an overall power system event).

Moreover, in application to the paragraphs 13-1 (a)(ii) and (a)(iii), duration of operation in the frequency range from 51,5 Hz to 52,5 Hz shall be dealt with as follows:

- If the TSO (Elia) is the relevant system operator:
 - For units of type B, C and D this shall be agreed between the RSO (Elia) and the generating facility owner in the connection agreement taking into consideration the PGM's possible technical capability.
 - For units of type A, the power generating facility owner shall communicate their technical duration capability to the RSO and put it at disposal of the RSO.
- If the DSO (or the CDSO insofar the CDSO has not introduced separate or diverging NC RfG Requirements of General Application) is the relevant system operator:
 - For units of type A and B the RSO shall be informed of the technical duration capability which has to be put at disposal of the RSO. This information can be provided during the type compliance assessment (homologation).
 - For units of type C this shall be agreed between the RSO (DSO), in coordination with the relevant TSO, and the generating facility owner in the connection agreement taking into consideration the PGM's possible technical capability.

3.1.2 Rate Of Change Of Frequency (ROCOF) withstand capability [Art 13.1(b)]

The proposed RoCoF withstand capability is defined considering frequency against time profile as depicted in the Figure 3 with explicit measurement technique taking into consideration 2 Hz/s for a duration of 500 ms. For PGM connected to Transmission Network and relying on Loss Of Main (LOM) detection based on RoCoF measurement, the protection settings should not be conflicting with RoCoF withstanding capabilities requirements unless in case of local event detection (and not an overall power system event).

² https://consultations.entsoe.eu/system-development/entso-e-connection-codes-implementation-guidance-d-4/consult_view/

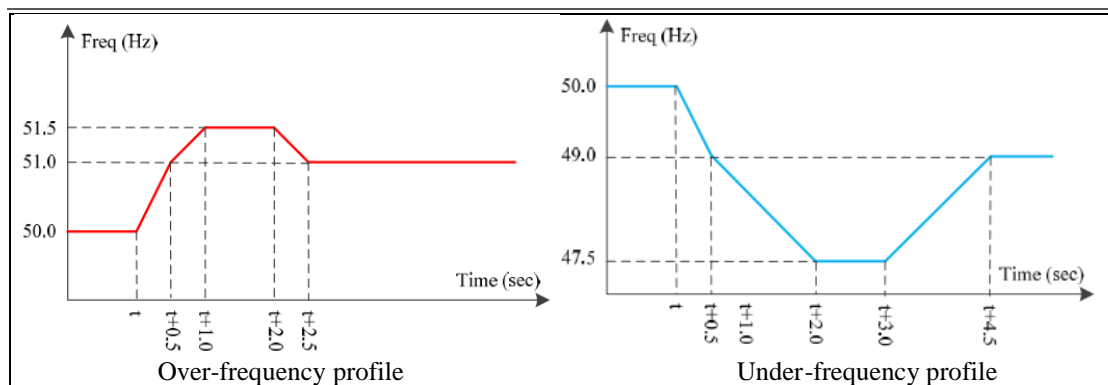

Figure 3 Proposed frequency against time withstanding capabilities

3.1.3 Loss of Main Protection triggered by rate-of-change-of-frequency [Art 13.1(b)]

For all PGM a LOM based on RoCoF may be used in coordination with the TSO.

For PGM connected to Transmission Network and relying on LOM detection based on RoCoF measurement, the threshold should be higher than 2 Hz/s for a duration of 500 ms, note that other alternative LOM detection settings should not conflict with frequency withstand capabilities requirements unless in case of local event detection (and not an overall power system event). For technical and safety reasons, lower thresholds can be discussed on a case by case.

For PGMs connected to distribution networks (or to CDSO network insofar the CDSO has not introduced separate or diverging NC RfG Requirements of General Application), a Loss of Mains protection based on a ROCOF measurement may be prescribed by the DSO. In line with Art 13.1(b) the public DSOs in coordination with the TSO actually prescribes a default setting of 1Hz/s. In such cases, the interface protection disconnects the PGM before the full withstanding capability is used. Nevertheless, the public DSOs investigate new protection strategies in order to achieve a better coordination.

3.1.4 Limited Frequency Sensitive Mode – Over frequency (LFSM-O) [Art. 13-2 (a-g)]

Definition of the non-exhaustive requirements related to LFSM-O function are coordinated between TSOs in the CE synchronous area. Due to the system-wide effect of frequency-related issues, a harmonised setting of these parameters within a synchronous area is desirable. Otherwise adverse impacts can occur, which may aggravate the emergency situations subsequent to the LFSM-O activation. Automatic disconnection and reconnection as referred in 13-2 (b) are not allowed by default.

Taking into consideration the system transient behaviour and the need for an adequate frequency response reaction, the proposal addresses as well the response performance while taking into consideration different PGM technologies.

The PGM response takes into consideration the following aspects as per the Figure 4::

- The dead time (T_d) covers the time from the frequency change event until the beginning of the response;
- The step response time (T_{sr}) covers the time from the frequency change event until the instant until the response reaches the tolerance range for the first time;
- The Settling time (T_s) covers the time from the frequency change event until the instant, from where on the corresponding response remains within the tolerance band of the set value.

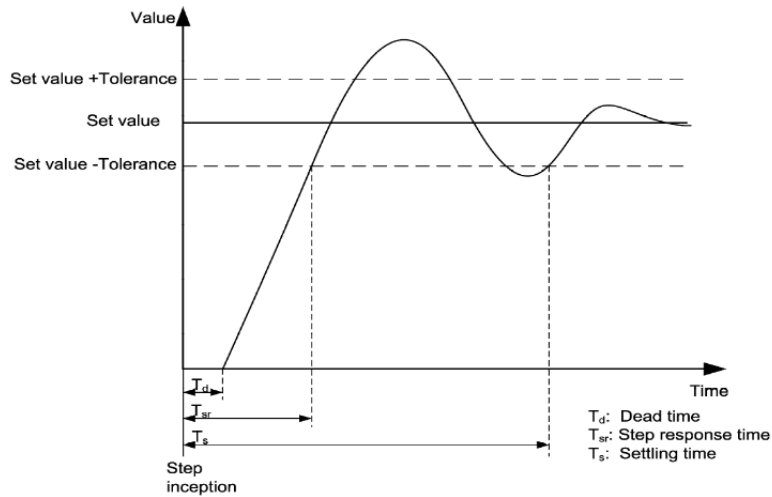

Figure 4: Definition of the PGM response parameters

The below requirements are common for all PGM:

- The droop setting is 5 % and selectable within the range 2% and 12%;
- Frequency activation threshold 50.2 Hz;
- Dead time: by default as fast as technically possible (no intentional delay), specific provisions could be applicable in agreement with the TSO;
- Once the minimum regulating level is reached, the operation mode shall be continued at the same level (no further decrease for further frequency increase).

The droop is defined as per the following formula:

$$s[\%] = 100 \cdot \frac{|\Delta f| - |\Delta f_1|}{f_n} \cdot \frac{P_{ref}}{|\Delta P|}$$

Where ΔP is the change in active power output from the power-generating module. f_n is the nominal frequency (50 Hz) in the network and Δf is the frequency deviation in the network. At overfrequencies where Δf is above Δf_1 , the power-generating module has to provide a negative active power output change according to the droop s .

NC RfG allows two options for defining P_{ref} for power park modules: either P_{max} or the actual active power output at the moment the LFSM threshold is reached. In order to achieve an equitable active power response to a high or low frequency event (regardless of the number of power generating modules in operation) the reference active power P_{ref} is therefore assigned based on the expected capacity operation:

- P_{ref} is by default the actual active (at the moment of activation) for PPM.
- P_{ref} can be alternatively defined as P_{max} for PPM expected to operate mostly at or near maximum capacity (example for offshore wind farms connected to Transmission Network);

For SPGM:

Parameters (SPGM)	For power increase	For power decrease
Step response time	≤ 5 minutes for an increase of active power of 20 % Pmax (a slow reaction is not applicable in the case of an increase shortly –few second- following a decrease phase)	≤ 8 seconds for a decrease of active power of 45% Pmax
Settling time	≤ 6 minutes for an increase of active power (a slow reaction is not applicable in the case of an increase shortly –few second- following a decrease phase)	≤ 30 seconds for a decrease of active power

For PPM:

Parameters (PPM)	For power increase	For power decrease
Step response time	<p><i>For wind generation:</i> ≤ 5 seconds for an increase of active power of 20 % Pmax (at operating points below 50% of maximum power a slower reaction may apply, nonetheless, the response time shall be as fast as technically feasible and not more than 5s)</p> <p><i>For the rest:</i> ≤ 10 seconds for an increase of active power of 50 % Pmax</p>	≤ 2 seconds for a decrease of active power of 50 % Pmax
Settling time	≤ 30 seconds for an increase of active power	≤ 20 seconds for a decrease of active power

3.1.5 Admissible maximum power reduction with falling frequency [Art. 13-4]

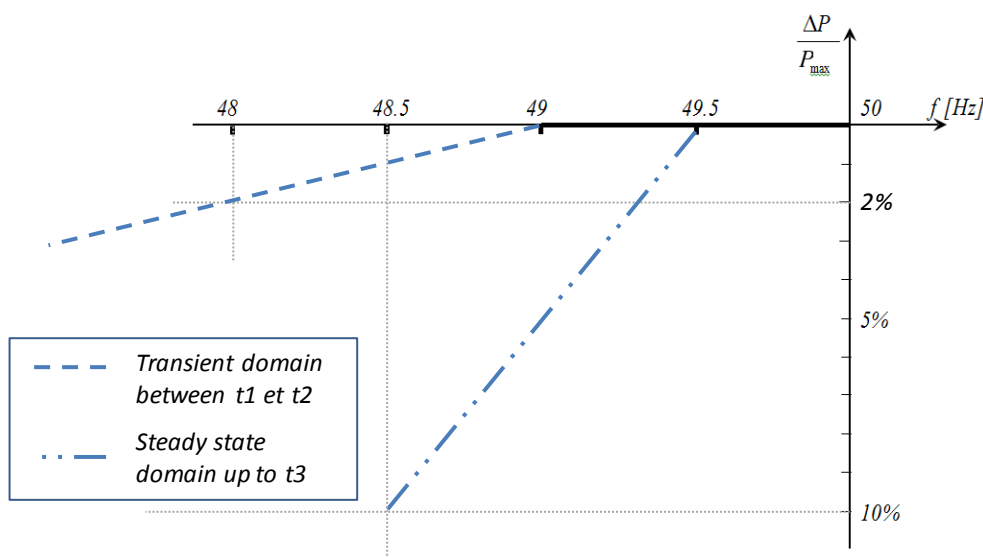

Figure 5 Maximum admissible active power reduction from maximum output for transient and steady state domains

In the case of PPM, no active power reduction is admissible above 49 Hz, below 49 Hz a maximum active power reduction of 2%/Hz is admissible (although it is not expected as PPMs have no specific technology limitation within this range).

In the case of SPGM, in order to take into consideration system needs and technology limitations, two profiles are covering separately transient domain and steady state domain. In case no technical

limitation to maintain active power are existing, active power reduction should be avoided Table 2 covers the requirement during the transient period where the PGM are expected to respect the limit of 2 % active power reduction per Hz from maximum output for a duration up to 30 seconds this would allow other frequency control means to act. During the steady state period, the PGM are allowed if needed to reduce the active power from maximum power output respecting the limit of 10% / Hz.

Table 2 Maximum admissible active power reduction from maximum output requirements

	Parameter	Requirement
Transient domain	Frequency threshold	49 Hz
	Slope	2 % / Hz
	t 1	≤ 2 seconds
	t 2	30 seconds
Steady state domain	Frequency threshold	49.5 Hz
	Slope	10 % / Hz
	t 3	30 minutes

The standard applicable ambient conditions are defined as following:

- Temperature: 25 °C
- Altitude between 400 m and 500 m
- Humidity: between 15 and 20 g H₂O/Kg

Compliance will be based on homologation certification or on a case by case base with the power generator facility owner.

3.1.6 Logical interface to cease active power injection [Art 13-6]

The right to request additional equipment to achieve remote control of the logical interface will be asserted by the relevant system operator in due time.

3.1.7 Automatic connection [Art 13-7]

Automatic connection is allowed for all Units of Type A and for units of Type B for which the RSO is the DSO or the CDSO (insofar the CDSO has not introduced separate or diverging NC RfG Requirements of General Application) providing the following conditions are satisfied:

1. Frequency to be within 49.9 Hz and 50.1 Hz; and
2. Voltage to be within 0.85 Un and 1.10 Un; and
3. Minimum observation time where the above conditions are satisfied of 60 seconds

Following connection adjustable limitation of the gradient of active power increase ≤ 20 % of Pmax/minutes is applicable to be fixed as per operational requirement.

When automatically reconnecting following a network disturbance, the maximum admissible gradient in active power output is 10% of Pmax/min.

For other types (Type B connected to transmission system, Type C), automatic connection is subject to individual authorization to be fixed in their individual connection contracts.

4 Type B Requirements

In addition to the requirements for type A, the following is requested.

4.1 Frequency stability and active power management

4.1.1 Remote control reduction of active power [Art 14 -2]

The right to request additional equipment to allow active power to be remotely operated will be asserted by the relevant system operator in due time.

4.1.2 Automatic reconnection [Art 14-4 (a-b)]

As referred in 14-4 (a) the conditions under which the PGM is capable of reconnecting are defined as following:

1. Frequency within 49.9 Hz and 50.1 Hz; and
2. Voltage within $0.90 U_n$ and $1.10 U_n$; and
3. Minimum observation time where the above conditions are satisfied of 60 seconds
4. When reconnecting after a disconnection caused by a network disturbance, a maximum ramping of 10 % P_{max} per minute is allowed.

For PGM units of Types B, C and D for which the TSO is the RSO, installation and operation of automatic reconnection are prohibited and subject to authorization in their individual connection contracts on a case by case level. For PGMs of Type B for which the DSO or the CDSO (insofar the CDSO has not introduced separate or diverging NC RfG Requirements of General Application) is the RSO, the automatic reconnection is allowed as per the defined conditions.

4.2 Instrumentation [Art 14-5]

4.2.1 Structural data: control and electrical protection schemes and settings [Art 14-5 (a + b)]

This requirement is a site specific one: it is to be agreed during the connection process with the relevant system operator (he might be the (C)DSO or Elia) on a case by case level and fixed in the individual connection contract.

4.2.2 Information exchanges [Art 14-5(d)]

4.2.2.1 Real-time measurements

Requirements :

PGM Type B connected to TSO , DSO and CDSO (insofar the CDSO has not introduced separate or diverging NC RfG Requirements of General Application):

- position of the circuit breakers at the connection point (or another point of interaction agreed with the TSO/DSO);
- active and reactive power at the connection point (or another point of interaction agreed with the TSO/DSO); and
- net active and reactive power of power generating facility in the case of power generating facility with consumption other than auxiliary consumption.

In case of technical infeasibility to communicate this information, gross active and reactive power of power generating facility could be accepted but it has to be agreed during the connection process with the relevant system operator (it might be the (C)DSO or TSO) on a case by case level and fixed in the individual connection contract.

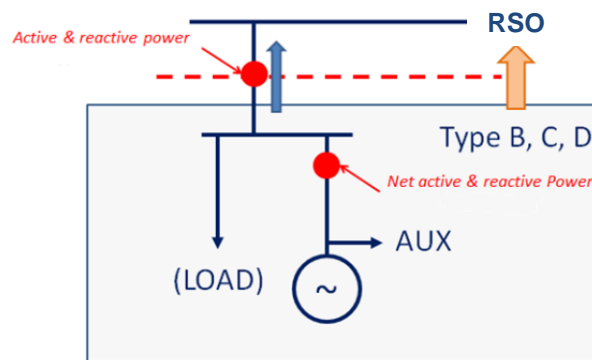

Figure 6: Clarification of the concept of net and gross measurement.

Real-time measurement is defined as a measurement (representation of the current state of a facility) that is refreshed at a rate higher (faster frequency of refreshing) than one minute.

For data related to automatic load-frequency control processes & flexible generation, it shall not be longer than 10 s.

For other purposes, it shall be as fast as possible and, in any case, not longer than one minute.

Note that other real-time measurements could be required by the relevant system operator(s) depending on the location of the PGM, type of prime mover and the availability of measurements.

During the connection procedure of the unit, the exact list of signals to exchange, the communication protocols and infrastructure requirements are communicated by the relevant system operator³.

³ As communication standard can change over time, ELIA will make available over time the specifications of the communication protocols on its website.

4.3 Type B – SPGM Requirements

4.3.1 Reactive power capabilities - SPGM [Art 17-2(a)]

The required reactive capabilities should be met at the HV side of the SPGM step up transformer if existing; otherwise it should be met at the alternator terminals.

The requirements apply to SPGM connected to TSO, public DSO and CDSO (insofar the CDSO has not introduced separate or diverging NC RfG Requirements of General Application).

For SPGMs of type B, the requirement for the reactive power provision capability is determined by the Q/P profile represented in Figure 7 where the limitations are based on nominal current at high active power output and by a reactive power (Q) limited to -33% and +33% of P_D , where P_D is the maximum active power that can be produced in case of the maximum requested reactive power output (hence equal to $0.95 \cdot S_{nom}$).

With respect to voltages different from $1pu^4$, the required U/U_c -Q/ P_D profile is represented in Figure 8.

Note that the effective resulting available capability of the SPGM at the connection point (that might be different than the one at the SPGM terminals) should be communicated, demonstrated and put at disposal of the relevant system operator during the connection procedure.

The owner of the SPGM is not allowed to refuse the use of the reactive capability without a technical justification. The unit is therefore expected to not limit its capabilities to comply with the minimum requirement but to use the full capability to support the system stability as stated in its agreement.

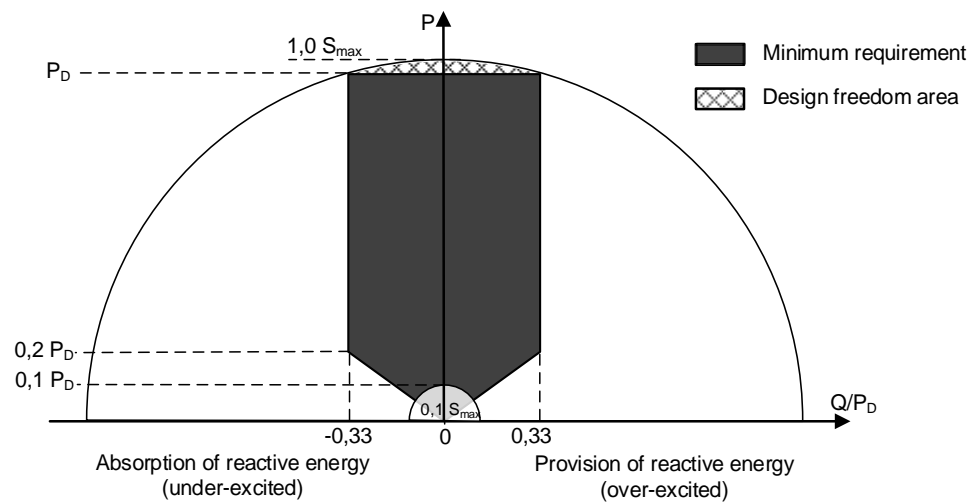

Figure 7: Capability curve for SPGM type B

⁴ The nominal values of voltages are defined in §2.1.1.

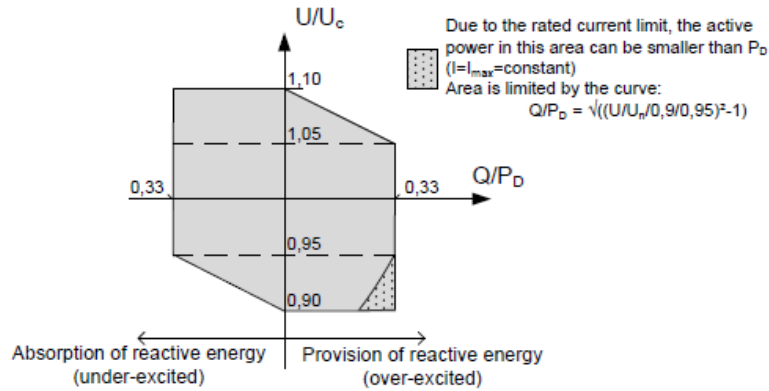

Figure 8: U/Uc-Q/PD profile for type B SPGM in order to visualize reactive power requirements for voltages different from 1pu.

4.3.2 Voltage Control SPGM type B [Art 17-2 (b)]

With regards to the voltage control system, a synchronous power-generating module (SPGM) of type B shall be equipped with a permanent automatic excitation control system that can provide constant alternator terminal voltage at a remotely selectable setpoint without instability over the entire operating range of the synchronous power-generating module. This means that this SPGM shall be capable to control voltage with 2 control modi:

- Qfix: maintain a constant reactive power within the P/Q capabilities of Figure 7.
- Q(U): maintain a constant alternator voltage within the P/Q capabilities of Figure 7.
- For all those control modes the setpoint should be remotely selectable.

Note: Other reactive power control modi that are needed for local distribution management may be requested by the DSO and CDSO (insofar the CDSO has not introduced separate or diverging NC RfG Requirements of General Application).

4.3.3 Fault-ride through for symmetrical and asymmetrical faults for SPGM [Art 14-3]

This requirement should be met at the connection point.

The SPGM should be able to support the network during fast transient voltages and network short-circuits for which the profile of the voltage versus time is referred as Fault-Ride-Through (FRT). SPGM shall fulfil the requirements in the figure below, where the SPGM shall remain connected to the grid as long as the voltage of the phase having the lower voltage is above the profile.

It is recommended however to remain connected as long as the technical capability of the PGM would allow. The same profile applies for asymmetrical faults.

The proposed Fault-Ride-Through parameters are presented in the figure below.

A voltage $U=1 \text{ pu}^5$ represents the rated voltage (phase-to-phase) at the connection point.

⁵ The nominal values of voltages are defined in §2.1.1.

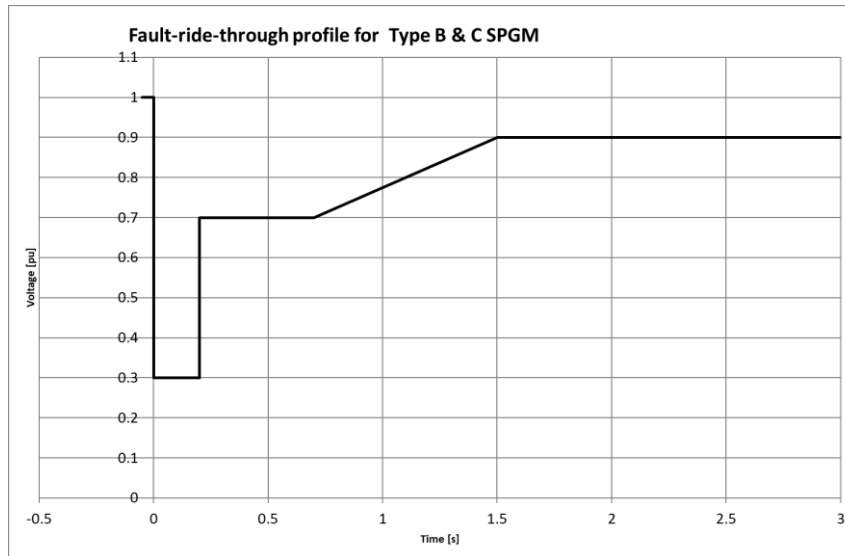

Figure 9: FRT requirement for SPGM type B and C

Table 3 : Parameters of the FRT requirements for SPGM of type B and C.

Voltage parameters [pu]	Time parameters [seconds]
$U_{ret} = 0.3$	$t_{clear} = 0.2$
$U_{clear} = 0.7$	$t_{rec1} = t_{clear}$
$U_{rec1} = 0.7$	$t_{rec2} = 0.7$
$U_{rec2} = 0.9$	$t_{rec3} = 1.5$

The parameters considered for Fault-Ride-Through capability calculations (e.g. pre and post fault short circuit capacity, pre-fault operating point of the SPGM...) are communicated by the TSO on request of the power-generating facility owner during the connection process.

For DSO connected units, by default the compliance will be assessed via certification.

According to Art 14 3. (a) (vii), the relevant system operator can specify narrower settings for minimum voltage protection.

4.3.4 Post-fault active power recovery - SPGM [Art 17-3]

It is required that SPGM of Type B are able to provide post-fault active power recovery.

For distribution connected SPGMs of type B for which the public DSO or CDSO (insofar the CDSO has not introduced separate or diverging NC RfG Requirements of General Application) is the relevant system operator, the proposed default post fault active power recovery requirement is 90% of pre-fault power within 3 seconds. Another site specific requirement is to be agreed during the connection process with the DSO in coordination with the TSO.

For all other SPGMs, the values of the magnitude and time for the active power recovery will be a site specific specification: it is to be agreed during the connection process with the TSO on a case by case level and fixed in the individual connection contract.

4.4 Type B – PPM Requirements

4.4.1 Fault-ride through for symmetrical and asymmetrical faults - PPM [Art 14.3]

This requirement should be met at the connection point.

The PPM unit should be able to support the network during fast transient voltages and network short-circuits for which the profile of the voltage versus time is referred as Fault-Ride-Through (FRT). PPM shall fulfil the requirements in Figure 10 (the evolution of the minimum voltage at the Connection Point), where the PPM shall remain connected to the grid as long as the voltage of the phase having the lower voltage is above the profile of Figure 10. It is recommended however to remain connected as long as the technical capability of the PPM would allow it. The same profile applies for asymmetrical faults.

The proposed fault-ride-through parameters are presented in Table 4.

A voltage $U=1 \text{ pu}^6$ represents the rated voltage (phase-to-phase) at the connection point.

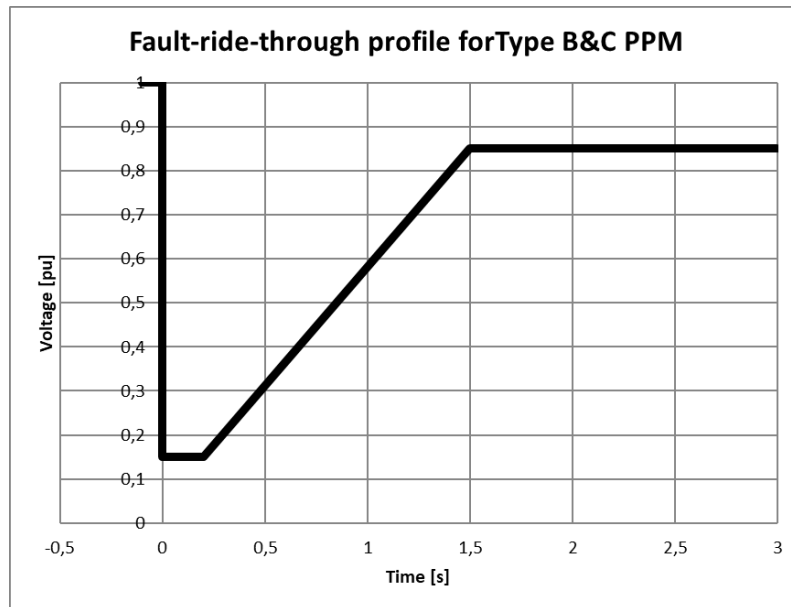

Figure 10: FRT requirement for PPM type B and C

Table 4 : Parameters of the FRT requirements for PPM of type B and C.

Voltage parameters [pu]	Time parameters [seconds]
$U_{ret}=U_{clear}=U_{ret1}= 0.15$	$t_{clear}=t_{rec1}=t_{rec2}= 0.2$
$U_{rec2} = 0.85$	$t_{rec3}=1.5$

According to Art 14 3. (a) (vii), the relevant system operator can specify narrower settings for minimum voltage protection..

4.4.2 Reactive capabilities - PPM [Art 20-2(a)]

The required reactive capabilities should be met at the HV side of the step up transformer if existing; otherwise they should be met at the inverter terminals.

For PPMs of type B, the requirement for the reactive power provision capability is determined by the Q-P profile represented in Figure 11 where the limitations are based on nominal current at high active power output and by a power factor ($\cos(\phi)$) defined by the 2 points at $Q= -33\%$ and $+33\%$ of P_D ,

⁶ The nominal values of voltages are defined in §2.1.1.

where P_D is the maximum active power that can be produced in case of the maximum requested reactive power output (hence equal to $0.95 \cdot S_{nom}$).

With respect to voltages different from 1pu, the required U/U_c - Q/P_D profile is represented in Figure 12.

Note that the effective resulting available capability of the PPM at the *connection point* (that can be different than the one at the PPM terminal) should be communicated, demonstrated and put at disposal of the relevant system operator during the connection procedure.

The owner of the PPM is not allowed to refuse the use of the reactive capability without a technical justification. The unit is therefore expected to not limit its capabilities to comply with the minimum requirement but to use the full capability to support the system stability as stated in its agreement.

In case the PPM unit has already the capability of voltage regulation, it should not refuse the relevant system operator to make use of this capability of voltage regulation. In this case, the settings of the controllers should be agreed with the relevant system operator.

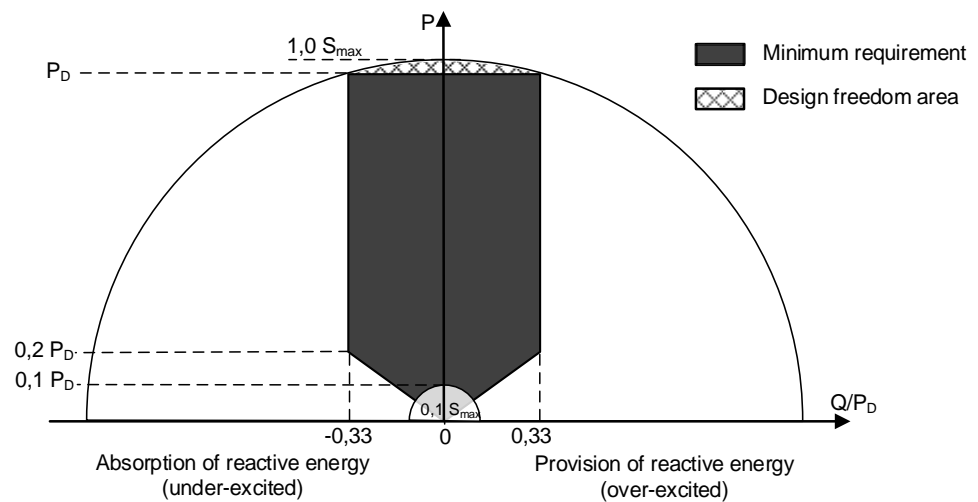

Figure 11: Capability curve for PPM type B

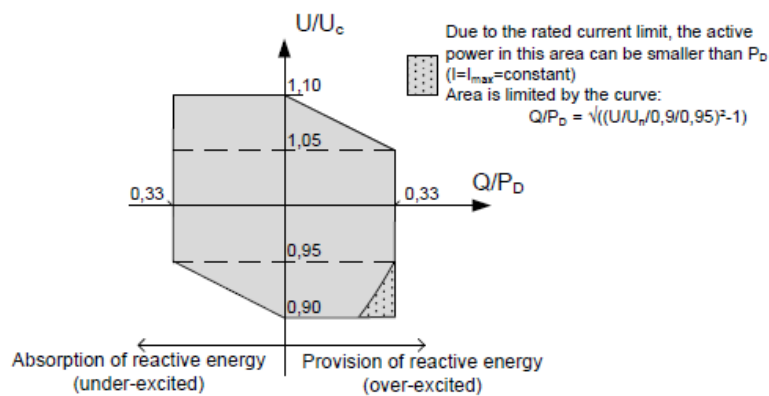

Figure 12: U/U_c - Q/P_D profile for type B PPM in order to visualize reactive power requirements for voltages different from 1pu .

Note: The control modi that are needed for local distribution management may be requested by the DSO.

4.4.3 Fault Current & dynamic voltage support [Art 20-2 (b and c)]

The PPM unit shall be able to inject/absorb additional reactive current compared to the pre-fault state during low and high voltage conditions up to the maximum of its capability.

The additional injected/absorbed reactive current shall be function of the positive sequence voltage at the connection point or point or unit terminals depending on the available capability of the PPM.

The resulting fast current injection at the point of connection should be calculated and shared with the TSO by simulation in terms of active and reactive current components.

The requested additional reactive current characteristic injection is illustrated in Figure 13.

For voltages within the deadband $[\Delta V_-^{act}, \Delta V_+^{act}]$, the PPM unit should follow the normal voltage control mode.

The injection or absorption of additional reactive current shall be delivered by the PPM with a minimal delay from the detection of the over/undervoltage, t_{Iq}^{act} . The functionality should remain active for a minimum time of t_{Iq}^{on} and can be deactivated if the voltage returns and remains within $[\Delta V_-^{act}, \Delta V_+^{act}]$ for a time longer than t_{Iq}^{off} .

The parameters of this functionality lying within the normal operational range of the installation as well as the delays of activation, dead band and duration of the activation are to be agreed during the connection process on a case by case level and fixed in the individual connection contract with the relevant system operator (it might be the CDSO or Elia) in coordination with the relevant TSO. These parameters are thus a site specific requirements.

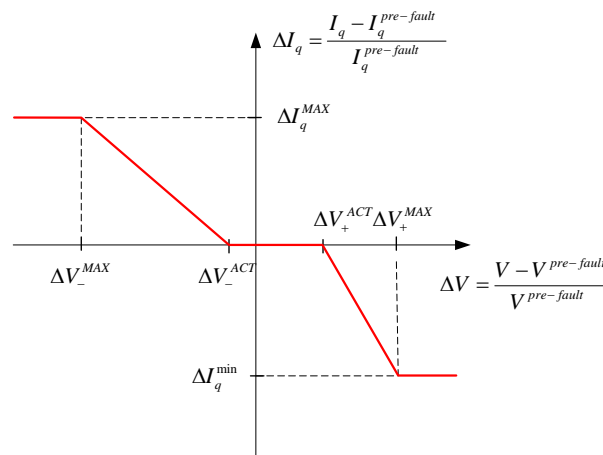

Figure 13: Injection of additional reactive current

For the reliable detection of asymmetric faults, the PPM unit shall contribute to the fault with positive, negative and zero-sequence current. The short-circuit contribution is to be agreed during the connection process on a case by case level and fixed in the individual connection contract with the relevant system operator (it might be the CDSO or Elia) in coordination with the relevant TSO. This parameter is thus a site specific requirement.

For Type B generating units connected to distribution networks, the DSO intends to refer to the requirement in the future European standard EN50549-2.

4.4.4 Post-fault active power recovery [Art 20-3]

For PPMs connected to TSO, the parameters of this functionality and its activation should be agreed during the connection process with the relevant TSO on a case by case approach and fixed in the individual connection contract. These parameters are thus a site specific requirement.

For distribution connected PPMs of type B for which the public DSO or the CDSO (insofar the CDSO has not introduced separate or diverging NC RfG Requirements of General Application) is the relevant system operator, the proposed default post fault active power recovery requirement is 90% of pre-fault power within 1 seconds. Another site specific specification is to be agreed during the connection process with the DSO in coordination with the TSO.

5 Type C Requirements

In addition to the relevant specifications for type B, the following is requested.

5.1 Frequency stability & Active Power management

5.1.1 Active Power Controllability and Control Range [Art. 15-2 (a-b)]

The relevant TSO shall establish the period within which the adjusted active power set point must be reached. The relevant TSO shall specify a tolerance (subject to the availability of the prime mover resource) applying to the new setpoint and the time within which it must be reached as shown in the figure below.

The minimum period to reach the active power setpoint would be defined in the connection contract as per the technical ramping capabilities. Therefore, dependent on the technology, it is agreed during the connection process on a case by case level and fixed in the individual connection contract with the relevant system operator. These parameters are a site specific requirement.

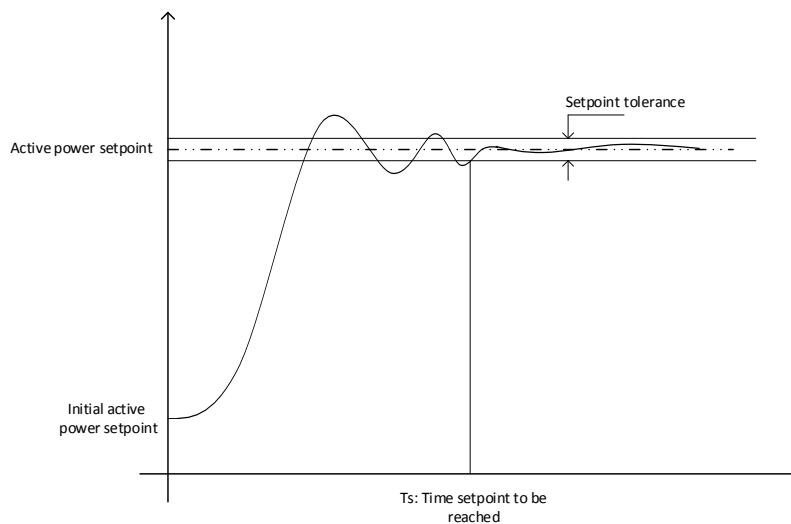

Figure 14 : Tolerance and time duration for application of new set point of active power

With respect to local measures where the automatic remote device is out of service, the minimum time for the setpoint to be reached is equal to 15 minutes for a tolerance of 10% of the active power setpoint.

5.1.2 Limited frequency sensitive mode – under frequency (LFSM-U) [Art. 15-2 (c)]

Similarly to the LFSM-O requirements, in order to take into consideration the system transient behaviour and the need for an adequate frequency response reaction, the proposal addresses as well the response performance while taking into consideration different PGM technologies. The delivery of the active power frequency is subject to the aspects covered in the paragraph 15 (2) (c) ii.

The below requirements are common for all PGM:

- The drop setting is 5 % and selectable within the range 2% and 12%;
- Frequency activation threshold 49.8 Hz;
- Dead time: as fast as technically possible, no intentional delay is foreseen.

The droop is defined as per the following formula:

$$s[\%] = 100 \cdot \frac{|\Delta f| - |\Delta f_1|}{f_n} \cdot \frac{P_{ref}}{|\Delta P|}$$

Where ΔP is the change in active power output from the power-generating module. f_n is the nominal frequency (50 Hz) in the network and Δf is the frequency deviation in the network. At underfrequencies where Δf is below Δf_1 the power-generating module has to provide a positive active power output change according to the droop s .

NC RfG allows for two options for defining P_{ref} for power park modules: either P_{max} or the actual active power output at the moment the LFSM threshold is reached. In order to achieve an equitable active power response to a high or low frequency event (regardless of the number of power generating modules in operation) the reference active power P_{ref} is therefore assigned:

- P_{ref} is by default the actual active (at the moment of activation) for PPM.
- P_{ref} can be alternatively defined as P_{max} for PPM expected to operate mostly at or near maximum capacity (example for offshore wind farms connected to Transmission Network);

For SPGM:

Parameters (SPGM)	For power increase	For power decrease
Step response time	≤ 5 minutes for an increase of active power of 20 % P_{max} (a slow reaction is not applicable in the case of an increase shortly –few second- following a decrease phase)	≤ 8 seconds for a decrease of active power of 45% P_{max}
Settling time	≤ 6 minutes for an increase of active power (a slow reaction is not applicable in the case of an increase shortly –few second- following a decrease phase)	≤ 30 seconds for a decrease of active power

For PPM:

Parameters (PPM)	For power increase	For power decrease
Step response time	<p><i>For wind generation:</i> ≤ 5 seconds for an increase of active power of 20 % P_{max} (at operating points below 50% of maximum power a slower reaction may apply, nonetheless, the response time shall be as fast as technically feasible and not slower than > 5s)</p> <p><i>For the rest:</i> ≤ 10 seconds for an increase of active power of 50 % P_{max}</p>	≤ 2 seconds for a decrease of active power of 50 % P_{max}
Settling time	≤ 30 seconds for an increase of active power	≤ 20 seconds for a decrease of active power

5.1.3 Frequency Sensitive Mode [Art. 15.2.d]

The setting parameters for the frequency sensitive mode are summarized in below:

Parameters	Values and ranges
Active power range $ \Delta P_1 /P_{max}$	A range between 2% and 10%
Frequency response insensitivity	$ \Delta f $ Maximum 10 mHz
	$ \Delta f /f_n$ Maximum 0,02 %
Frequency response deadband	0 mHz and adjustable between 0 et 500 mHz (a combined response insensitivity, possible delay and response dead band shall be limited to 10 mHz)
Droop s_1	Adjustable between 2% and 12% to guaranty a full activation $ \Delta P_1 /P_{max}$ for the maximum frequency activation (200 mHz)
P_{ref}	Defined as P_{max} for SPGM Defined as actual Active Power output when FSM threshold is reached or P_{max} in alignment with the provisions fixed for LFSM-O and LFSM-U.

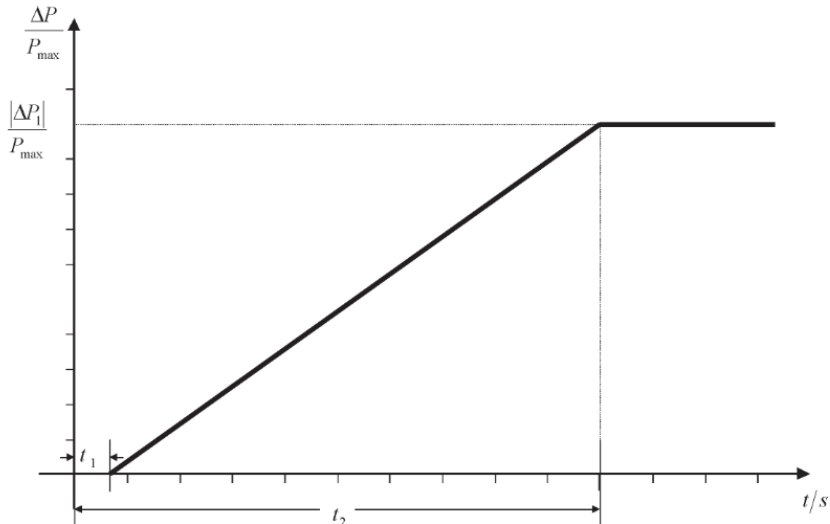

Figure 15 Active power response capability

With respect to the paragraph 15.2.(d).iii, the requirements in term of time response characteristics as described in the Figure 4 are defined as below:

- t_1 : Maximum 2 seconds for PGM with inherent inertia and Maximum 500 milliseconds for PGM without inherent inertia
- t_2 : Maximum 30 seconds (15 seconds for 50% of full active power activation)
- full activation duration: minimum 15 minutes

5.1.4 Frequency restoration control [Art 15-2.e]

Specifications aligned with synchronous area TSOs in compliance with the System Operation Guidelines (Articles 154, 158, 161, 165) [8] and currently applicable requirement of Elia, are to be agreed during the connection process with the relevant system operator (it might be the (C)DSO or Elia) on a case by case level and fixed in the individual connection contract.

5.1.5 Real-time monitoring of FSM [Art 15-2.g]

Defined coherently as per the System Operation Guidelines (Article 47) [8] and currently applicable requirement of Elia are to be agreed during the connection process with the relevant system operator (it might be the (C)DSO or Elia) on a case by case level and fixed in the individual connection contract.

5.1.6 Automatic disconnection for voltage outside ranges [Art 15-3]

The automatic disconnection due to voltage outside ranges is not requested in a generic manner. This requirement is considered site specific. The activation, values and settings of this functionality should be agreed during the connection process by the relevant system operator in coordination with the relevant TSO on a case by case level and fixed in the individual connection contract with the relevant system operator. The grid user will have to validate the settings of the disconnection relays with the relevant TSO. Automatic reconnection to the network after a disconnection is not allowed and should be coordinated with the relevant TSO.

5.1.7 Rates of change of active power output [Art 15-6(e)]

Minimum and maximum active power ramping limits (upward and downward) should be agreed during the connection process by the relevant system operator in coordination with the relevant TSO on a case by case level and fixed in the individual connection contract with the relevant system operator.

The ramping limits are to be defined site specifically taking into consideration the prime mover technology in compliance the System Operation Guidelines [8]. These limits are to be defined by the relevant system operator in coordination with the TSO.

5.2 System restoration [Art 15-5]

Different from the current Federal Grid Code [4], the NC RfG asks for more strict behaviour for system restoration.

5.2.1 Capability to take part in island operation [Art 15.5(b)]

The PGMs of type C are not required to take part to island operation. Nevertheless they are required to be able to trip to houseload and be able to quick-resynchronize as specified in 15-5(c).

5.2.2 Quick resynchronization capability [Art 15-5(c)]

More specifically with regard to quick re-synchronisation capability:

- i. In case of disconnection of the power-generating module from the network, the power-generating module shall be capable of quick re-synchronization in line with the protection strategy agreed between the relevant system operator in coordination with the relevant TSO and the power-generating facility.
The quick re-synchronization strategy is to be agreed with the relevant TSO on a case by case basis.
- ii. A power-generating module with a minimum re-synchronization time greater than 15 minutes after its disconnection from any external power supply must be designed to trip to houseload from any operating point in its P-Q-capability diagram. In this case, the identification of houseload operation must not be based solely on the system operator's switchgear position signals.
The strategy of identification of houseload operation is to be agreed with the relevant TSO on a case by case basis.
- iii. Power-generating modules shall be capable of continuing operation following tripping to houseload, irrespective of any auxiliary connection to the external network. The minimum operation time shall be specified by the relevant system operator in coordination with the relevant TSO, taking into consideration the specific characteristics of prime mover technology.
For PGMs connected to TSO network, the minimum operation time is to be defined during the connection process.

5.3 Instrumentation, simulation and protection

5.3.1 Loss of angular stability or loss of control [Art 15.6(a)]

The power generating facility owner and the relevant system operator in coordination with the TSO shall agree during the connection process about the criteria to detect loss of angular stability or loss of control and consequent disconnection of the unit. These parameters will be taken in the appendices of the individual connection agreement.

5.3.2 Instrumentation [Art 15.6(b)]

The quality of supply parameters, the triggers for activation of fault recorders and power oscillation and relative sampling rates and the modality of access to the recorded data is to be defined in agreement with the TSO and/or relevant system operator (in accordance with art 15-6) during the connection process. These parameters will be taken in the appendices of the individual connection agreement.

5.3.3 Simulation models [Art 15.6(c)]

Simulation models able to reflect the behaviour of the power generating module in steady state and electromechanical dynamic simulation (phasor-based) are required by ELIA for all units. A model to represent Electro Magnetic Transient phenomena can be required on a site specific base for every concerned unit.

The format of the model, as well the provision of documentation and short circuit capacity should be coordinated by the relevant system operator with the TSO during the connection process. These parameters will be taken in the appendices of the individual connection agreement.

5.3.4 Devices for system operation and security [Art 15.6(d)]

The installation of additional devices for system operation and security should be agreed between the RSO or TSO and the PGFO on a site specific base.

5.3.5 Earthing of the neutral point at the network side of the step-up transformer [Art 15.6(f)]

The relevant system operator shall specify the earthing arrangement of the neutral-point at the network side of step-up transformers during connection process. These parameters will be taken in the appendices of the individual connection agreement.

5.4 Voltage control mode (for SPGM and PPM) [Art 19-2(a) and Art 21.3(d)]

This requirement should be met at the connection point.

By default the control mode is a voltage droop/slope mode. However site specific (during the grid conformity process with the relevant system operator and connection process) a different control mode can be requested/agreed.

These specifications are given in line with the 2002 FGC Art. 69. The power generating modules of types C and D are considered regulating units. They must be able to adapt their reactive power injected at the *connection point*:

- Automatically in case of slow or fast variations of the grid voltage. This has to happen according to a reactive droop (FGC Art. 73);
- Through change of the controller setpoint on request of the Transmission System Operator. This request is quantified in Mvar measured at the connection point. The change of setpoint shall be initiated immediately after reception of the request;
- Reactive power exchange with the TSO network to control the voltage covering at least the 0.90 to 1.10 pu voltage range should be in steps not greater than 0.01 pu;
- The reactive power output shall be zero when the grid voltage value at the connection point equals the voltage setpoint.

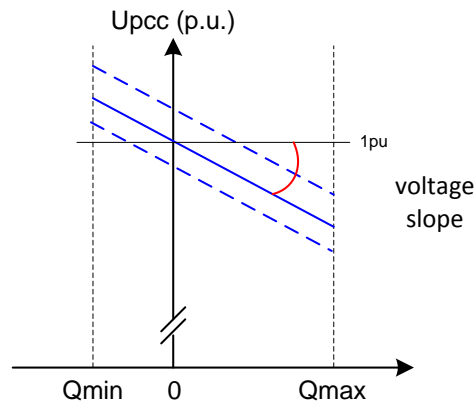

Figure 16 : Principle of the voltage and reactive power control

Automatic voltage control has to fulfil a reactive droop requirement (Figure 16). On request of the Transmission System Operator, the setpoint of the controller can be modified in real-time, and the operating point is to be shifted to a parallel line (dashed) with the same slope (illustrated in Figure 16). The control loop gain will be agreed between the Transmission System Operator and the PGM operator (before first energization) so that α_{eq} lies between 18 and 25, as expressed in the following:

$$\alpha_{eq} = - \frac{\left(\frac{\Delta Q_{net}}{0,45 \times P_{nom}} \right)}{\left(\frac{\Delta U_{net}}{U_{norm,exp}} \right)}$$

Where

- U_{net} is the voltage measured at the Connection Point
- $U_{norm,exp}$ is the normal exploitation voltage at the Connection Point
- Q_{net} is the injected reactive power measured at the Connection Point

The α_{eq} values can be transformed and are hence totally in line the value of a slope having a range of at least 2 to 7% as is mentioned in RfG art. 21.3d(ii).

5.5 Type C SPGM Requirements

5.5.1 Reactive power capability SPGMs [Art 18-2]

This requirement should be met at the connection point.

All SPGMs of type C (and type D) should be compliant with the requested reactive power capabilities of the U-Q/P_{max} diagram in Figure 17. For every connection demand, it should be proven that the SPGM is able to operate within the range shown in the figure below. The maximum voltage value of 1.10pu should be considered as 1.05pu in case of connection to voltage level above 300kV.

Note that the available capability of the SPGM (which could be wider than the minimum requirement) should be communicated, demonstrated and put at disposal of the relevant system operator.

The owner of the SPGM is not allowed to refuse the use of the reactive capability without a technical justification. The unit is therefore expected to not limit its capabilities to comply with the minimum requirement but to use the full capability to support the system stability as stated in its agreement.

The SPGM should be in state to deliver the reactive capacity shown in figure above for the whole operating range of active power, conform to art 18.2(c).

The speed of reaction within the capability curve is site specific and will be determined during the connection conformity process (e.g. EDS) and specified in the contractual agreement.

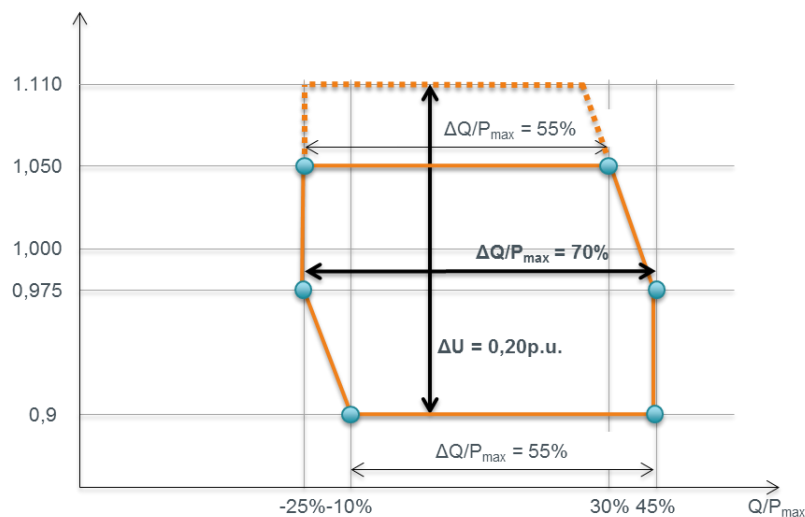

Figure 17: Capability curve for SPGM type C and D.

5.5.2 Voltage control requirements for SPGM type C

The proposed requirements for voltage control for type C units are in line with the 2002 federal grid code (Art. 75) [4] for which regards the functionalities and parameter settings of the automatic voltage regulator with regard to steady-state voltage and transient voltage control and the specifications and performance of the excitation control system. The functionality shall include:

- bandwidth limitation of the output signal to ensure that the highest frequency of response cannot excite torsional oscillations on other power-generating modules connected to the network;
- an underexcitation limiter to prevent the AVR from reducing the alternator excitation to a level which would endanger synchronous stability;
- an overexcitation limiter to ensure that the alternator excitation is not limited to less than the maximum value that can be achieved whilst ensuring that the synchronous power-generating module is operating within its design limits;
- a stator current limiter;
- a Power System Stabilizer (PSS) function to attenuate power oscillations, requested by the relevant TSO (i.e. the activation and tuning of the PSS function will be agreed depending on the connection point, size and the characteristic of the SPGM).

5.6 Type C PPM Requirements

5.6.1 Synthetic inertia for PPM [Art 21-2]

Synthetic inertia functionality is not required in the current General Requirements.

5.6.2 Reactive capabilities - PPM [Art 21-3(a-c)]

This requirement should be met at the connection point.

A PPM of type C shall be capable to deliver reactive power within the Q-P profile described in Figure 18.

For every voltage at the Connection Point between 90 % and 110 % of U_{nom} and for any value of the active power output between P_{min} (0.2 p.u. of P_{nom}) and P_{nom} , the PPM shall be able to produce or consume - at least - any reactive power at the connection point within the area limited by Q1,Q2,Q3 and Q4 (Figure 18).

This range has an obligated minimum span of 0.6 p.u. of P_{nom} , but can move within an area of $[-0.3$ p.u. of P_{nom} , $+0.35$ p.u. of $P_{nom}]$ when accepted by ELIA, based on the connection point, size and the characteristic of the installation.

For all values between the 90% and the 110% for nominal voltage below 300kV (or 90% and 105% for nominal voltage above 300kV) voltage ranges, it is requested that the PPM could participate in voltage regulation at least in the above mentioned reactive power range (as is represented in the U-Q/Pmax profile in Figure 19) ; for values outside of the 90% and the 110% for nominal voltage below 300kV (or 90% and 105% for nominal voltage above 300kV) voltage ranges, it is requested that the PPM could participate in voltage regulation to the maximum of the technical capabilities of the installation.

For every voltage value, at the Connection Point, between 90 % and 110% of U_{nom} for nominal voltage below 300kV (or 90% and 105% for nominal voltage above 300kV) and for any value of active power output between P_0 (equal to 0.0263 p.u. of P_{nom}) and P_{min} , the minimum range of operating point for which reactive power shall be controlled is defined by the two values of the power factor computed by the points (Q1,0.2* P_{nom}) and (Q2, 0.2* P_{nom}).

For every voltage, at the Connection Point, between 90 % and 110 % of U_{nom} for nominal voltage below 300kV (or 90% and 105% for nominal voltage above 300kV) and for any value of active power output below P_0 , the reactive power can be uncontrolled, however, injected/absorbed values must be limited within a range of $Q = [-0.0329 ; +0.0329]$ p.u. of P_{nom} ⁷ that is represented by the shaded area in the Figure 18.

For specific voltages at the connection point, the required reactive power capabilities are smaller as represented in the U-Q/Pmax characteristic of Figure 19 .

In case of non-availability of units within the PPM due to failure or maintenance- the reactive power capability might be adjusted based on the current Available Generation Capacity P_{av} instead of P_{nom} (1. P.u as per the figure below) which is expressed as following:

$$P_{av} = \sum_{i=1}^N av_i \times P_i$$

Where:

N is the number of installed units in the PPM

av_i is the availability factor of a unit i (either 0 or 1)

P_i is the production capacity of a unit i during the failure or maintenance.

⁷ FGC Article 209 §3: 3,29 % = 10 % of the reactive range at $\cos(\phi) = 0.95$.

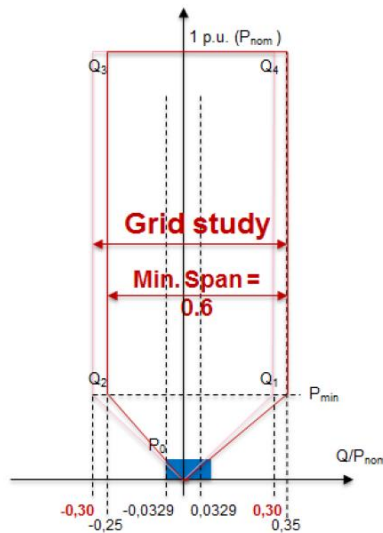

Figure 18: Reactive power capability for a Type C and D PPM.

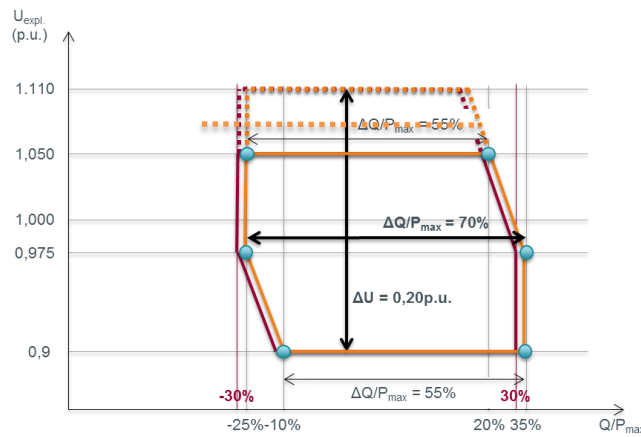

Figure 19: U-Q/Pmax profile for a type C PPM (dashed for nominal voltages above 300kV).

Note that the available capability of the PPM (which could be wider than the minimum requirement) should be communicated, demonstrated and put at disposal of the relevant system operator.

The owner of the PPM is not allowed to refuse the use of the reactive capability without a technical justification. The unit is therefore expected to not limit its capabilities to comply with the minimum requirement but to use the full capability to support the system stability as stated in its agreement.

The speed of reaction within the capability curve is site specific and will be determined during the connection conformity process (e.g. EDS) and specified in the contractual agreement.

5.6.3 Voltage control - PPM [Art 21-3 (d) and (e)]

This requirement should be met at the connection point.

The PPM shall be capable of providing reactive power automatically by either voltage control mode, reactive power control mode or power factor control mode.

The requirement for the prioritizing of active or reactive power contribution is to be defined as site specific by the relevant system operator. It has to be agreed during the connection process with the relevant system operator in coordination with the relevant TSO on a case to case basis and fixed in the individual connection contract with the relevant system operator.

6 Type D Requirements

In addition to the relevant specifications for type C, the following is requested.

6.1 Voltage Control

6.1.1 Voltage withstand capability [Art 16-2(a & b)]

This requirement should be met at the connection point.

Beside the requirements mentioned in paragraph 2.1.1, the required voltage withstand capabilities for type D SPGMs should follow the requirements as described in the EU NC RfG art. 16.2:

	Voltage Range	Time period for operation
Voltage ranges below 300kV	0.85 pu – 0.90 pu	60 minutes
	0.90 pu – 1.118 pu	Unlimited
	1.118 pu – 1.15 pu	20 minutes
Voltage ranges above 300kV	0.85 pu – 0.90 pu	60 minutes
	0.90 pu – 1.05 pu	Unlimited
	1.05 pu – 1.10 pu	20 minutes

The following base values are to be considered for PGM connected to TSO network:

- 400kV
- 220kV
- 150kV
- 110kV
- 70kV
- 36kV

In case of broader or longer voltage withstand capabilities technically and economically feasible, the owner of the installation should put this at disposal of the relevant system operator.

6.1.2 Automatic disconnection for voltage outside ranges [Art 16-2(c)]

No automatic disconnection is foreseen as a generic requirement.

The terms and settings for automatic disconnection should be agreed during the connection process with the PGFP by the relevant system operator in coordination with the relevant TSO on a case by case basis and fixed in the individual connection contract with the relevant system operator.

6.2 Resynchronization [Art 16-4]

The relevant system operator and the PFGO should agree on the settings of the synchronization devices during the connection process on a case by case basis and fixed in the individual connection contract with the relevant system operator.

6.3 Type D SPGM Requirements

6.3.1 Fault-ride through for symmetrical and asymmetrical faults – SPGM [Art 16-3]

This requirement should be met at the connection point.

The SPGM unit should be able to support the network during fast transient voltages and network short-circuits for which the profile of the voltage versus time is referred as Fault-Ride-Through (FRT). SPGM unit shall fulfil the requirements in the Figure below (the evolution of the minimum voltage at the Connection Point), where the SPGM shall remain connected to the grid as long as the voltage of the phase having the lower voltage is above the profile shown in the Figure below.

It is recommended however to remain connected as long as the technical capability of the SPGM would allow. The same profile applies for asymmetrical faults.

The proposed fault-ride-through parameters⁸ following FRT are presented in the table below
A voltage $U=1$ pu represents the rated voltage (phase-to-phase) at the connection point.

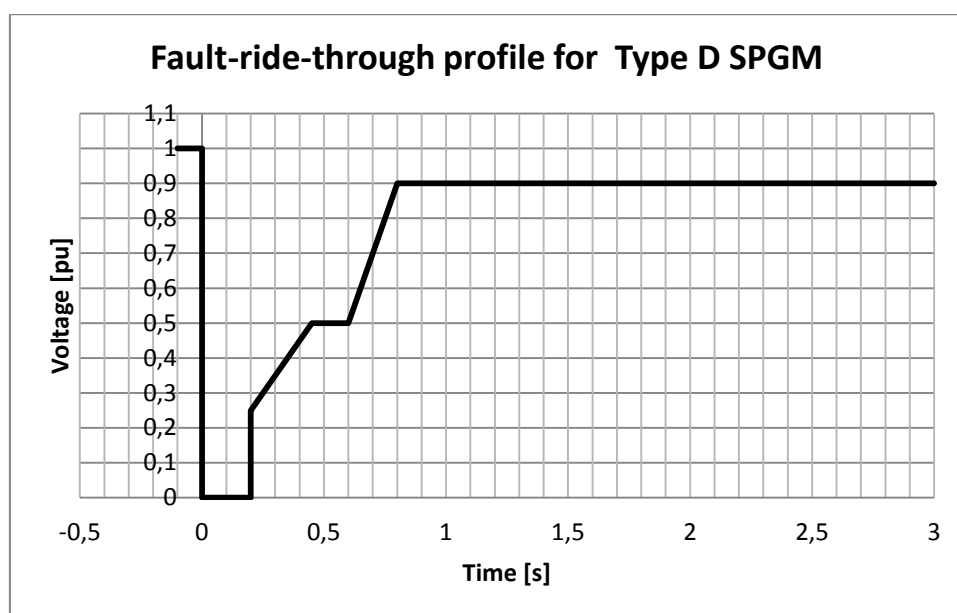

Figure 20 :FRT requirement for SPGM type D

Table 5 : Parameters of the FRT requirements for SPGM of type D

Voltage parameters [pu]	Time parameters [seconds]
$U_{ret} = 0$	$t_{clear} = 0.2$
$U_{clear} = 0.25$	$t_{rec1} = 0.45$
$U_{rec1} = 0.5$	$t_{rec2} = 0.6$
$U_{rec2} = 0.9$	$t_{rec3} = 0.8$

The parameters considered for fault-ride through capability calculations (e.g. pre and post fault short circuit capacity, pre-fault operating point of the PGM...) are communicated by the TSO on request of the power-generating facility owner during the connection process.

⁸ Note that the parameter are not the coordinates of the FRT curve but must be interpreted following the specification of the RfG, art. 14.3 and presented, for information, in appendix I.

6.3.2 Voltage stability SPGM [Art 19-2]

In line with the 2002 federal grid code (art 75) [4] for which regards the functionalities and parameter settings of the automatic voltage regulator with regards to steady-state voltage and transient voltage control and the specifications and performance of the excitation control system. The latter shall include:

- i. bandwidth limitation of the output signal to ensure that the highest frequency of response cannot excite torsional oscillations on other power-generating modules connected to the network;
- ii. an underexcitation limiter to prevent the AVR from reducing the alternator excitation to a level which would endanger synchronous stability;
- iii. an overexcitation limiter to ensure that the alternator excitation is not limited to less than the maximum value that can be achieved whilst ensuring that the synchronous power-generating module is operating within its design limits;
- iv. a stator current limiter; and
- v. a PSS function to attenuate power oscillations, requested by the relevant TSO (: the activation and tuning of the PSS function will be required depending on the connection point, size and the characteristic of the concerned SPGM).

6.3.3 Technical capabilities to support angular stability under fault conditions for SPGM [Art 19-3]

No generic capabilities regarding SPGM to aid angular stability under fault condition are requested to all units. The TSO and the PFGO should agree on these capabilities during the connection process on a case by case basis and fixed in the individual connection contract with the relevant TSO.

6.4 Type D - PPM

6.4.1 Fault-ride through for symmetrical and asymmetrical faults – PPM [Art 16-3]

This requirement should be met at the connection point.

The PPM unit should be able to support the network during fast transient voltages and network short-circuits for which the profile of the voltage versus time is referred as Fault-Ride-Through (FRT). PPM unit shall fulfil the requirements in Figure 21, where the PPM unit shall remain connected to the grid as long as the voltage of the phase having the lower voltage is above the profile of the figure below.

It is recommended however to remain connected as long as the technical capability of the PPM would allow. The same profile applies for asymmetrical faults.

The proposed fault-ride-through parameters are presented in Tabel .

A voltage $U=1$ pu represents the rated voltage (phase-to-phase) at the connection point.

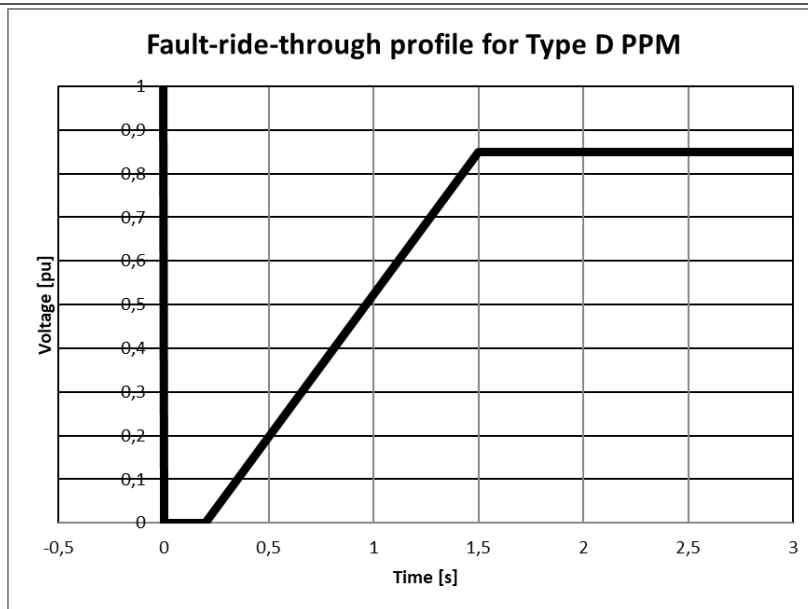

Figure 21: FRT requirement for PPM type D.

Table 6 : Parameters of the FRT requirements for PPM of type D.

Voltage parameters [pu]	Time parameters [seconds]
Uret=Uclear=Uret1= 0	Tclear=trec1=trec2= 0.2
Urec2 = 0.85	trec 3=1.5

7 Acronyms

SGU	Significant Grid User
PGM	Power Generating Module
LFSM	Limited Frequency Sensitive Mode
FRT	Fault Ride Through
PGM	Power Generating Module
PPM	Power Park Module
SPGM	Synchronous Power-Generating Modules
RfG	Requirement for Grid connection of generators
NCC	Elia National Control Center
PGFO	Power Generating Facility Owner
LOM	Loss Of Main

8 References

[1] 'Network Code Requirements for Generators' or 'NC RfG': Commission Regulation (EU) 2016/631 of 14 April 2016 establishing a network code on requirements for grid connection of generators, <http://eur-lex.europa.eu/legal-content/EN/TXT/PDF/?uri=CELEX:32016R0631&from=EN>

[2] 'Network Code on Demand Connection' or 'NC DCC': Commission Regulation (EU) 2016/1388 of 17 August 2016 establishing a Network Code on Demand Connection, <http://eur-lex.europa.eu/legal-content/EN/TXT/PDF/?uri=CELEX:32016R1388&from=EN>

[3] 'Network Code on High Voltage Direct Current' or 'NC HVDC': Commission Regulation (EU) 2016/1447 of 26 August 2016 establishing a network code on requirements for grid connection of high voltage direct current systems and direct current-connected power park modules, <http://eur-lex.europa.eu/legal-content/EN/TXT/PDF/?uri=CELEX:32016R1447&from=EN>

[4] Federal Technical Reglement- 19 DECEMBER 2002. — Koninklijk besluit houdende een technisch reglement voor het beheer van het transmissienet van elektriciteit en de toegang ertoe, Arrêté royal établissant un règlement technique pour la gestion du réseau de transport de l'électricité et l'accès à celui-ci, <http://www.elia.be/~media/files/Elia/publications-2/grid-codes/Technisch%20reglement%20Federaal%202002.pdf>

[5] Presentation FOD/SPF Energy in WG Belgian Grid (in Dutch): http://www.elia.be/~media/files/Elia/users-group/WG%20Belgian%20Grid/20170307%20WG%20Belgian%20Grid/FOD_Vision-for_FederalGridCode.pdf

Minutes of Meeting WG Belgian Grid 7th March 2017 (in French): http://www.elia.be/~media/files/Elia/users-group/WG%20Belgian%20Grid/20170421_WG%20BG/20170307_PV_WGBG_FR_FINAL_WRITTEN-APPROVED.pdf

[6] ENTSO-E Guidance document for national implementation for network codes on grid connection : Parameters of Non-exhaustive requirements, 16 November 2016: https://www.entsoe.eu/Documents/Network%20codes%20documents/NC%20RfG/161116_IGD_General%20guidance%20on%20parameters_for%20publication.pdf

[7] Frequency Stability Evaluation Criteria for the Synchronous Zone of Continental Europe, SPD WG, March 2016:

9 Appendix I – Definition FRT profile (extract from Art. 14.3 RfG[1])

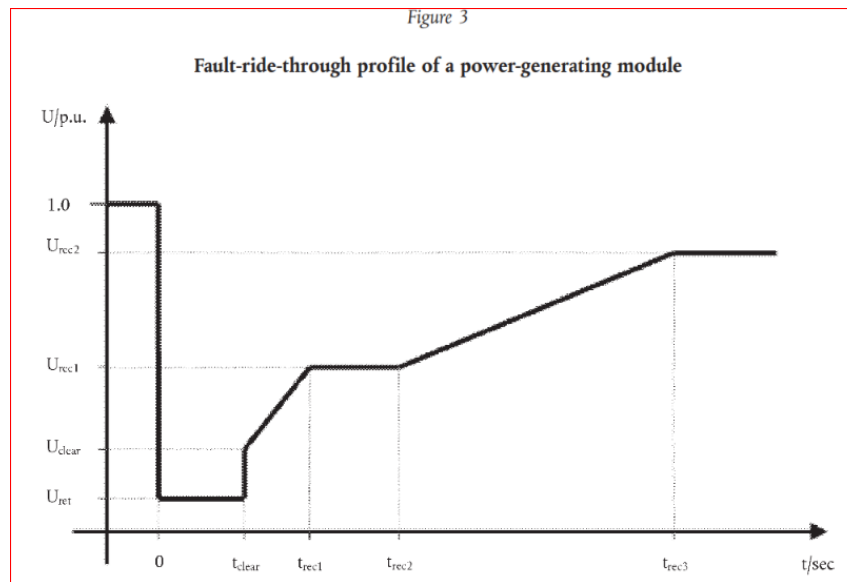

10 Appendix II - List of non-exhaustive articles for RfG

This list is extracted from ENTSO-E Guidance document for national implementation for network codes on grid connection : Parameters of Non-exhaustive requirements [6]

Table 1 – RfG Non-Exhaustive Requirements

Type	Non-Exhaustive Requirement	Non-Mandatory Requirement	Article	Applicability	Parameters to be defined	Timing of proposal	Proposer
FREQUENCY ISSUES	FREQUENCY RANGES		13.1.a.(i)	A, B, C, D	Time period for operation in the frequency ranges Continental Europe 47.5 - 48.5 Hz and 48.5 - 49 Hz Nordic :48.5 - 49 Hz GB :48.5 - 49 Hz Ireland :48.5 - 49 Hz Baltic : 47.5 - 48.5 Hz and 48.5 - 49 Hz and 51 - 51,5 Hz	Value - CNC national implementation	TSO
		X	13.1.a.(ii)	A, B, C, D	Agreement on wider frequency ranges, longer minimum times for operation or specific requirements for combined frequency and voltage deviations	Value - in due time for plant design	agreement between the RSO (DSO or TSO), in coordination with the TSO, and the Power Generating Facility Owner (PGFO)
	RATE OF CHANGE OF FREQUENCY (ROCOF) WITHSTAND CAPABILITY		13.1.(b)	A, B, C, D	- Maximum ROCOF for which the Power Generating Module (PGM) shall stay connected	Value - CNC national implementation	TSO
					specify ROCOF of the loss of main protection	In due time for plant design	RSO in coordination with the TSO
	LIMITED FREQUENCY SENSITIVE MODE (LFSM)-O		13.2.(a)	A, B, C, D	Frequency threshold and droop settings	Range – CNC national implementation Value – before plant commissioning and to be reselected as appropriate using the capabilities defined at CNC national implementation	TSO
		X	13.2(b)	A	Use of automatic disconnection and reconnection	Value and criteria - CNC national implementation	TSO
		X	13.2(f)	A, B, C, D	Expected behaviour of the PGM once the minimum regulating level is reached	CNC national implementation	TSO
	ADMISSIBLE ACTIVE POWER REDUCTION FROM MAXIMUM OUTPUT WITH FALLING FREQUENCY		13.4	A, B, C, D	Admissible active power reduction from maximum output with falling frequency	CNC national implementation and reviewed in due time for plant design	TSO
			13.5	A, B, C, D	definition of the ambient conditions applicable when defining the admissible active power reduction and take	CNC national implementation and reviewed in due time for	TSO

Type	Non-Exhaustive Requirement	Non-Mandatory Requirement	Article	Applicability	Parameters to be defined	Timing of proposal	Proposer
					account of the technical capabilities of power-generating modules	plant design	
	LOGIC INTERFACE	X	13.6	A, B, C, D	Requirements for the additional equipment necessary to allow active power output to be remotely operable	In due time for plant design	RSO
	AUTOMATIC CONNECTION TO THE NETWORK		13.7	A, B, C, D	Conditions for automatic connection to the network, including: - frequency ranges and corresponding delay time - Maximum admissible gradient of increase in active power output	CNC national implementation	TSO
	LOGIC INTERFACE	X	14.2.b	B, C, D	Requirements for the equipment necessary to make the logic interface (to cease active power output) remotely operable	In due time for plant design	RSO
	FREQUENCY STABILITY		15.2.(a)	C, D	Time period for reaching x% of the target output	CNC national implementation	TSO
	LFSM-U		15.2.c	C, D	Definition of the frequency threshold and droop	Range – CNC national implementation Adjustable Setting – In due time for plant design and to be reselected as appropriate using the capabilities defined at CNC national implementation	TSO
				C, D	Definition of Pref	CNC national implementation	TSO
	FREQUENCY SENSITIVE MODE		15.2.d.(i)	C, D	Parameters of the Frequency Sensitive Mode (FSM): - Active power range related to maximum capacity - Frequency response insensitivity - Frequency response dead band - Droop	Range – CNC national implementation Adjustable Setting – In due time for plant design and to be reselected as appropriate using the capabilities defined at CNC national implementation	TSO
			15.2.d.(iii)	C, D	Maximum admissible full activation time	CNC national implementation	TSO
		X	15.2.d.(iv)	C, D	Maximum admissible initial delay for power generating modules without inertia	CNC national implementation	TSO

Type	Non-Exhaustive Requirement	Non-Mandatory Requirement	Article	Applicability	Parameters to be defined	Timing of proposal	Proposer
			15.2.d.(v)	C, D	time period for the provision of full active power frequency response	CNC national implementation	TSO
	FREQUENCY RESTORATION CONTROL		15.2.e	C, D	Specifications of the Frequency Restoration Control	CNC national implementation	TSO
	REAL-TIME MONITORING OF FSM	X	15.2.g	C, D	List of the necessary data which will be sent in real time	In due time for plant design	RSO (DSO or TSO) or TSO
					definition of additional signals	In due time for plant design	RSO (DSO or TSO) or TSO
	RATES OF CHANGE OF ACTIVE POWER OUTPUT		15.6.e	C, D	Definition of the minimum and maximum limits on rates of change of active power output (ramping limits) in both an up and down direction, taking into consideration the specific characteristics of the prime mover technology	CNC national implementation and reviewed in due time for plant design	RSO in coordination with the TSO
SYNTHETIC INERTIA CAPABILITY FOR POWER PARK MODULE (PPM)	X	21.2	PPM: C, D	Definition of the operating principle of control systems to provide synthetic inertia and the related performance parameters	CNC national implementation	TSO	
VOLTAGE ISSUES	FAULT RIDE THROUGH CAPABILITY		14.3.a	B, C, D	Voltage-against-time profile	CNC national implementation	TSO
			14.3.a	B, C, D	pre-fault and post-fault conditions	CNC national implementation	TSO
			14.3.b	B, C, D	Voltage-against-time profile for asymmetric faults	CNC national implementation	TSO
			16.3.a.(i)	D	voltage-against-time profile	CNC national implementation	TSO
			16.3.a.(ii)	D	pre-fault and post-fault conditions	CNC national implementation	TSO
			16.3.c	D	Voltage-against-time profile for asymmetric faults	CNC national implementation	TSO
	ACTIVE POWER CONTROLLABILITY AND CONTROL RANGE		15.2.a	C, D	Time period to reach the adjusted active power set point Tolerance applying to the new set point and the time to reach it.	CNC national implementation	RSO (DSO or TSO) or TSO
	AUTOMATIC DISCONNECTION DUE TO VOLTAGE LEVEL		15.3	C, D	Voltage criteria and technical parameters at the connection point for automatic disconnection	Value - in due time for plant design	RSO (DSO or TSO), in coordination with the TSO
	VOLTAGE RANGES		16.2.a.(i)	D	For Continental Europe time period for operation in the voltage range 1,118 pu-1,15 pu for PGM connected between 110kV and 300 kV	Value - CNC national implementation	TSO
X		16.2.a.(ii)	D	Determination of shorter time periods in the event of simultaneous overvoltage and under frequency or simultaneous under voltage and over frequency	CNC national implementation	relevant TSO	

Type	Non-Exhaustive Requirement	Non-Mandatory Requirement	Article	Applicability	Parameters to be defined	Timing of proposal	Proposer
		X	16.2.a.(iii)	D	For Spain time period for operation in the voltage range 1,05 pu-1,0875 pu for PGMs connected between 300kV and 400 kV may be specified as unlimited	Value - CNC national implementation	TSO
		X	16.2.a.(v)	D	For Baltic voltage ranges and time period for operation may be specified in line with continental Europe for facilities connected for 400 kV	Value - CNC national implementation	TSO
			16.2.b	D	Wider voltage ranges or longer minimum time periods for operation may be agreed.	Value - in due time for plant design	agreement between the RSO and the PGFO, in coordination with the TSO
	REACTIVE POWER CAPABILITY FOR SYNCHRONOUS PGM	X	17.2.a	Synchronous B, C, D	Capability to supply or absorb reactive power	Range -CNC national implementation	RSO
	SUPPLEMENTARY REACTIVE POWER FOR SYNCHRONOUS PGM	X	18.2.a	Synchronous C, D	Definition of supplementary reactive power to compensate for the reactive power demand of the high-voltage line or cable when the connection point is not located at the HV side of the step-up transformer	Range - CNC national implementation	RSO
	REACTIVE POWER CAPABILITY AT MAXIMUM CAPACITY FOR SYNCHRONOUS PGM		18.2.b.(i)	Synchronous C, D	Definition of a U-Q/Pmax-profile at maximum capacity	Range of capability - CNC national implementation	RSO in coordination with the TSO
			18.2.b.(iv)	Synchronous C, D	appropriate timescale to reach the target value	Value -CNC national implementation	RSO
	VOLTAGE STABILITY FOR SYNCHRONOUS PGM		19.2.b.(v)	Synchronous D	Power threshold above which a PSS function is to be specified	Value -CNC national implementation	TSO
	REACTIVE POWER CAPABILITY FOR PPM	X	20.2.a	PPM: B, C, D	Capability to supply or absorb reactive power	Range of capability - CNC national implementation	RSO

Type	Non-Exhaustive Requirement	Non-Mandatory Requirement	Article	Applicability	Parameters to be defined	Timing of proposal	Proposer
	FAST FAULT CURRENT INJECTION FOR PPM	X	20.2.b	PPM: B, C, D	Specifications of: - how and when a voltage deviation is to be determined as well as the end of the voltage deviation - Fast fault current characteristics - Timing and accuracy of the fast fault current, which may include several stages during a fault and after its clearance	Values -CNC national implementation	RSO in coordination with the TSO
		X	20.2.c	PPM: B, C, D	Specifications for asymmetrical current injection, in case of asymmetric faults (1-phase or 2-phase)	Value -CNC national implementation	RSO in coordination with the TSO
	SUPPLEMENTARY REACTIVE POWER FOR PPM	X	21.3.a	PPM: C, D	Definition of supplementary reactive power for a PPM whose connection point is not located at the high-voltage terminals of its step-up transformer nor at the terminals of the high-voltage line or cable to the connection point at the PPM, if no step-up transformer exists	Range -CNC national implementation	RSO
	REACTIVE POWER CAPABILITY AT MAXIMUM CAPACITY FOR PPM		21.3.b	PPM: C, D	Definition of a U-Q/Pmax-profile at maximum capacity	Range of capability - CNC national implementation	RSO in coordination with the TSO
	REACTIVE POWER CAPABILITY BELOW MAXIMUM CAPACITY FOR PPM		21.3.c.(i) 21.3.c.(ii)	PPM: C, D	definition of a P-Q/Pmax-profile below maximum capacity	Range of capability- CNC national implementation	RSO in coordination with the TSO
			21.3.c.(iv)	PPM: C, D	appropriate timescale to reach the target values	Value - CNC national implementation	RSO
	REACTIVE POWER CONTROL MODES FOR PPM		21.3.d.(iv)	PPM: C, D	In voltage control mode: t1 = time within which 90% of the change in reactive power is reached t2 = time within which 100% of the change in reactive power is reached	Values - CNC national implementation	RSO
			21.3.d.(vi)	PPM: C, D	In power factor control mode: - Target power factor - Time period to reach the set point - Tolerance	Ranges - CNC national implementation	RSO
			21.3.d.(vii)	PPM: C, D	Specifications of which of the above three reactive power control mode options and associated set points is to apply, and what further equipment is needed to make the adjustment of the relevant set point operable remotely;	in due time for plant design	RSO, in coordination with the TSO and the PGFO
	PRIORITY TO ACTIVE OR REACTIVE POWER CONTRIBUTION FOR PPM		21.3.e	PPM: C, D	Specification of whether active power contribution or reactive power contribution has priority during faults for which fault-ride-through capability is required.	CNC national implementation	relevant TSO

Type	Non-Exhaustive Requirement	Non-Mandatory Requirement	Article	Applicability	Parameters to be defined	Timing of proposal	Proposer	
	VOLTAGE RANGES FOR OFFSHORE PPM		25.1	Offshore	For Continental Europe time period for operation in the voltage range 1,118 pu-1,15 pu for PGM connected between 110kV and 300 kV	Value - CNC national implementation	TSO	
	VOLTAGE CONTROL SYSTEM FOR SYNCHRONOUS PGM		19.2.a	Synchronous D	- Parameters and settings of the components of the voltage control system - Specifications of the AVR	Ranges - in due time for plant design	agreement between the PGFO and the RSO, in coordination with the TSO	
	VOLTAGE RANGES			25.1	Offshore	For Continental Europe time period for operation in the voltage range 1,118 pu-1,15 pu, 1,05pu-1,10pu for PGM For Nordic time period for operation in the voltage range 1,05pu-1,10pu for PGM	Value - CNC national implementation	TSO
		X		16.2.a.(iii)	Offshore	For Spain time period for operation in the voltage range 1,05 pu-1,0875 pu for PGMs connected between 300kV and 400 kV may be specified as unlimited	Value - CNC national implementation	TSO
		X		16.2.a.(v)	Offshore	For Baltic voltage ranges and time period for operation may be specified in line with continental Europe for facilities connected for 400 kV	Value - CNC national implementation	TSO
	REACTIVE POWER CAPABILITY AT MAXIMUM CAPACITY FOR OFFSHORE PPM			25.5	Offshore	Definition of the U-Q/Pmax-profile at Pmax	Range of capability- CNC national implementation	TSO
SYSTEM RESTORATION	CAPABILITY OF RECONNECTION AFTER AN INCIDENTAL DISCONNECTION CAUSED BY A NETWORK DISTURBANCE		14.4.a	B, C, D	Conditions for reconnection to the network after an incidental disconnection caused by network disturbance	CNC national implementation	TSO	
			14.4.b	B, C, D	Conditions for automatic reconnection	CNC national implementation	TSO	
	BLACK START CAPABILITY	X		15.5.a.(ii)	C, D	Technical specifications for a quotation for Black Start Capability	Principle - CNC national implementation in due time for plant design	TSO
		X		15.5.a.(iii)	C, D	Timeframe within which the PGM is capable of starting from shutdown without any external electrical energy supply	Value - CNC national implementation	RSO (DSO or TSO) in coordination with the TSO

Type	Non-Exhaustive Requirement	Non-Mandatory Requirement	Article	Applicability	Parameters to be defined	Timing of proposal	Proposer
		X	15.5.a.(iv)	C, D	voltage limits for synchronisation when art.16.2 non applicable	Range - CNC national implementation	RSO (DSO or TSO)
	CAPABILITY TO TAKE PART IN ISLAND OPERATION	X	15.5.b.(iii)	C, D	Methods and criteria for detecting island operation	In due time for plant design	agreement between the PGFO and the RSO (DSO or TSO), in coordination with the TSO
	OPERATION FOLLOWING TRIPPING TO HOUSELOAD		15.5.c.(iii)	C, D	Minimum operation time within which the PGM is capable of operating after tripping to house load	Value - CNC national implementation	RSO (DSO or TSO), in coordination with the TSO
	ACTIVE POWER RECOVERY FOR SYNCHRONOUS PGM		17.3	Synchronous B, C, D	Definition of the magnitude and time for active power recovery	Value - CNC national implementation	TSO
	POST FAULT ACTIVE POWER RECOVERY FOR PPM		20.3.a	PPM: B, C, D	Specifications of the post-fault active power recovery Following specifications: - when the post-fault active power recovery begins, based on a voltage criteria - a maximum allowed time for active power recovery - a magnitude and accuracy for active power recovery	Value - CNC national implementation	TSO
INSTRUMENTATION SIMULATION MODELS AND PROTECTION	CONTROL SCHEME AND SETTINGS		14.5.a	B, C, D	control schemes and settings of the control devices	Control schemes: in due time for plant design Settings: Values - before plant commissioning and to be reselected as appropriate	agreement and coordination between the TSO, the RSO (TSO and DSO) and the PGFO
	ELECTRICAL PROTECTION SCHEMES AND SETTINGS		14.5.b	B, C, D	protection schemes and settings	Protection schemes: in due time for plant design Settings: Values - before plant commissioning and to be reselected as appropriate	agreement and coordination between the RSO and the PGFO
	INFORMATION EXCHANGES		14.5.d	B, C, D	Content of information exchanges and precise list and time of data to be facilitated.	Principle - CNC national implementation	RSO (DSO or TSO) or TSO

Type	Non-Exhaustive Requirement	Non-Mandatory Requirement	Article	Applicability	Parameters to be defined	Timing of proposal	Proposer
						Value - in due time for plant design	
	MANUAL, LOCAL MEASURES WHERE THE AUTOMATIC REMOTE DEVICES ARE OUT OF SERVICE		15.2.b	C, D	Time period and tolerance requested to reach the set point in cases where the automatic remote control devices are out of service	Value - in due time for plant design	RSO (DSO or TSO) or TSO
	LOSS OF ANGULAR STABILITY OR LOSS OF CONTROL		15.6.a	C, D	criteria to detect loss of angular stability or loss of control	Value - in due time for plant design	Agreement between the PGFO and the RSO (DSO or TSO), in coordination with the TSO.
	INSTRUMENTATION	X	15.6.b.(i)	C, D	Definition of the quality of supply parameters	in due time for plant design	RSO
			15.6.b.(ii)	C, D	Settings of the fault recording equipment, including triggering criteria and the sampling rates	Value - in due time for plant design	Agreement between the PGFO and the RSO (DSO or TSO), in coordination with the TSO.
			15.6.b.(iii)	C, D	Specifications of the oscillation trigger detecting poorly damped power oscillations	Value - in due time for plant design	RSO in coordination with the TSO
			15.6.b.(iv)	C, D	Protocols for recorded data.	in due time for plant design	agreement between the PGFO, the RSO and the relevant TSO
	SIMULATION MODELS	X	15.6.c.(iii)		Specifications of the simulation models	CNC national implementation	RSO in coordination with the TSO
	INSTALLATION OF DEVICES FOR SYSTEM OPERATIONS AND SYSTEM SECURITY	X	15.6.d	C, D	Definition of the devices needed for system operation and system security	In due time for plant design	RSO or TSO and PGFO
	NEUTRAL-POINT AT THE NETWORK SIDE OF STEP-UP TRANSFORMERS		15.6.f	C, D	Specifications of the earthing arrangement of the neutral-point at the network side of step-up transformers	Principle - CNC national implementation Value - in due time for plant design and to be reselected as appropriate	RSO
	AUTOMATIC DISCONNECTION	X	16.2.c	D	Definition of the threshold for automatic disconnection	Value - in due time for plant design	RSO in coordination with the TSO

Type	Non-Exhaustive Requirement	Non-Mandatory Requirement	Article	Applicability	Parameters to be defined	Timing of proposal	Proposer
					Definition of the parameters	Values - in due time for plant design	agreement between le RSO and the PGFO
	SYNCHRONISATION		16.4	D	Settings of the synchronisation devices	Range – CNC national implementation Value – before plant commissioning and to be reselected as appropriate	agreement between le RSO et the PGFO
	ANGULAR STABILITY UNDER FAULT CONDITIONS		19.3	Synchronous	Agreement for technical capabilities of the PGM to aid angular stability.	In due time for plant design	agreement between the TSO and the PGFO
	SYNTHETIC INERTIA CAPABILITY FOR PPM	X	21.2	PPM: C, D	- Definition of the operating principle of control systems to provide synthetic inertia and the related performance parameters	CNC national implementation	TSO