



TECHNICAL GUIDE FOR IMPLEMENTATION

OPA Contract, SA Contract, BSP Contract aFRR, BSP
Contract mFRR

Version 5.2

Deleted: 1

Disclaimer

This is a technical document drafted to facilitate the IT implementations needed in the framework of the BSP Contract (aFRR and mFRR), the SA Contract and the OPA Contract. As such the mutual rights and obligations of Elia and respectively the BSP, the SA or the OPA specified in the regulated BSP



Contract, SA Contract or OPA Contract prevail over the provided technical documents in case of inconsistencies.

Table of Contents

1	Document Version and contact persons	7
1.1	Document version.....	7
1.2	Contact person.....	7
2	Introduction.....	8
2.1	Background	8
2.2	Scope.....	8
3	Overview of communication requirements	9
3.1	Requierments for Outage Planning Agents	9
3.2	Requierments for Scheduling Agents	10
3.3	Requierments for Balancing Service Providers.....	11
4	External Communication Layer.....	14
4.1	General details.....	14
4.2	Connection Information.....	15
4.3	Queues and exchanges naming convention	16
4.4	Message operations.....	20
5	Generic message specifications.....	24
5.1	JSON format and date format.....	24
5.2	Market document structure	27
5.3	Identification and versioning	28
5.4	Message granularity	29
6	Acknowledgement and answer messages.....	30
6.1	Acknowledgement.....	30
6.2	Answer	31
7	Notification messages.....	33
7.1	Description.....	33
7.2	Notification submitted message.....	33
7.3	Notification acknowledged message.....	35

8	Outage Planning Agent Guide	36
8.1	Role overview	36
8.2	Submitting unavailability events.....	36
8.3	Receiving a Market Party notification	43
9	Scheduling Agent Guide.....	45
9.1	Role overview	45
9.2	Bid structure	45
9.3	Submitting schedules.....	51
9.4	Receiving a return to schedule request	55
9.5	Submitting redispatching bids	58
9.6	Receiving a redispatching activation request	66
9.7	Receiving a Market Party notification	76
9.8	Receiving a redispatching communication test	76
9.9	Receiving a Market Party notification	83
9.10	Retrieving Schedules.....	84
9.11	Retrieving Energy Bids	89
10	Balancing Service Provider Guide	96
10.1	Role overview	96
10.2	Bid structure	96
10.3	Submission of mFRR Energy Bids.....	102
10.4	Submission of mFRR backup Delivery Points.....	110
10.5	Submitting schedule update for mFRR baseline.....	114
10.6	Reception of mFRR activation request	118
10.7	Reception of mFRR communication test request.....	127
10.8	Submitting aFRR Energy Bids	133
10.9	Submitting aFRR backup Delivery Points.....	140
10.10	Reception of aFRR activation request.....	143
10.11	Reception of aFRR communication test request	150
10.12	Submitting Prequalification Bids.....	156

Deleted: 75

Deleted: 126

Deleted: 149

- 10.13 Receiving bid confirmations 162
- 10.14 Receiving CRI levels..... 165
- 10.15 Receiving a Market Party notification 170
- 10.16 Retrieving Energy Bids 171
- 10.17 Retrieving schedule update for mFRR baseline 178
- 11 Merged Energy Bids Guide 183
 - 11.1 Role overview 183
 - 11.2 Submission of merged mFRR and Redispatching Energy Bids 186
- 12 Validation rules description 196
 - 12.1 Generic..... 196
 - 12.2 Outage Planning..... 203
 - 12.3 Scheduling..... 205
 - 12.4 Bidding 209
 - 12.5 Backup Delivery Points 236
 - 12.6 Activations 238
 - 12.7 Requests..... 239
- 13 MarketDocuments 240
 - 13.1 Schedule_MarketDocument 240
 - 13.2 ReserveBid_MarketDocument..... 242
 - 13.3 Activation_MarketDocument 245
 - 13.4 Unavailability_MarketDocument..... 247
 - 13.5 Notification_MarketDocument 249
 - 13.6 Acknowledgment_MarketDocument 250
 - 13.7 Confirmation_MarketDocument 251
 - 13.8 BackupDeliveryPoints_MarketDocument..... 253
 - 13.9 CRILevel_MarketDocument..... 255
 - 13.10 ActivationConfirmation_MarketDocument..... 257
 - 13.11 BidConfirmation_MarketDocument..... 259
 - 13.12 Request_MarketDocument 261

Deleted: 235

Deleted: 237

Deleted: 238

Deleted: 239

Deleted: 239

Deleted: 241

Deleted: 244

Deleted: 246

Deleted: 248

Deleted: 249

Deleted: 250

Deleted: 252

Deleted: 254

Deleted: 256

Deleted: 258

Deleted: 260

1 Document Version and contact persons

1.1 Document version

Version	Date	Changes
1.0	21/05/2021	First published version of the document
2.0	08/11/2021	Second published version of the document
2.1	01/03/2022	Minor updates on the second published version
2.2	25/08/2022	Added bid retrieval and other minor updates
3.0	30/09/2022	MARI/iCAROS updates
4.0		
5.0	11/08/2023	Updates on mFRR and aFRR activation code type document. Update on back-up communications Update on MAT/MEL/NT

1.2 Contact person

For any question, please contact your KAM Energy:

Name	E-mail
Amandine Leroux	Amandine.leroux@elia.be
Nicolas Koelman	Nicolas.Koelman@elia.be
Sybillie Mettens	Sybillie.Mettens@elia.be

For specific IT-related question, please contact the following email address:

E-mail
IT-ECL@elia.be

2 Introduction

2.1 Background

The Elia External Communication Layer must be used by Market Parties (Balancing Service Providers, Outage Planning Agents and Scheduling Agents) for the new market interactions defined in the T&C OPA, T&C SA, T&C BSP mFRR and T&C BSP aFRR that will be released at a later date.

The format of all communications through this platform is based on the CIM standards, with some modifications defined by Elia when local needs required it.

This guide contains general technical information about the External Communication Layer and specific information on communication required by each market role in the context of the T&Cs.

2.2 Scope

This implementation guide provides all the information that you need to adapt your systems in order to communicate with Elia.

This document is directed to BSPs, SAs and OPAs.

The main topics covered by this document are:

- Technical description of the External Communication Layer.
- Overview of communication flows for each Market Party role.
- Description of all messages exchanges for each Market Party role:
 - o Scheduling Agent
 - o Balancing Service Provider
 - o Outage Planning Agent
- Message format definition (MarketDocuments)

Note that for all the incoming data (schedules, unavailabilities, bids) Elia will create a webclient in which Market Parties can introduce their data manually. The webclient will offer a user interface where Market Parties can have a view on the status of (automatically or manually) sent data. The documentation concerning this solution will be sent in later phase.

3 Overview of communication requirements

The present section describes the communication channels used by Elia to communicate and receive information to and from the different market parties in the context of iCAROS phase 1 and the MARI project.

The communication channels are separated in:

- “Main communication channel(s)” that have to be used by the market parties. If several channels are available, the BSP/SA/OPA can chose to use only one of them or all of them.
- “Back-up communication channel(s)” that have to be used by the market parties. If several channels are available, the BSP/SA/OPA can chose to use only one of them or all of them. The BSP must have a back-up communication channel. Working in back-up mode do not imply working in a degraded mode and should ensure the same quality level of services from Elia and the Market Party.

Each Market Party is required to implement at least:

- One Main communication channel and;
- One Back-up communication channel.

According to the exchanges, the different communication channels are:

- The External Communication Layer (ECL) described in the present document.
- WebClient (B2C) described in the Biple and Optiflex user manuals.
- The e-mail.
- ...

3.1 Requierments for Outage Planning Agents

An outage planning agent is involved in the following communications:

- Submission of unavailability events
- Market Party notifications sent by Elia

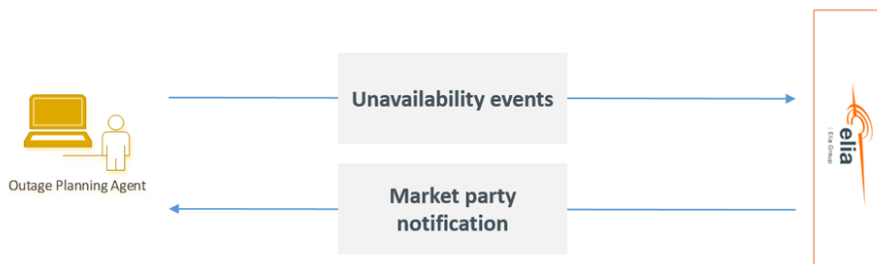

1. The outage planning agent can either submit **unavailability events** via:
Main communication channel:

- The External Communication Layer put in place by Elia and to be used for the exchange of asynchronous messages between Elia and Market Parties.
- The Webclient available for the Market Parties to upload their data manually using an Excel template. The webclient offers a user interface where Market Parties can have a view on the status of (automatically or manually) sent data.

Back-up communication channel:

- Each of the main communication channel is the back-up for the other one.

2. **Market Party notifications** are sent by the Notification Service via:

- JSON messages via ECL
- Automated emails

3.2 Requierments for Scheduling Agents

A Scheduling Agent is involved in the following communications:

- Submission of schedules
- Return-to-schedule requests
- Submission of redispatching bids
- Activation of redispatching bids
- Market Party notifications sent by Elia

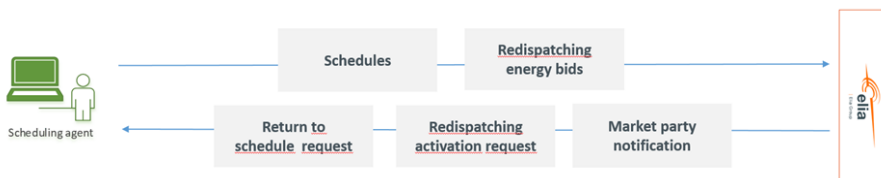

1. The scheduling agent can either submit **schedules** via:

Main communication channel:

- The External Communication Layer put in place by Elia and to be used for the exchange of asynchronous messages between Elia and Market Parties.
- The Webclient available for the Market Parties to upload their data manually using an Excel template. The webclient offers an user interface where Market Parties can have a view on the status of (automatically or manually) sent data.

Back-up communication channel:

Each of the main communication channel is the back-up for the other one.

2. Elia can either submit their **return to schedules requests** via:

Main communication channel:

- Elia will send out return-to-schedule commands towards the Scheduling Agent via an asynchronous message to request a return to schedule to the SA . The SA will generate an acknowledgement indicating the good reception of the activation message.

Back-up communication channel:

- Details of activations can also be sent via emails (JSON file provided) via Notification Service (other type of Notification) automatically only in case of issue in main communication channel.

3. The scheduling agent can either submit **redispatching bids** via:

Main communication channel:

- The External Communication Layer put in place by Elia and to be used for the exchange of asynchronous messages between Elia and Market Parties.
- The Webclient available for the Market Parties to upload their data manually using an Excel template. The webclient offers a user interface where Market Parties can have a view on the status of (automatically or manually) sent data.

Back-up communication channel:

Each of the main communication channel is the back-up for the other one.

4. Elia can communicate **activation of redispatching bids** via:

Main communication channel:

- The External Communication Layer put in place by Elia and to be used for the exchange of asynchronous messages between Elia and Market Parties.

Back-up communication channel:

- Details of activations can also be sent via emails (JSON file provided) (described in 9.6.8) via Notification Service (other type of Notification) automatically only in case of issue in main communication channel.

5. **Notifications** are sent by the Notification Service via:

- JSON messages via ECL
- Automated emails

3.3 Requierments for Balancing Service Providers

A Balancing Service Provider is involved in the following communications:

- Submission of aFRR and mFRR energy bids as well as the list of back-up Delivery Points (Supporting providing group)
- Activation of mFRR energy bids
- Reception of CRI levels from Elia
- Market Party notifications sent by Elia

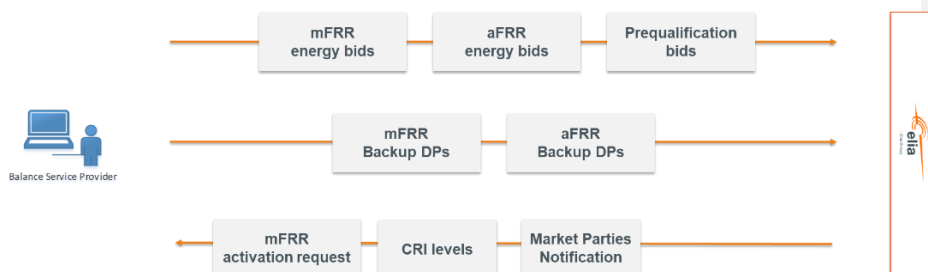

1. The Balancing Service Provider can either submit energy and prequalification **bids and backup DPs** via:

Main communication channel:

- The External Communication Layer put in place by Elia and to be used for the exchange of asynchronous messages between Elia and Market Parties.
- The Webclient available for the Market Parties to upload their data manually using an Excel template. The webclient offers a user interface where Market Parties can have a view on the status of (automatically or manually) sent data.

Back-up communication channel:

Each of the main communication channel is the back-up for the other one.

2. Elia can communicate **activation of mFRR bids** via:

Main communication channel:

- The External Communication Layer put in place by Elia and to be used for the exchange of asynchronous messages between Elia and Market Parties.

Back-up communication channel:

- Activation requests are sent automatically via e-mail in case no technical acknowledgement is received from the BSP (described in 10.6.8).

3. Elia can communicate **CRI levels** (useful for the BSP to adapt their bids, on best effort basis, to avoid filtering) via:

Main communication channel:

- The External Communication Layer put in place by Elia and to be used for the exchange of asynchronous messages between Elia and Market Parties.
 - All specific information available: bids and DP impacted by the CRI levels for electrical zones with a medium or high CRI level
- Notifications can be sent via emails with the list of electrical zones which are updated
 - Only the electrical zones that concern the BSP and their respective levels
- The Webclient available for the Market Parties to upload their data manually. The webclient offers a user interface where Market Parties can have a view on the bids impacted by a high or medium CRI level.

- CRI levels are being published on Elia.be
 - All the electrical zones and their respective levels, no MP specific info such as impacted DP or bids,...)

Back-up communication channel:

If the specific information are not available, the generic information can be found on Elia.be

4. Elia can communicate **filtered bids**:

Main communication channel:

- The External Communication Layer put in place by Elia and to be used for the exchange of asynchronous messages between Elia and Market Parties.
 - All specific information available: electrical zone, CRI level, CRIDirection, Filtering Start Period, Filtering End Period, ImpactedBidGroup, Impacted backup Delivery Point
 - The Webclient available for the Market Parties to upload their data manually. The webclient offers a user interface where Market Parties can have a view on the filtered bids.
 - Notifications can be sent via emails with the list of filtered bids
5. **Notifications** are sent by the Notification Service via:
- JSON messages via ECL
 - Automated emails

4 External Communication Layer

The External Communication Layer is put in place by Elia and must be used for the exchange of asynchronous messages between Elia and Market Parties.

This section describes how to use the Elia External Communication Layer to send and receive messages.

4.1 General details

4.1.1 Dedicated queues/exchanges

There are dedicated queues/exchanges for each type of message:

- For messages sent by Elia to a Market Party, there is one **queue** for each type of message. Queues are specific to only one Market Party. This means that only one Market Party can read messages from each queue.
- For messages sent by a Market Party to Elia, there is one **exchange** for each type of message. An exchange is not specific to each Market Party. It can be used by multiple Market Parties to send messages.

4.1.2 Sending messages

For sending a message to the External Communication Layer, the Market Party has to write the message to the corresponding Exchange.

The *'Write pattern'* must include a retry logic: the sender is responsible to ensure that the message has been acknowledged by the queuing platform before considering it as delivered.

4.1.3 Receiving messages

For receiving a message out of the External Communication Layer, the Market Party has to read the message from a dedicated queue.

The *'Read pattern'* must include a transaction approach: it is the responsibility of the application that is reading a message to first persist (in storage) the information *before* committing the read of the message on the queue (resulting to its permanent deletion).

The application that is reading a message must foresee re-ordering of messages (when applicable): the messaging system is by design multi-threading/multi-server/multi-site and the order of messages cannot be guaranteed.

4.1.4 Virtual Host

A Virtual Host is a virtual separation of External Communication Layer elements. It contains all elements related to the same domain/concepts.

In the scope of the External Communication Layer, the messages exchanged will be always under the scope of the *'AncillaryServices'* Virtual Host.

4.2 Connection Information

4.2.1 Authentication and Authorization

Every Market Party will receive a dedicated User/Password, per environment (Demo and Prod), that Elia will use for authentication.

A Market Party will only have access to its own queues, with a strictly “read” rights. It means that any ‘QueueDeclare’ operation will fail. Only ‘BasicConsume’ type operation are authorized.

4.2.2 Protocols

AMQP(S) 0.9.1 or 1.0 are supported.

4.2.3 URLs and ports

The following URLs are available for Production and Demo environments:

- Production: messaging.elia.be
- Demo: messaging-demo.elia.be

The available ports to connect are:

- 5672 for AMQP
- 5671 for AMQPS

For the Production environment it is strongly advised to use the encrypted port 5671 to avoid any IT security risk.

For AMQPS: the only supported TLS version is 1.2 for current market parties.

New market parties are requested to use the latest TLS 1.3 protocol given less secure protocols will be phased out in due time aligned with the current market parties.

4.2.4 Virtual Hosts

This Virtual Host has to be specified in the connection parameters when accessing to queues/exchanges:

- ‘AncillaryServices’ for both Production and Demo environment

Formatted: Normal, No bullets or numbering

Formatted: Font: (Default) +Body (Calibri), Font color: Auto

Deleted: ¶

Formatted: English (United States)

Formatted: English (United States)

4.3 Queues and exchanges naming convention

We will firstly describe the normal communication: how a message is sent from Elia to the Market Party and how a message is sent from a Market Party to Elia.

4.3.1 Generic Reading Queue Pattern

The naming convention used for the Queues to read from (*Elia to Market Party communication*) is:

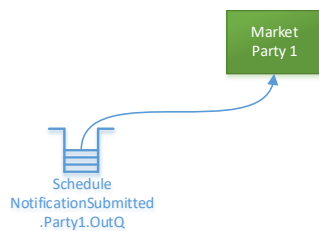

[DataType].[TargetMarketPartyID].OutQ

Where:

- **DataType** describes the messages content (i.e. ScheduleAnswered, UnavailabilityAnswered, ReturnToScheduleRequested, ...)
- **TargetMarketPartyID** is the EIC code of the Market Party to which the message is sent (i.e. 10X1001A1001A094)

Some example of queue names:

- mFRREnergyBidAnswered.10X1001A1001A094.OutQ
- ScheduleAnswered.10X1001A1001A094.OutQ
- ReturnToScheduleRequested.10X1001A1001A094.OutQ

4.3.2 Generic Writing Exchange Pattern

The naming convention used for the Exchange to write to (*Market Party to Elia communication*) is:

[DataType].In.Exch

Where:

- **DataType** describes the messages content (i.e. ScheduleSubmitted, UnavailabilitySubmitted, ReturnToScheduleAcknowledged, ...)

Important: don't forget to setup the header properties 'user-id' to pass the security check of your messages.

Some example of the exchange names:

- mFRREnergyBidSubmitted.In.Exch
- ScheduleSubmitted.In.Exch
- ReturnToScheduleAcknowledged.In.Exch

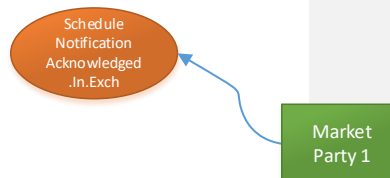

The second part of this section concerns the handling of problematic messages (error handling).

A message is considered as problematic (or *wrong*) when it doesn't respect the agreed format specified in this document. It is therefore important to inform the sender that this message was not understandable. That's the purpose of the "ErrorQueue" and "ErrorExchange".

Note: the Error queues and exchanges are not to be used in case of any other processing error on either side.

4.3.3 Generic Error Exchange Pattern

When the (Market Party) reading process is not able to treat a specific message (read on a *.OutQ) due to a technical validation problem (format of the message is not as expected/agreed), the message is sent back to the source using the *Error Exchange*.

It is always the original message that is moved to the 'Error Exchange', and it is the responsibility of the originator of the message (Elia in this case) to handle this error.

The naming convention used for the Error Exchange is:

[DataType].Error.Exch

Where :

- `DataType` describes the messages content (i.e. ScheduleSubmitted, UnavailabilitySubmitted, ReturnToScheduleAcknowledged, ...)

Important: don't forget to setup the header properties "user-id" to pass the security check of your messages.

Some example of error exchange names:

- mFRREnergyBidAnswered.Error.Exch
- ScheduleAnswered.Error.Exch
- ReturnToScheduleRequested.Error.Exch

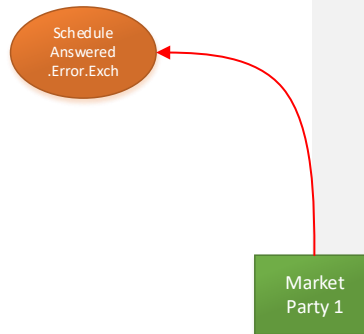

4.3.4 Generic Error Queue Pattern

When the (Elia) reading flow is not able to treat a specific message due to a technical problem (e.g. format is not as expected/agreed), the message is send back to the source (the Market Party) to inform about the problem.

It is always the original message that is moved to the Error queue, and it is the responsibility of the originator of the message (the Market Party in this case) to handle this error.

When Elia doesn't understand a message sent by a Market Party, the message is sent back on an 'Error Queue' dedicated for the specified Market Party. The naming convention used for the Error Queue to is:

[DataType].[TargetMarketPartyID].ErrorQ

Where:

- `DataType` describes the messages content (i.e. ScheduleAnswered, UnavailabilityAnswered, ReturnToScheduleRequested, ...)

- TargetMarketPartyID is the EIC code of the Market Party to which the message is sent (i.e. 10X1001A1001A094)

Some example of queue names:

- mFRREnergyBidSubmitted.10X1001A1001A094.ErrorQ
- ScheduleSubmitted.10X1001A1001A094.ErrorQ
- ReturnToScheduleAcknowledged.10X1001A1001A094.ErrorQ

Remark: the Market Party is responsible to treat (and delete) the messages available on the Error Queues.

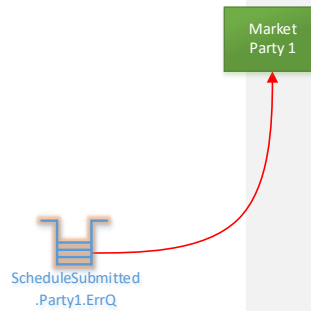

4.3.5 Example of configuration

As an example of the full configuration of normal queues/exchanges and error handling, hereafter we present the 'Schedule' (Market Party Requested → Elia Answered):

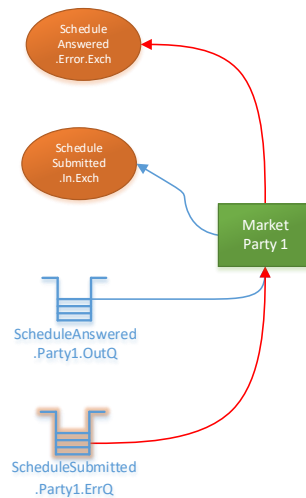

And the example of ReturnToSchedule process (Elia Requested → Market Party Answered):

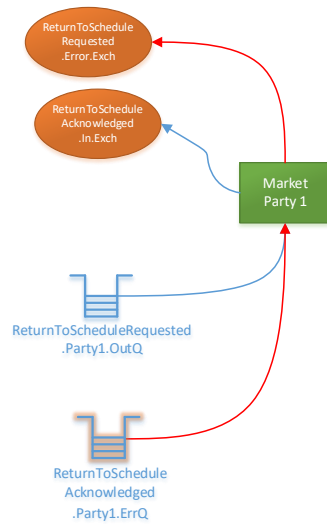

4.4 Message operations

4.4.1 Message structure

A message is composed of 3 parts:

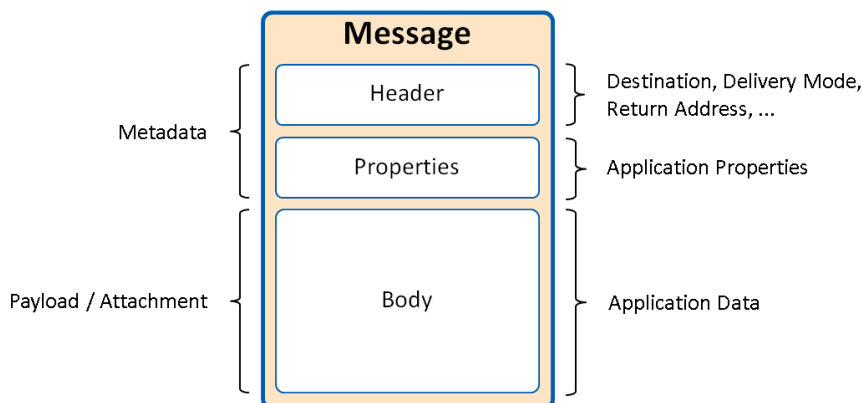

- The **header** (metadata): contains technical metadata information on the message.
- The **properties** (metadata): contains some technical fields required for the security and tracking of the communication. The description is provided hereafter and must be applied to every message exchanged
- The **body** (payload): contains a MarketDocument in JSON format, based on the CIM specifications. Every type of message will be described in future sections of this document

4.4.2 Properties section

The properties section is used to transfer structured exchange metadata on the message.

Three properties are mandatory to facilitate the tracing and the security checks of the messages:

- **message_id**: contains a unique identifier of the message. Every message created on the system must have a unique ID. UUID based ID is recommended.
I.e.: 5eb8aec9-6f58-4b6d-a318-ad050007bfa4
- **correlation_id**: contains the unique identifier of the communication. This ID is used to correlate a message with its acknowledgement or answer message.
If you are the originator of the communication, this ID must be filled in with a unique ID.
If you are sending a message for a communication that is already initiated (answer or acknowledgement message), the correlation_id must be copied from the message that is being answered/acknowledged. UUID based ID is recommended.
I.e.: b30c7c03-eea9-4c96-97cf-ad050007bfa4

- **user_id**: contains your Username used to connect to the messaging platform. This field will be used to apply security validation on the origin of messages sent to Elia.
I.e.: ISOEXT\DEMOMARKETPARTY1

Some other properties can be set to facilitate the interoperability of the platform, hereafter a non-exhaustive list:

- **content_type**: describes the content of the Body section of the message. It must be used with a value of: "application/json"
- **timestamp**: date/time of the creation of the message (UTC based)

The following properties should not be used:

- **expiration**: *do not setup* this property as messages are not supposed to have an automatic expiration date/time.

4.4.3 Header section

The header section can be used to store any information needed. The following header property is required:

- **conversation_id**: contains the unique identifier of the conversation. It allows the tracking of messages flows spans on more than one message exchange (= multiple correlation-id).
The first message sent in a new conversation must be assigned with a unique conversation_id.
This property must be propagated to every message part of the same exchange: this is the conversation. UUID based ID is recommended.
I.e.: a20c5c13-eea9-4c96-97cf-ad050007bfa4

As a summary, a message conversation is:

- one unique conversation_id,
- one or more correlation_id, depending on the number of "request-reply" scenario involved in the conversation,
- one or more message_id, depending on the number of messages needed for the exchange.

4.4.3.1 Example of message_id, correlation_id and conversation_id properties

The description of each message exchange contains a sequence diagram with all messages involved. The following rules must be applied to each sequence:

- Each message of the sequence must have a unique message_id
- All messages of the sequence must have the same conversation_id
- Every new message submitted must have a unique correlation_id
- Every answer or acknowledge must use the same correlation_id of the message that is being answered or acknowledged

The following example shows a sequence diagram and the use of message-id, conversation-id and correlation-id:

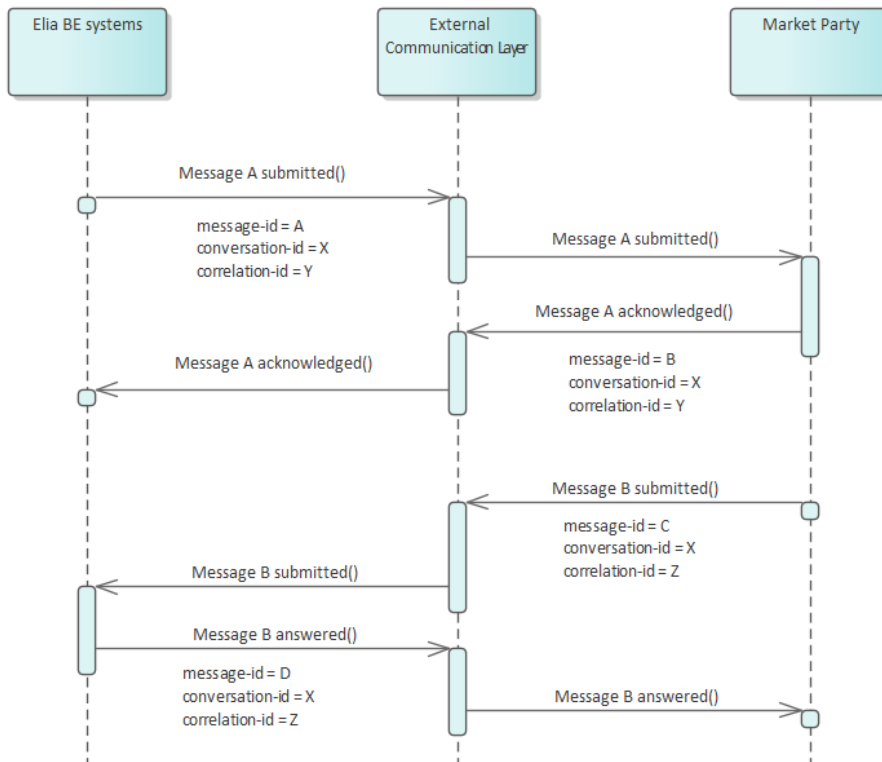

4.4.4 Body

The body of each message contains a MarketDocument in JSON format.

A specific section of this document details the general JSON structure expected in the body of the message.

The specific details of each MarketDocument are described later in this guide.

4.4.5 Sending a message

Sending a message to Elia is done by writing a specific message (and its metadata: header and properties) to the specified Exchange. The message is sent as soon as the write operation is committed.

4.4.6 Receiving a message

Receiving a message from Elia is performed by reading the message from the queue and by confirming the operation. The message will be removed from the queue only after the read operation is confirmed ('Ack'). There is no mechanism foreseen for the Market Parties to request the resent of messages that have already been read and confirmed.

5 Generic message specifications

5.1 JSON format and date format

5.1.1 JSON format

The body of all messages created in the framework of a data exchange must be written in Javascript Object Notation (JSON). This section contains a basic introduction to JSON documents and their structure.

5.1.1.1 JSON Overview

JSON (JavaScript Object Notation) is a text-based and human-readable syntax for storing and exchanging data between applications.

The Media Type is: **application/json**

5.1.1.2 A well formatted message

All elements in the JSON message must be correctly delimited. The use of properly nested start character “{” and end character “}” (in simple values, arrays and objects) is essential if the JSON message is to be read and interpreted correctly.

For example, the following element is correctly delimited:

```
{ "position": 20 }
```

The name of the root element must be present in the JSON message.

For example, for a message of type Acknowledgement_MarketDocument:

```
{
  "Acknowledgement_MarketDocument": {
  ....
  ....
  ....
  }
}
```

In this example, the block “Acknowledgement_MarketDocument” is the root of the message and contains all fields as described in the message specification.

Note! Each element must respect the indicated lower case or upper case letters.

5.1.1.3 Data types

The following table describes all datatypes allowed in JSON structure specifications that are used in the External Communication Layer:

Data type	Description	Lexical pattern
Number (int)	Represented in base 10 number system. No decimals allowed. No separators are allowed.	[+]?[0-9]+

	It can support negative values. Example: <pre>{ "position": 20 } { "volume": -5 }</pre>	
Number (decimal)	Represented in base 10 number system. Decimal characters allowed, separated by a point. No other separators allowed. It can support negative values. Example: <pre>{ "volume": 25.23 }</pre>	<code>[-+]?[0-9]+(\.[0-9]+)?</code>
String	Sequence of zero or more characters. Must be written in double quotes. Example: <pre>{ "company": "Elia" }</pre>	<code>.*</code>
Boolean	It can be either true or false Example: <pre>{ "result": true } { "result": false }</pre>	<code>true false</code>
Null	Indicates that there is no value Example: <pre>"value": null</pre>	<code>null</code>
Object	It is an unordered set of fields and values. Surrounded by curly braces {} Example: <pre>{ "Person": { "name": "Peter", "age": 20 } }</pre>	
Array	It is an ordered collection of values. Surrounded by brackets [] Example: <pre>{ "Point" : [{ "id": 123}, { "id": 124}, { "id": 125}] }</pre>	
White space	It can be inserted between two different tokens in order to facilitate readability. Example: <pre>{ "name": "Peter" } { "name": "Peter" }</pre>	

Formatted: English (United States)

Formatted: English (United States)

5.1.1.4 A valid message

In order to be understood, a JSON file must follow a predefined structure. The structure of the message is set out in a "Schema".

A JSON schema specifies the structure of JSON data. It is based on the concepts from XML Schema (XSD), but is JSON-based.

For example, if one of the mandatory elements in the schema is missing then the message is termed "invalid": it does not comply with the Schema. An invalid message will always be rejected by Elia systems.

5.1.1.5 A correct message

The fact that your JSON message is “valid”, does not necessarily mean that it is “correct” in terms of specifying your intended message. Not all the requirements of the JSON message can be defined simply in terms of the elements it contains.

For this reason, every message is subject to a number of “business” validation rules that must be applied and that are not controlled by the Schema.

In some cases Elia applies specific constraints on the messages that it will accept. For example, if Elia only accepts a certain set of values in a string field.

Details on these rules are given in the definition of each message.

5.1.2 Dates and times

5.1.2.1 Format

All dates and datetimes must be expressed in Coordinated Universal Time (UTC) with the format: “YYYY-MM-DDThh:mm:ssZ” (ISO-8601 extended format)

Where

- YYYY refers to the year,
- MM refers to the month
- DD refers to the day
- T is a fixed entry and indicates the start of the time definition
- hh refers to the hour
- mm refers to the minutes
- ss refers to the seconds
- Z is a fixed entry indicating that the Time Coordinate is UTC.

Example 1: 2020-05-10T13:00:00Z means then 10th of May 2020 at 15h in Belgian Summer local time

Note! DateTimes values are written in the JSON message as string data type.

5.1.2.2 Daylight saving time

The daylight saving times (DST) issue is solved by the use of UTC time. However, the sender of a message must include the correct amount of time intervals for each case.

Example 1: summer time to winter time in Belgium in 2020.

ISO	Local time	UTC
2020-10-25 00:00+02	0h	2020-10-24T22:00Z
2020-10-25 01:00+02	1h	2020-10-24T23:00Z
2020-10-25 02:00+02	2h	2020-10-25T00:00Z
2020-10-25 02:00+01	at 3h it is 2h	2020-10-25T01:00Z
2020-10-25 03:00+01	3h	2020-10-25T02:00Z

Example 3: winter time to summer time in Belgium in 2020.

ISO	Local time	UTC
2020-03-29 00:00+01	0h	2020-03-28T23:00Z
2020-03-29 01:00+01	1h	2020-03-29T00:00Z
2020-03-29 03:00+02	at 2h it is 3h	2020-03-29T01:00Z
2020-03-29 04:00+02	4h	2020-03-29T02:00Z

5.2 Market document structure

The format of all messages described in this document is specified with a MarketDocument.

A MarketDocument is a definition of a message body, which contains the following main elements: header, timeseries, periods and points.

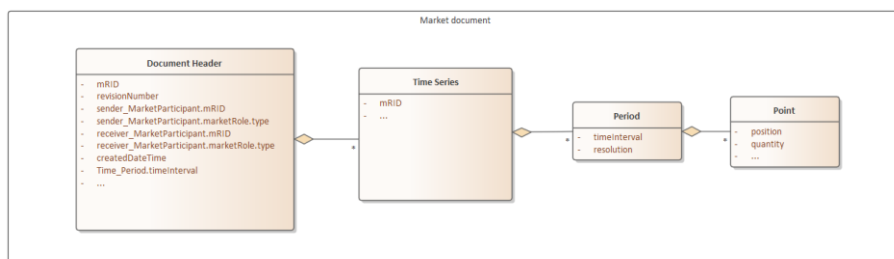

5.2.1 Header

It corresponds to a MarketDocument and contains an identification of the document (mRID = master Resource Identifier), a revision number, information about sender and receiver, and a list of timeseries.

A document is defined for a certain time interval with a start and end datetime.

It contains other fields that may be specific for each MarketDocument.

5.2.2 Timeseries

Timeseries can contain periods with a start and end date.

It contains other fields that may be specific for each timeseries.

The identification of the timeseries (mRID) must be unique within the message.

5.2.3 Period

It is a period of a timeseries with a start and end datetime. This period must be included in the time interval defined in the header.

It contains a list of Points.

The field “resolution” indicates the length (in minutes) of the points.

5.2.4 Point

The number of points must be in line with the duration of the Period.

Field “position” is a sequential field (integer) that indicates the position of the point in the period. It starts from 1.

It contains other fields that may be specific for each MarketDocument.

5.3 Identification and versioning

5.3.1 Identification

The header of each MarketDocument used for communication contains an identifier “mRID” and a version number “revisionNumber”.

The mRID of the market document must be unique. UUID based ID is recommended.

5.3.2 Updates

For any update, the same “mRID” must be used, with a higher “revisionNumber”. This message will **completely replace** any existing information of the previous version of this MarketDocument. Note however that Elia will **only take into account current and future values** of sent information, unless explicitly stated otherwise. This includes the ongoing time interval. When updates are sent with only the latter of the day, not sending the current time interval will be considered as an update (removal) of the current time interval information.

For example an initial submission of a document will have an identifier and a revision number equal to 1:

```
{
  "Example_MarketDocument": {
    "mRID": "4e7791aa-df87-4cac-9ee7-3d6c218a0579",
    "revisionNumber": 1

    ...
    <other contents of the message>
    ...
  }
}
```

Any update of the elements contained in the previous message will require a same identifier “mRID”, and a higher revision number:

```
{
  "Example_MarketDocument": {
    "mRID": "4e7791aa-df87-4cac-9ee7-3d6c218a0579",
    "revisionNumber": 2

    ...
    <other contents of the message>
    ...
  }
}
```

```
}

```

After the update, all elements contained in revision 1 of the documents are no longer valid so next to the changed element, elements that are not changed must be sent in again.

Depending on the information flow, it is necessary to explicitly **cancel** either a MarketDocument or a specific timeseries. Same as for updates, this must be communicated using the same MarketDocument mRID but accompanied by a new revision number. As this replaces the last received MarketDocument, other (un)changed timeseries must be sent in as well.

The following example shows what has to be (re)sent in the market document

1. Intial version
2. Deletion of timeseries C
3. Update of timeseries B
4. Update of timeseries A

What needs to be sent:

	Market Document X v1	Market Document X v2	Market Document X v3	Market Document X v4
Timeseries mRID	A B C	A B C (delete)	A B (update) C (delete)	A (update) B (update) C (delete)

In all cases, the latest MarketDocument holds the entire set of correct information.

5.3.3 Update frequency

Elia is expecting a frequency of one update for each Market Party per quarter hour on average. Elia reserves the right to limit this update frequency due to technical constraints.

5.4 Message granularity

The content of each message is defined by the granularity of its respective object. The object will thus determine the split of information into different messages.

Granularity is specified in the description of each message.

6 Acknowledgement and answer messages

All messages submitted by Elia or by a Market Party will require at least one response message. The need and the format of each response message is described for each message flow.

There are two different kind of responses: acknowledgements and answers.

Acknowledgement and answer messages cannot be responded with any other acknowledgement or answer message. In case an acknowledgement or answer does not respect the rules defined, they will be placed in the corresponding error queue.

6.1 Acknowledgement

For all messages sent by Elia to a Market Party, a proof of reception of a message is required.

This is a message with a name "Acknowledged" (for example, ActivationAcknowledged). This type of message is specified with an [Acknowledgement MarketDocument](#).

Fields "received_MarketDocument.mRID" and "received_MarketDocument.revisionNumber" must correspond to the mRID and revisionNumber of the MarketDocument that is being acknowledged. If this information is not correct, the acknowledgement is invalid.

Once an acknowledgement message is sent with no errors, no more acknowledgements to the same MarketDocument are expected.

Note: Elia will not send acknowledgement messages. A Market Party can consider a message as delivered once the write operation has succeeded (more information about sending a message can be found in the description of the External Communication Layer).

6.1.1 Message description

Acknowledgement_MarketDocument (exactly one element per message)		
Field	Mandatory	Description
mRID	Y	Unique identifier for the MarketDocument
type	Y	Code for type of the MarketDocument A17 = Acknowledgement Document
createdDateTime	Y	The timestamp on which the message was sent
sender_MarketParticipant.mRID	Y	The identification of the sender (EIC code)
sender_MarketParticipant.marketRole.type	Y	The role code associated with the sender Z02 = Scheduling Agent A46 = Balancing Service Provider Z03 = Outage Planning Agent
receiver_MarketParticipant.mRID	Y	The identification of the receiver (EIC code)
receiver_MarketParticipant.marketRole.type	Y	The role code associated with the receiver A04 = System Operator
received_MarketDocument.mRID	Y	The MarketDocument identification (mRID) to which is acknowledged
received_MarketDocument.revisionNumber	Y	The MarketDocument revision number to which is acknowledged. If the Market Document being acknowledged does not have a revision number, 1 should be used here.
Reason	Y	Indicates a status for the acknowledgement.

Field Code Changed

		This list that can only contain one element.
--	--	--

Reason		
Field	Mandatory	Description
code	Y	The code that represents the acknowledgement A01 = Accepted 999 = Rejected (only allowed in case of technical error)

6.2 Answer

For all messages sent by a Market Party to Elia, Elia will send a functional answer after the validation and process of an incoming message.

These are messages with a name "Answered" (for example, ActivationRequestAnswered). This type of message is specified with a [Confirmation_MarketDocument](#).

Fields "confirmed_MarketDocument.mRID" and "confirmed_MarketDocument.revisionNumber" must correspond to the mRID and revisionNumber of the message that is being answered. If this information is not correct, the confirmation message is invalid.

Elia will perform a technical validation and a functional validation of each message received and add the validation result details (validation status and possible errors or warnings) in the answer message.

The technical and functional validation rules are described in this document.

Note: the answer message is only sent once the original request (message that is being answered) has been fully processed.

6.2.1 Message description

Confirmation_MarketDocument (exactly one element per message)		
Field	Mandatory	Description
mRID	Y	Unique identifier for the market document.
type	Y	Code for type of the MarketDocument. A18 = Confirmation report
sender_MarketParticipant.mRID	Y	The identification number of the sender (EIC code). The value must be 10X1001A1001A094 = Elia
sender_MarketParticipant.marketRole.type	Y	The role code associated with the sender A04 = System Operator
receiver_MarketParticipant.mRID	Y	The identification ID of the receiver (EIC code).
receiver_MarketParticipant.marketRole.type	Y	The role code associated with the receiver Z02 = Scheduling Agent A46 = Balancing Service Provider Z03 = Outage Planning Agent
createdDateTime	Y	The timestamp on which the confirmation message was sent
confirmed_MarketDocument.mRID	Y	mRID of the MarketDocument that is being replied
confirmed_MarketDocument.revisionNumber	Y	revisionNumber of the MarketDocument that is being replied

Field Code Changed

Reason	Y	List with reasons associated to the MarketDocument It indicates the response status of the message
Confirmed_TimeSeries	N	The timeseries replied to. It contains a status for each timeseries of the MarketDocument that is being replied. In case the answer contains error on MarketDocument level, this list will be empty

Confirmed_TimeSeries		
Field	Mandatory	Description
mRID	Y	mRID of the timeseries replied to
Reason	Y	This list that can only contain one element with the reason associated to the timeseries

Reason		
Field	Mandatory	Description
code	Y	<p>For Confirmation_MarketDocument: A01 = Message fully accepted Y99 = Message is waiting for confirmation Y98 = Message accepted with warnings A02 = Message fully rejected</p> <p>In case of error (A02) or waiting for confirmation (Y99) in MarketDocument level, a second reason will include the reason code described in the validation rules</p> <p>For accepted Confirmed_TimeSeries: B06 = Accepted</p> <p>For accepted with warning Confirmed_TimeSeries: This is the warning reason code described in the validation rules</p> <p>For rejected Confirmed_TimeSeries: This is the error reason code described in the validation rules</p> <p>For waiting for confirmation Confirmed_TimeSeries: This is the reason code described in the validation rules</p>
text	Y	The text associated with the status code

7 Notification messages

7.1 Description

This notification allows to notify Market Parties of certain events. The message itself is generic and the reason indicates the event that happened. This message type can be used for a range of different notifications and can be contextualized via associated objects. Even though the notifications can be of a very different nature, this standardized message allows automatic processing. Note that the same notifications can be offered via email depending on the preference of communication of the concerned Market Party.

The catalog of the notifications and the associated objects types that will give them context will be exposed via a webclient where they can be consulted.

An acknowledgement message will be expected after the reception of the notification message.

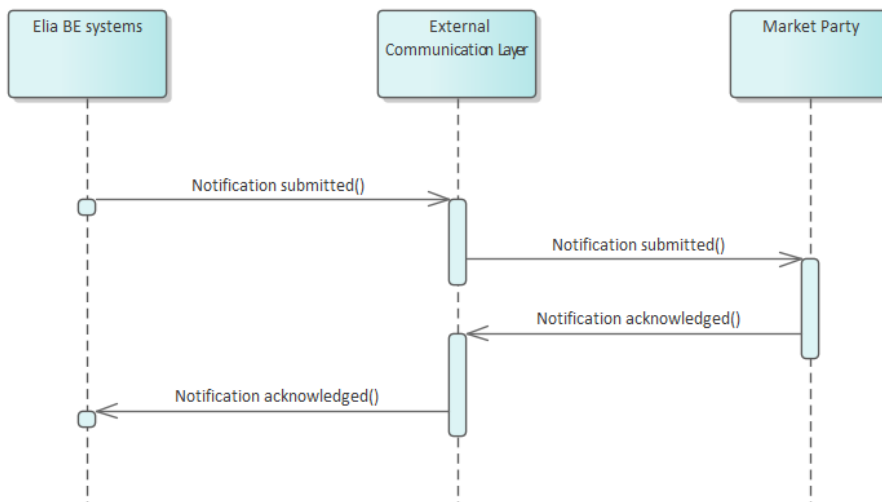

7.2 Notification submitted message

7.2.1 Message granularity

The message granularity will depend on the notification. It will include one or more objects for a specific notification.

7.2.2 Message timeframe

Dependent on type of notification.

7.2.3 Message description

A document [Notification MarketDocument](#) is used for the notification.

Optional fields of the market document that are not described in this chapter cannot be used.

Field Code Changed

Notification_MarketDocument (exactly one element per message)		
Field	Mandatory	Description
mRID	Y	Unique identifier for the message
revisionNumber	Y	Version number for the MarketDocument
type	Y	Z05 = Notification report
sender_MarketParticipant.mRID	Y	The identification ID of the sender (EIC code). Fixed value: 10X1001A1001A094 = Elia
sender_MarketParticipant.marketRole.type	Y	The role code associated with sender. Fixed value: A04 = System Operator
receiver_MarketParticipant.mRID	Y	The identification number of the receiver (EIC code)
receiver_MarketParticipant.marketRole.type	Y	The role code associated with receiver Z02 = Scheduling Agent A46 = Balancing Service Provider Z03 = Outage Planning Agent
createdDateTime	Y	The timestamp on which the message was sent
Reason	Y	This list can only contain one element
PrimaryObject	N	List of a Primary Object Type & Object instances related to the notification reason

PrimaryObject		
Field	Mandatory	Description
type	Y	Type of object. The potential objects types that can be used will be communicated at a later time
value	Y	Id or value of the object for a specific object type. Can be a date, an EAN code, Bid Group Id, ...
SecondaryObject	N	List of Secondary Object types & Object instances related to an existing primary object. Only used for notifications that use nested objects.

SecondaryObject		
Field	Mandatory	Description
type	Y	Type of object. The potential objects types that can be used will be communicated at a later time
value	Y	Id or value of the object for a specific object type. Can be a date, an EAN code, Bid Group Id, ...

Reason		
Field	Mandatory	Description
code	Y	The code that represents the notification. The potential codes that can be used will be communicated at a later time
text	Y	The notification text. This can be missing information or the detection of a forced outage for example. The exhaustive list will be published at a later time

7.3 Notification acknowledged message

7.3.1 Message granularity

An acknowledgement must be sent for each notification message received.

7.3.2 Message timeframe

The acknowledgement message must be sent at the moment of the reception of the notification message

7.3.3 Message description

As described in the definition of acknowledgement message (see [Acknowledgement and answer messages](#)).

Field Code Changed

8 Outage Planning Agent Guide

8.1 Role overview

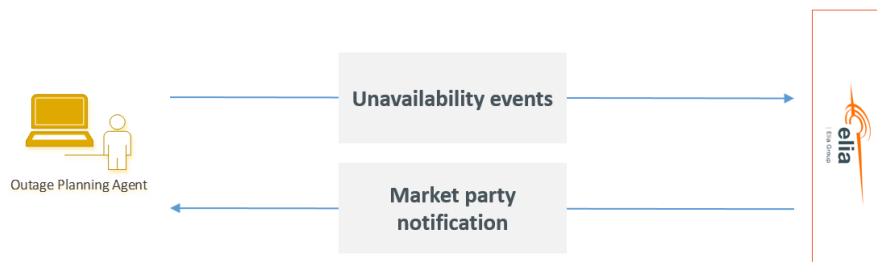

An outage planning agent is involved in the following communications:

- Submission of unavailability events
- Market Party notifications sent by Elia

8.2 Submitting unavailability events

8.2.1 Description

In phase 1 of iCAROS, the availability plan will be constructed using the availability statuses from the Ready to Run procedure (old data exchange flows NOT described in this technical guide) and updates based on unavailability events (new data exchange described in this technical guide) that indicate a (partial) unavailability due to a test event or a Planned or a Forced Outage.

The technical guide describes only the new information exchange that can take place from the end of the RTR procedure onwards. From then onwards, the Outage Planning Agent shall send in an unavailability event in case of an occurrence or modification of a test event or Planned Outage, which is subject to manual Elia validation, and the communication of a Forced Outage which is subject to automatic validation. Once the message is processed, a confirmation message will be sent back to the Outage Planning Agent.

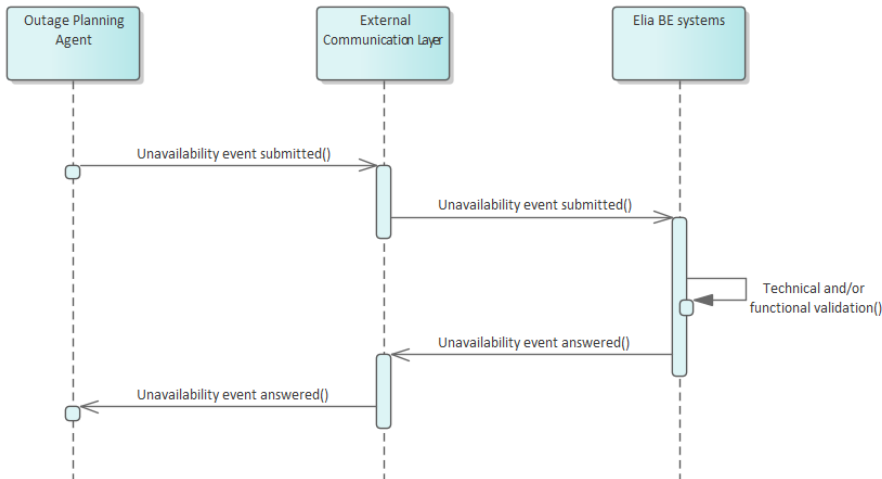

8.2.2 Queue information

This table contains the queues and exchanges to send and receive messages in a normal scenario:

Message Type	Description	Sender	Receiver	Queue/Exchange
Unavailability event Submitted	Submission of new unavailability event or unavailability event update	OPA	Elia	UnavailabilitySubmitted.In.Exch
Unavailability event Answered	Answer to a unavailability event message	Elia	OPA	UnavailabilityAnswered.[TargetMarketPartyID].OutQ

Error queues

This table contains the queues and exchanges to send and receive message only in case of error:

Message Type	Sender	Receiver	Queue/Exchange
Unavailability event Submitted	Elia	OPA	UnavailabilitySubmitted.[TargetMarketPartyID].ErrorQ
Unavailability event Answered	OPA	Elia	UnavailabilityAnswered.Error.Exch

8.2.3 Unavailability event submitted message

8.2.3.1 Message granularity

For unavailability events, the granularity is set at the **delivery point** and **unavailability event**. Meaning that for each combination of these objects, we expect exactly one single message per sent version.

8.2.3.2 Message timeframe

The following image shows the transitory solution for iCAROS phase 1 where we keep the long term availability planning based on AS IS data exchange (not described in this technical guide) whereas the information provided up to then through the old data exchange is combined with information sent in through unavailability events (described here), in order to construct a quarter-hourly availability plan.

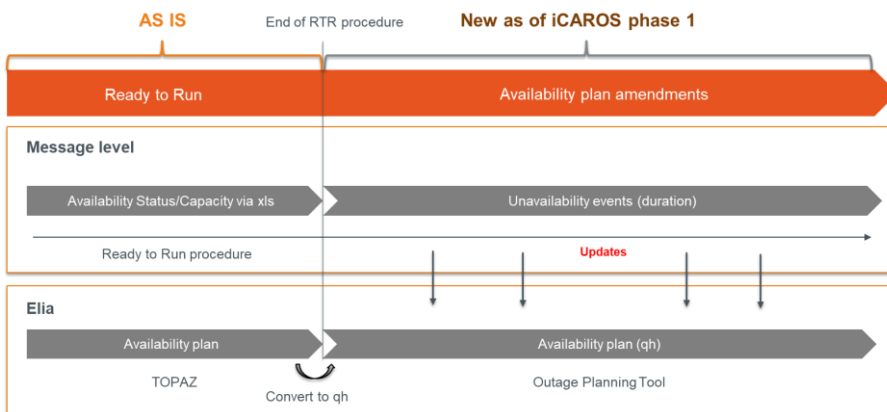

The status coming from Ready-To-Run procedure (old data exchange not described in this technical guide) will be automatically translated when the RTR procedure ends into an availability plan with a status for all quarter-hours (see conversion table below).

Status in Ready-To-Run procedure	Automatic translation at the end of the RTR procedure
NRR - Not Ready to Run	Unavailable
RR - Ready to Run	Available
RRR - Ready to Run Reserved	Available
MNRR - May Not Ready to Run	Unavailable

When availability plans are generated based on the Ready-To-Run procedure, the new exchange will allow updates of the availability plan by mapping the unavailabilities. The following image shows some potential scenarios.

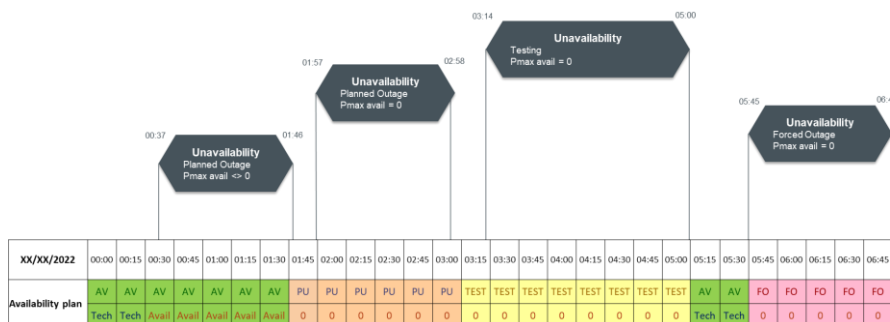

Note that it is allowed to communicate an unavailability end date that lies further than D+7 (through the new exchange), which means there might be an overlap with the communication done afterwards in the Ready-To-Run procedure (through the old exchange). This information is expected to be coherent. If it is not, the information passed via the new exchange prevails.

8.2.3.3 Updates and withdrawals

As we will work with two information exchanges during phase 1 of iCAROS, the updates and withdrawals of unavailabilities deserves a specific mention.

In the timeframe after the RTR procedure in W-1, we expect only messages at the occurrence of an unavailability event or when an event is updated / withdrawn.

Update unavailabilities

To update unavailabilities, a Market Document including the TimeSeries block and the Available_Period block must be used.

We discern two scenarios:

- When an **unavailability status from the Ready-To-Run procedure must be updated** after this procedure is over, a new Market Document of version 1 must be sent via the new data exchange to cover the desired period to update.
- When an **unavailability event of the new exchange (described in this guide) must be updated**, the rules described in the generic section of this document on updating must be followed. The same Market Document with a new Revision Number must be used and will replace the previous version of that Market Document completely.

Withdrawing unavailabilities

To withdraw unavailabilities, a Market Document including the TimeSeries block but without the Available_Period block must be used and the docStatus should be set to “Withdrawn” (A13).

We discern two scenarios:

- When an **unavailability status from the Ready-To-Run procedure must be withdrawn** after this procedure is over, a new Market Document of version 1 must be sent via the new data exchange to cover the desired period to withdraw. This will be interpreted as clearing the unavailabilities communicated in the RTR procedure which will translate the availability plan statuses to 'Available' for the indicated period, with no capacity limitations. The period indicated in the MarketDocument cannot already contain an unavailability communicated via the new exchange. To withdraw the latter see the next bullet point.
- When an **unavailability from the new exchange (described in this guide) must be withdrawn**, the same Market Document with a new Revision Number is expected and the rules described in the generic section of this document must be followed.

8.2.3.4 Message description

A [Unavailability MarketDocument](#) is the message that must be used in order to submit the amendments to an availability plan.

Field Code Changed

Optional fields of the MarketDocument that are not described in this chapter cannot be used.

Unavailability_MarketDocument (exactly one element per message)		
Field	Mandatory	Description
mRID	Y	Unique identifier for the MarketDocument
revisionNumber	Y	Version number for the MarketDocument
type	Y	Code for type of MarketDocument. Z04 = Unavailability Document
process.processType	Y	Code for type of process. Z01 = Short term unavailability information
sender_MarketParticipant.mRID	Y	The identification of the sender (EIC code)
sender_MarketParticipant.marketRole.type	Y	The role code associated with the sender: Z03 = Outage Planning Agent
receiver_MarketParticipant.mRID	Y	The identification of the receiver (EIC code): 10X1001A1001A094 = Elia TSO
receiver_MarketParticipant.marketRole.type	Y	The role code associated with the receiver: A04 = System Operator
createdDateTime	Y	The timestamp on which the message was sent
unavailability_Time_Period.timeInterval	Y	The start and end date and time of the period to which the unavailability refers to
docStatus	N	Status only to be used to identify an unavailability document that has been cancelled. A13 = Withdrawn
TimeSeries	Y	This list can contain only one element.

TimeSeries		
Field	Mandatory	Description
mRID	Y	Sender's identification of the timeseries

businessType	Y	Identifies the nature of the unavailability event. The following CIM codes are used A53 = Planned Maintenance (Planned Unavailability) A54 = Unplanned Outage (Forced Outage) B83 = Testing
registeredResource.mRID	Y	The delivery point EAN representing the point for which the unavailability is sent
start_DateAndOrTime.date	Y	The date at which the unavailability event starts
start_DateAndOrTime.time	Y	The time at which the unavailability event starts
end_DateAndOrTime.date	Y	The date at which the unavailability event ends
end_DateAndOrTime.time	Y	The time at which the unavailability event ends
curveType	Y	A01 = Sequential fixed size block (default if no availability). Used when the available period is constructed using same resolution. A03 = Variable sized block. Used when the available period is constructed using different resolution.
quantity_Measure_Unit.name	Y	Expressed available capacity is in Megawatt. Fixed value: MAW
Reason	N	This list can contain two elements and allows additional free text information to contextualize the unavailability event.
Available_Period	N	This list allows 1 or more elements to compose periods with different intervals. Only optional in case of withdrawal.

Available_Period		
Field	Mandatory	Description
timeInterval	Y	The start and end date and time to which the available period refer to
resolution	Y	Amount of time for each interval in which a data value is defined. For example: PT1M = per minute PT15M = 15 minutes PT1D = 1 day
Point	Y	List of points associated to the period. It should contain as many points as needed to complete the period. If only 1 point is given, it is assumed that the same maximum available capacity is used for the entire period. This is a deviation from technical validation rules GEN_10 & GEN_11 allowed for outage planning.

Reason		
Field	Mandatory	Description
code	Y	The code that represents the reason A95 = Complementary information (additional information on the unavailability) or Y30 = Remarks (more detailed information on the event that allows a full understanding of its potential impact)

text	Y	Both codes allow free text
------	---	----------------------------

Point		
Field	Mandatory	Description
position	Y	The interval number defining which position in the period is indicated. It must start at 1.
quantity	Y	The maximum available capacity for the concerning position within the available period. This is the Pmax Available value that overrules the one specified in the Ready-to-Run..

timeInterval		
Field	Mandatory	Description
start	Y	The start date and time of the interval
end	Y	The end date and time of the interval

8.2.4 Validation of an unavailability event submitted message

This information flow will be subject to all generic validation rules. These and the validation rules listed in the table below are further described in the following section of this document: [Validation rules description](#).

ID	Validation Rule	Reply Status	Reason Code	Level
OPL_001	<u>Planned/testing unavailability's start date shouldn't be set in the past nor submitted before the closure of its related ready-to-run process</u>	Reject	Y27	MarketDocument
OPL_002	The unavailability start date should fall before current date + 12 for updates of planned unavailabilities	Reject	Y26	MarketDocument
OPL_003	The unavailability end date should lie after D-1	Reject	Y40	MarketDocument
OPL_004	The unavailability period of the MarketDocument must be the same as the period of the unavailability event	Reject	Y39	MarketDocument
OPL_005	The Delivery Point must be included in an OPA contract valid for the availability period for this Outage Planning Agent	Reject	Y76	Timeseries
OPL_006	Active unavailability event periods cannot overlap across Market Documents	Reject	Y38	MarketDocument
OPL_007	Planned unavailabilities need manual verification	Waiting for confirmation	Y37	Timeseries
OPL_008	The maximum available capacity should always be expressed in absolute values	Reject	Y107	MarketDocument
OPL_009	The unavailability start date should fall between D-1 and next QH after real time for new forced outages	Reject	Y109	MarketDocument
OPL_010	The updated start date of a forced outage should lie on the same day than the start date of the original forced outage	Reject	Y108	MarketDocument
OPL_011	Forced outage updates need manual verification when updated end date lies before current end date	Waiting for confirmation	Y110	MarketDocument

Field Code Changed

Deleted: Planned unavailability submitted before the unavailability start date's related ready-to-run process

Formatted: English (United States)

All unavailability events and updates are subject to manual validation by Elia except for Forced Outages.

8.2.5 Unavailability answered message

The answers to unavailability events are submitted by Elia and received by the OPA.

All unavailability event messages should be answered by Elia.

Note: no acknowledgement of an answer is supported

8.2.5.1 Message granularity

One confirmation message will be sent for each unavailability period submitted message sent by the OPA.

8.2.5.2 Message timeframe

The confirmation message will be sent as soon as the unavailability event message has been processed.

8.2.5.3 Message description

As described in the definition of answer message (see [Acknowledgement and answer messages](#)).

Field Code Changed

8.3 Receiving a Market Party notification

8.3.1 Description

This message exchange is described in the following section: [Notification messages](#).

Field Code Changed

8.3.2 Queue information

This table contains the queues and exchanges to send and receive messages in a normal scenario:

Message Type	Description	Sender	Receiver	Queue/Exchanges
Outage Planning Agent Market Notification Submitted	Submission of a Market Party notification	Elia	OPA	OutagePlanningAgentNotificationSubmitted.[TargetMarketPartyID].OutQ
Outage Planning Agent Market Notification Acknowledged	Reception confirmation of a Market Party notification	OPA	Elia	OutagePlanningAgentNotificationAcknowledged.In.Exch

Error queues

This table contains the queues and exchanges to send and receive message only in case of error:

Message Type	Sender	Receiver	Queue/Exchange
Outage Planning Agent Market	OPA	Elia	OutagePlanningAgentNotificationSubmitted.Error.Exch



Notification Submitted			
Outage Planning Agent Market Notification Acknowledged	Elia	OPA	OutagePlanningAgentNotificationAcknowledged.[TargetMarketPartyID].ErrorQ

9 Scheduling Agent Guide

9.1 Role overview

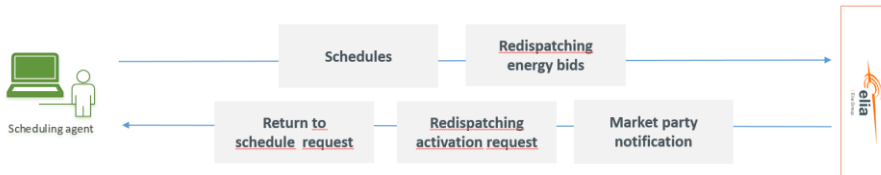

A Scheduling Agent is involved in the following communications:

- Submission of schedules
- Return-to-schedule requests
- Submission of redispatching bids
- Activation of redispatching bids
- Market Party notifications sent by Elia

9.2 Bid structure

This specific section aims to give some clarifications on how to construct Energy Bids.

A general rule is that all Energy Bids for a certain **execution date** and a certain **Providing Group** must be sent in a single message per sent version. An Energy Bid is defined for a particular quarter-hour and must be grouped into Bid Groups.



9.2.1 Bid groups

Energy Bids representing the **same or partly the same offered volume over consecutive quarter-hours** must be grouped into Bid Groups using a Bid Group Id on the corresponding Timeseries level of

the message. This grouping will technically link¹ the Energy Bids together in order to avoid unfeasible activations. The Energy Bids that are subject to mFRR and redispatching activations will be activated based on the Bid Group Id, the quarter hour of activation and the direction.

9.2.2 Timeseries

As in each CIM message, the Timeseries block is used as a parent level in the message structure and encapsulates the periods and points (representing the actual Energy Bids across time). As long as the attributes on Timeseries level are applicable for the underlying QH bids of a Bid Group, there is no need to split the Timeseries blocks.

Note however that for Bid Groups that are not split in different Timeseries blocks during the execution date, a technical link is necessary between different messages if the Energy Bids that are consecutive across midnight represent (partly) the same volume. In this case, the same Bid Group Id must be used in these different messages.

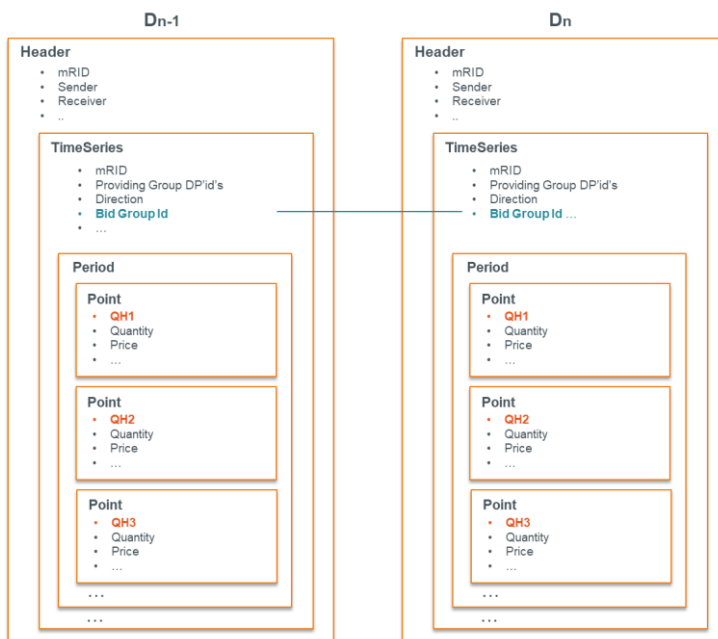

¹ Energy Bids that are part of a same Bid Group/that have the same Bid Group ID will be technically linked so that the activation of a bid will be prevented in case the technically linked bid of the previous QH was activated in Direct Activation.

When attributes on Timeseries level are different for certain periods during the execution date of a same Bid Group, the Timeseries block can be split into multiple block(s) so that the necessary attributes can be applied to the respective period(s) of the day.

Note that in this case, a technical link is necessary between different messages **and** between Timeseries blocks of the same message for consecutive QH bids that represent (partly) the same volume.

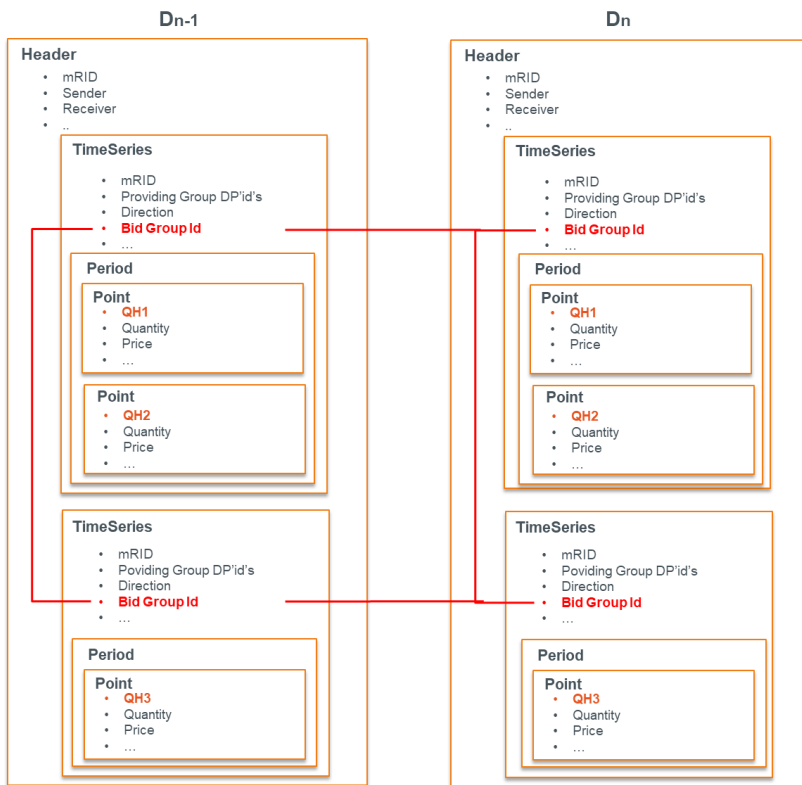

9.2.3 Linking

Exclusive and parent child linking apply to bids of the same quarter hours. This linking must be done in a similar way to Bid Grouping, using the respective attribute (exclusiveBidsIdentification; multipartBidIdentification) on the different timeseries blocks that need to be linked.

.For conditional linking, which like technical linking applies to different quarter hours, it is necessary to use the LinkedBid Timeseries block. In this block you can define the Bid Group Id to which the conditional link relates, the status and the level.

The levels will determine the amount of quarter hours linked to in time. Level 1 links to the previous quarter hour and level 2 to two quarter hours before. As the link is done on Bid Group level, they apply to all quarter hour bids that can be linked in time between the two Bid Groups.

In the following you can see two conditional links that are representing respectively level 1 and level 2 QH linking.

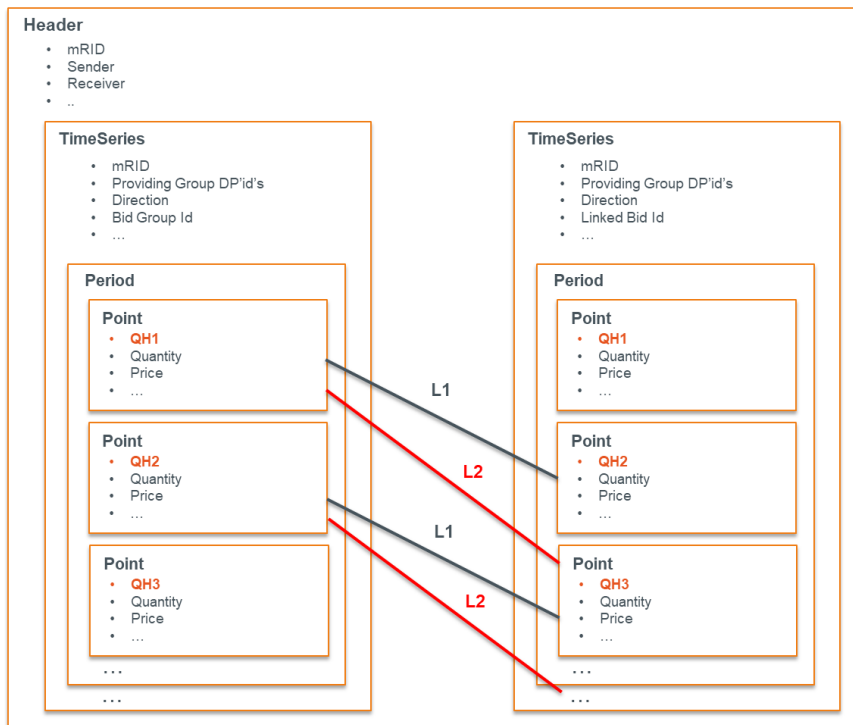

9.2.4 Delivery Points

A Providing Group comprises any set of Delivery Points that can be offered together in an Energy Bid. The bid structure allows to define the Delivery Points (DPs) to which the bids relate to at three levels. All bids inherit the Delivery Points identified in the Providing Group unless a deeper level is used to identify Delivery Points. The same goes for Bid Group and Bid level where, if Delivery Points are identified in the latter, the Point Group (bid) Delivery Points will be used.

1. **Providing Group level:** all Delivery Points used for bids within the message must always be defined at Providing Group level.



→ Bids of Bid Group 1 & 2 are based on Providing Group DPs

2. **Bid Group level:** when Delivery Points are identified on Bid Group level, they only relate to the bids defined within this Bid Group. This level is useful to bid on different operating modes for example.

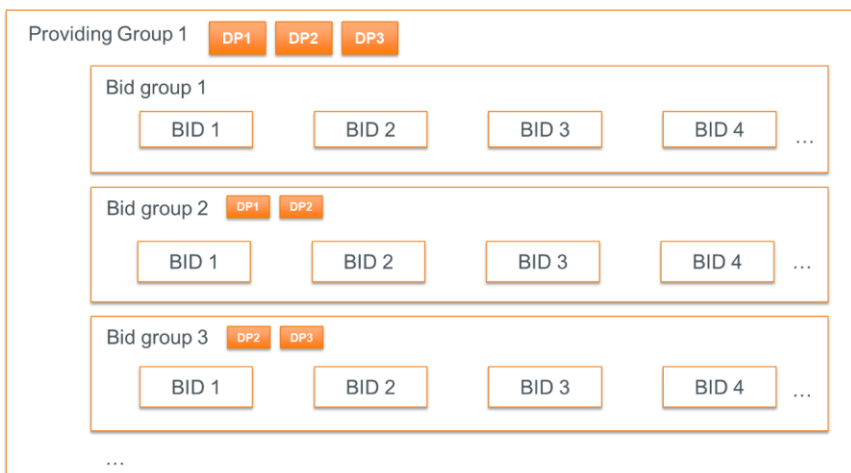

→ Bids of Bid Group 1 are based on Providing Group DPs

→ Bids of Bid Group 2 & 3 are based on their respective DPs

3. **Bid level:** when the Delivery Points are identified on Bid (Point Group) level, they apply to a specific bid. This level can be used to change the composition of the Delivery Points for (a/some) specific quarter hour(s) of a Timeseries block without having to split it.



- Bid 1 to Bid 4 relate to DPs specified on those bids
- Bid 5 onwards relate to Providing Group DPs

9.3 Submitting schedules

9.3.1 Description

This information flow describes the process of schedule submission which is required for each delivery point included in a scheduling contract.

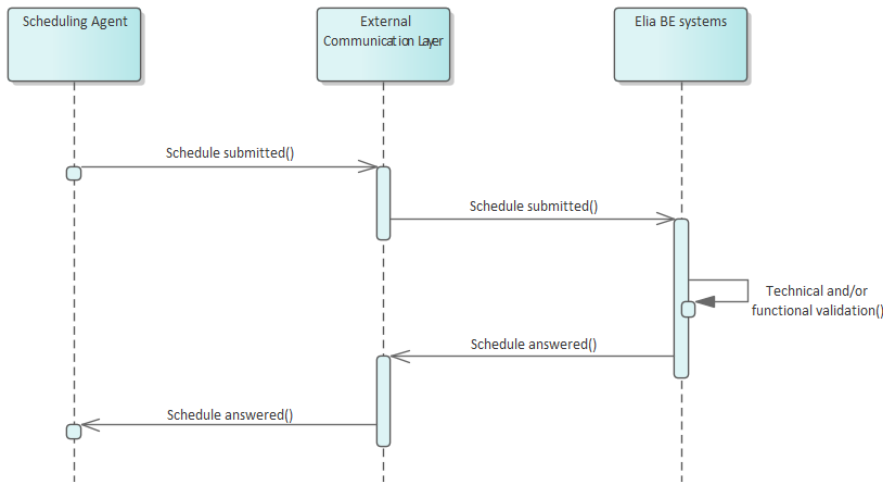

Schedules can be sent and updated via a schedule submitted message. The External Communication Layer will treat the message in an asynchronous manner and will reply to it with the result of the validation done in the Elia backend systems.

9.3.2 Queue information

This table contains the queues and exchanges to send and receive messages in a normal scenario:

Message Type	Description	Sender	Receiver	Queue/Exchange
Schedule Submitted Message	Submission of new schedule or schedule update	SA	Elia	ScheduleSubmitted.In.Exch
Schedule Answered Message	Answer to a schedule submitted message	Elia	SA	ScheduleAnswered.[TargetMarketPartyID].OutQ

Error queues

This table contains the queues and exchanges to send and receive message only in case of error:

Message Type	Sender	Receiver	Queue/Exchange
Schedule Submitted	Elia	SA	ScheduleSubmitted.[TargetMarketPartyID].ErrorQ
Schedule Answered	SA	Elia	ScheduleAnswered.Error.Exch

9.3.3 Schedule submitted message

9.3.3.1 Message granularity

For scheduling, the granularity is set at the **delivery point** and the **schedule execution date** (full or remainder of timeseries) level. Meaning that for each combination of these objects, we expect exactly one single message per sent version.

9.3.3.2 Message timeframe

To allow the right context, the timeframe in which the schedules are expected is described here. Note however that the exact timings are described in the contract of which the information always prevails.

- Schedules must be sent before D-1 15h
- Schedules can be updated until T - 45 min on execution date (Redispatching GCT)
- There is a standstill period between D-1 15h and D-1 18h. Schedules received within this period will only be processed when the standstill period ends.



9.3.3.3 Message description

A [Schedule_MarketDocument](#) is the message that must be used in order to submit the schedules.

Optional fields of the MarketDocument that are not described in this chapter cannot be used.

Field Code Changed

Schedule_MarketDocument (Exactly one element per message)		
Field	Mandatory	Value(s)
mRID	Y	Unique identification of the market document (UUID)
revisionNumber	Y	Version number for the market document
type	Y	Type of market document. Fixed value: Z02 = Active Power Schedule Document
process.processType	Y	Code for type of process: A17 = Schedule day
process.classificationType	Y	Defines whether the schedule is an aggregation or a classification. Fixed value: A01 = detail type
sender_MarketParticipant.mRID	Y	The identification of the sender (EIC code)
sender_MarketParticipant.marketRole.type	Y	The role code associated with sender: Z02 = Scheduling Agent
receiver_MarketParticipant.mRID	Y	The identification of the receiver (EIC code). Fixed value: 10X1001A1001A094 = Elia
receiver_MarketParticipant.marketRole.type	Y	The role code associated with receiver. Fixed value: A04 = System Operator
createdDateTime	Y	The timestamp on which the message was sent
schedule_Time_Period.timeInterval	Y	The start and end date and time of the day to which the schedule refers to (execution date)

domain.mRID	Y	10YBE-----2 = Belgian bidding zone
TimeSeries	Y	This list only allows 1 element

TimeSeries		
Field	Mandatory	Value(s)
mRID	Y	Sender's identification of the timeseries.
version	Y	Fixed value: 1
businessType	Y	Identifies the trading nature of the timeseries: Z12 = Net Consumption - Production
product	Y	The energy product of the schedule timeseries. Fixed value: 8716867000016 = active power
objectAggregation	Y	Identifies how the object is aggregated. Fixed value: Z01 = Delivery Point
registeredResource.mRID	Y	The delivery point EAN representing the point for which the schedule is sent
measurement_Unit.name	Y	MAW = expressed scheduled power is in Megawatt
Period	Y	This list only allows 1 element

Period		
Field	Mandatory	Value(s)
timeInterval	Y	The start and end date and time to which the schedule timeseries refer to
resolution	Y	Amount of time for each interval in which a data value is defined. Fixed value: PT15M = 15 minutes
Point	Y	List of points associated to the period. It should contain as many point as needed to complete the period.

Point		
Field	Mandatory	Value(s)
position	Y	The interval number defining which position in the timeseries is indicated. It must start at 1.
quantity	Y	The list of schedule intervals in which the value (MW) of the scheduled power is given. We require an accuracy of 0.1 MW.
Reason	N	This list that can only contain one element. Only used in case of a schedule update because of forced outage.

timeInterval		
Field	Mandatory	Value(s)
start	Y	The start date and time of the interval
end	Y	The end date and time of the interval

Reason		
Field	Mandatory	Value(s)
code	Y	Y24 = Forced Outage

9.3.4 Schedule answered message

The schedule answers messages are sent by Elia and received by the SA.

All Schedule submitted messages are answered by Elia with a schedule answered message.

Note: no acknowledgement of an answer is supported

9.3.4.1 Message granularity

One Schedule answer will be sent for each schedule submitted message sent by the SA.

9.3.4.2 Message timeframe

The confirmation message will be sent as soon as the schedule submitted message has been processed.

9.3.4.3 Message description

As described in the definition of answer message (see [Acknowledgement and answer messages](#)).

Field Code Changed

9.3.5 Validation of a schedule submitted message

This information flow will be subject to all generic validation rules. These and the validation rules listed in the table below are further described in the following section of this document: [Validation rules description](#).

Field Code Changed

ID	Validation Rule	Reply Status	Reason Code	Level
SCH_001	Redispatching GCT must be respected	Reject	A57	MarketDocument
SCH_002	Scheduled power must be within technical capacity	Accept with warning	Y92	Timeseries
SCH_003	The Delivery Point must be included in an SA contract valid on the execution date for this Scheduling Agent	Reject	Y91	Timeseries
SCH_004	The MW schedule must be expressed in one fraction digit	Reject	Y90	Timeseries
SCH_005	A schedule cannot be updated in the opposite direction of a redispatching activation on the same period	Reject	Y89	Timeseries
SCH_006	Incremental update requested during a storm is subject to manual validation.	Waiting for confirmation followed by accept or reject message	Y88	Timeseries
SCH_007	Update requested in violation with a Must Run or May Not Run status is not allowed.	Reject	Y87	Timeseries
SCH_008	The MarketDocument time period must exactly cover the full calendar day	Reject	Y86	MarketDocument
SCH_009	The schedule is received within the standstill period	Waiting for confirmation followed by accept or reject message	Y23	MarketDocument

SCH_010	A schedule must always cover a complete calendar day	Reject	Y13	MarketDocument
SCH_011	Schedule reverted due to incoherency with Redispatching bid	Reject	Y12	MarketDocument

9.4 Receiving a return to schedule request

9.4.1 Description

The return to schedule interface describes the way Elia will send out return-to-schedule commands towards the Scheduling Agent. Elia will send an asynchronous message to request a return to schedule to the SA. The SA will generate an acknowledgement indicating the good reception of the activation message

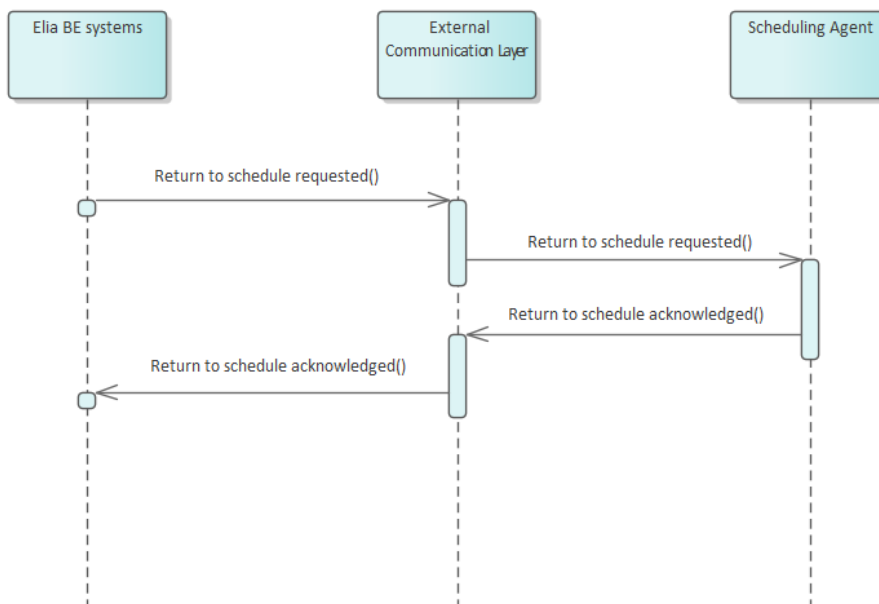

9.4.2 Queue information

This table contains the queues and exchanges to send and receive messages in a normal scenario:

Message Type	Description	Sender	Receiver	Queue/Exchange
Return to schedule requested	Submission of a request of return to schedule	Elia	SA	ReturnToScheduleRequested.[TargetMarketPartyID].OutQ
Return to schedule acknowledged	Confirmation of reception of the return to schedule request	SA	Elia	ReturnToScheduleAcknowledged.In.Exch

Error queues

This table contains the queues and exchanges to send and receive message only in case of error:

Message Type	Sender	Receiver	Queue/Exchange
Return to schedule requested	SA	Elia	ReturnToScheduleRequested.Error.Exch
Return to schedule acknowledged	Elia	SA	ReturnToScheduleAcknowledged.[TargetMarketPartyID].ErrorQ

9.4.3 Return to schedule requested message

9.4.3.1 Message granularity

The object of the message is defined at **Scheduling Agent** level, including all the **Delivery Points** that are requested to return to schedule.

9.4.3.2 Message timeframe

The return to schedule message can be sent at any time and requires immediate return to schedule for a period defined in the contract.

9.4.3.3 Message description

The [Activation MarketDocument](#) is used as basis for this message.

Field Code Changed

Fields of the MarketDocument that are not described in this chapter cannot be used.

Activation_MarketDocument (exactly one element per message)		
Field	Mandatory	Description
mRID	Y	Unique identifier for the MarketDocument.
receiver_MarketParticipant.mRID	Y	The identification of the receiver (EIC code)
sender_MarketParticipant.mRID	Y	The role code associated with sender (EIC code). Must be 10X1001A1001A094 (Elia)
createdDateTime	Y	The timestamp on which the message was sent.
receiver_MarketParticipant.marketRole.type	Y	The role code associated with the receiver: Z02 = Scheduling Agent
sender_MarketParticipant.marketRole.type	Y	The role code associated with the sender: A04 = System Operator
revisionNumber	Y	Version number for the MarketDocument.
type	Y	Code for type of MarketDocument. Z03 = Schedule activation document
activation_Time_Period.timeInterval	Y	This information start and end date and time of the activation time interval. This period duration will equal 0. The time to respect the command is to be found in the contract.
TimeSeries	Y	This list has 1 or more elements

TimeSeries		
Field	Mandatory	Description
mRID	Y	Id of the return to schedule request
RegisteredResource	Y	List of registered resources associated with the TimeSeries
businessType	Y	Identifies the trading nature of the timeseries. Z09 = Return to schedule request
flowDirection.direction	Y	The coded identification of the direction of energy flow that is requested. If the delivery point's has margin to return to schedule in the same direction of the request, it has to return. If it is deviating from the schedule in the other direction it should not return. A01 = UP A02 = DOWN A03 = UP and DOWN
authorizedRange	Y	The return to schedule command will request either a return to the exact schedule or to a range between the schedule and the authorized boundary. Z01 = Schedule Z02 = Authorized Boundary
authorizedBoundary	N	Present in case Authorized Boundary is used. Depending on the energy flow of the Delivery point and the direction of the Return to schedule command, the following will determine the upper/lower boundary of the range starting from the schedule

timeInterval		
Field	Mandatory	Description
start	Y	The start date and time of the interval
end	Y	The end date and time of the interval

RegisteredResource		
Field	Mandatory	Description
mRID	Y	EAN code of a DeliveryPoint

9.4.4 Return to schedule acknowledged message

9.4.4.1 Message granularity

One return to schedule acknowledgement message must be sent for each return to schedule request sent by Elia.

9.4.4.2 Message timeframe

The acknowledgement message must be sent by the SA at the moment of the reception of the return to schedule request.

9.4.4.3 Message description

As described in the definition of acknowledgement message (see [Acknowledgement and answer messages](#)).

Field Code Changed

9.5 Submitting redispatching bids

9.5.1 Description

This information flow describes the process of submitting redispatching Energy Bids to Elia. If a Providing Group is mentioned in this section, the Redispatching Providing Group is meant.

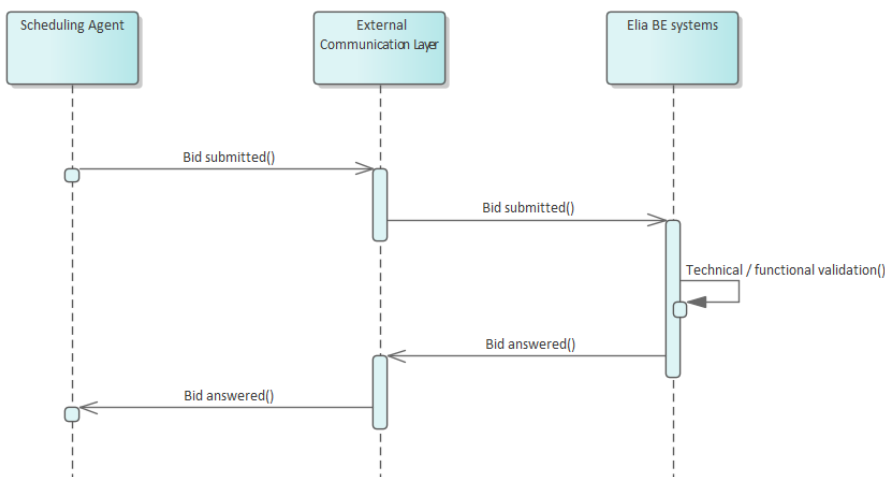

The Scheduling Agent will send a bid submitted message asynchronously to Elia. The External Communication Layer will treat the message in an asynchronous manner and will answer to it with the result of the validation done in the Elia backend systems.

9.5.2 Queue information

This table contains the queues and exchanges to send and receive messages in a normal scenario:

Message Type	Description	Sender	Receiver	Queue/Exchange
Redispatching Energy Bid Submitted	Submission of new bid or bid update	SA	Elia	RedispatchingEnergyBidSubmitted.In.Exch
Redispatching Energy Bid Answered	Answer to a bid message	Elia	SA	RedispatchingEnergyBidAnswered.[TargetMarketPartyID].OutQ

Error queues

This table contains the queues and exchanges to send and receive message only in case of error:

Message Type	Sender	Receiver	Queue/Exchange
Redispatching Energy Bid Submitted	Elia	SA	RedispatchingEnergyBidSubmitted.[TargetMarketPartyID].ErrorQ
Redispatching Energy Bid Answered	SA	Elia	RedispatchingEnergyBidAnswered.Error.Exch

9.5.3 Bid submitted message

9.5.3.1 Message granularity

For bidding, the granularity is set at the **Providing Group** and the **bid execution date** level. Meaning that for each combination of these objects, we expect exactly one single message per sent version.

9.5.3.2 Message timeframe

To allow the right context, the timeframe in which the redispatching bids are supposed to be submitted is described here. Note however that the exact timings are described in the contract of which the information always prevails.

- Redispatching bids must be sent before D-1 15h
- Redispatching bids can be updated until T - 45 min on execution date (Redispatching GCT)
- There is a standstill period between D-1 15h and D-1 18h. Redispatching bids received within this period will only be processed when the standstill period ends.



9.5.3.3 Message description

A [ReserveBid_MarketDocument](#) is the message that must be used in order to submit the redispatching Energy Bids.

Optional fields of the MarketDocument that are not described in this chapter cannot be used.

ReserveBid_MarketDocument (exactly one element per message)		
Field	Mandatory	Description
mRID	Y	Unique identification of the MarketDocument (UUID)
revisionNumber	Y	Version number for the market document
Type	Y	Type of market document. Fixed value: A24 = Bid Document
process.processType	Y	Code for type of process: A41 = Redispatch process

Field Code Changed

sender_MarketParticipant.mRID	Y	The identification of the sender (EIC code)
sender_MarketParticipant.marketRole.type	Y	The role code associated with the sender: Z02 = Scheduling Agent
receiver_MarketParticipant.mRID	Y	The identification of the receiver (EIC code). Fixed value: 10X1001A1001A094 = Elia
receiver_MarketParticipant.marketRole.type	Y	The role code associated with the receiver: A04 = System Operator
createdDateTime	Y	The date and time of the creation of the document
reserveBid_Period.timeInterval	Y	The beginning and ending date and time of the period covered by the document
Bid_TimeSeries	Y	Bid timeseries associated to the MarketDocument. It must contain at least one element.

Bid_TimeSeries		
Field	Mandatory	Description
mRID	Y	Unique identification of the bid timeseries within the MarketDocument
Status	N	Only used in case of cancellation, with the following code: A09 = Cancelled
businessType	Y	Identifies the trading nature of the timeseries: B74 = Offer
bidGroupId	Y	The unique identification used to identify associated bids with each other into a Bid Group. It is used to make sure all consecutive quarter hourly bids within this group will be technically linked to avoid unfeasible activations. The Bid Group Id will be used as activation reference together with the quarter hour concerned by the activation. This identification is defined by the sender and must be unique
multipartBidIdentification	N	The identification used to associate parent child bids. If the bid is not part of parent child group then the attribute is not used. This identification is defined by the sender and must be unique
exclusiveBidsIdentification	N	The identification used to associate exclusive bids. If bid is accepted then all others with same identification shall be ignored. If the bid is not exclusive then the attribute is not used. It allows multiple elements in this list.

		This identification is defined by the sender and must be unique
ProvidingGroup	Y	The delivery points that form the Redispatching Providing Group to which these bids are related. The list should contain at least one element.
BidGroup	N	The specific delivery points to which the Bid Group is related.
flowDirection.direction	Y	The coded identification of the direction of energy flow. A01 = UP A02 = DOWN
activation_ConstraintDuration.duration	N	Full-Activation Time (FAT) (in min) necessary to reach the offered maximum bid volume If no value is provided, a default value of 12,5 minutes will be used.
maximum_ConstraintDuration.duration	N	Maximum Activation time (MAT) (in min) during which the maximum bid volume can be activated If no value is provided, then there is no limitation on the maximum constraint duration.
minimum_ConstraintDuration.duration	N	Minimum Activation time (MIT) (in min) during which the bid needs to be activated If no value is provided, then there is no minimum activation time.
Linked_BidTimeSeries	N	List of conditionally linked bid timeseries.
Period	Y	List of periods associated to the timeseries. It should contain at least one element.

Period		
Field	Mandatory	Description
timeInterval	Y	The start and end date and time of the period
Resolution	Y	PT15M = 15 minutes
Point	Y	List of points associated to the period. It should contain as many points as needed to complete the period.

Point		
Field	Mandatory	Description
position	Y	The interval number defining which position in the timeseries is indicated. It must start at 1.
quantity.quantity	Y	The maximum Bid Volume offered in the bid
minimum_Quantity.quantity	N	The minimum volume that must be activated for this bid or Minimum bid volume (indivisible volume). If no value is provided, a default of 0 MW will be considered.
energy_Price.amount	Y	Bid Price in euro/MWh

maximum_EnergyLevel.energy	N	The Maximum Energy Level (MEL) indicates the maximum remaining energy for the Providing Group. If no value is provided, no limitation will be considered.
PointGroup	N	The specific delivery points to which the bid is related.
Reason	N	List of reasons associated to the point. Maximum one element.

Linked_BidTimeSeries		
Field	Mandatory	Description
mRID	Y	The bidGroupID to which the conditional link refers to
status	Y	The condition of the conditional linked bid: A55 = Not available if linked bid activated A56 = Not available if linked bid rejected A67 = Available if linked bid activated A68 = Available if linked bid rejected
level	Y	The level determines the position of the bid within the linked Bid Group with respect to the current bid: 1 = refers to t-1 of the linked bid with respect to the current position of this bid 2 = refers to t-2 of the linked bid with respect to the current position of this bid

RegisteredResource		
Field	Mandatory	Description
mRID	Y	EAN code of a DeliveryPoint

Reason		
Field	Mandatory	Description
code	Y	Y24 = Forced Outage The concerned Redispatching Energy Bid is impacted by a Forced Outage.

timeInterval		
Field	Mandatory	Description
Start	Y	The start date and time of the interval
End	Y	The end date and time of the interval

9.5.4 Validation of a bid submitted message

This information flow will be subject to all generic validation rules. These and the validation rules listed in the table below are further described in the following section of this document: [Validation rules description](#).

Field Code Changed

All threshold values used in the validation rules are subject to change and will be defined in the contract.

9.5.4.1 Validations on bid structure and time

ID	Validation Rule	Reply Status	Reason Code	Level
BID_001	The time period of the Energy Bid message must exactly cover one day	Reject message	Y86	MarketDocument
BID_002	All timeseries within the same message must have the same Redispatching Providing Group	Reject message	Y84	MarketDocument
BID_003	The bid timeseries period interval must be a multiple of 15 minutes	Reject message	A41	Timeseries
BID_004	No overlap of periods allowed for timeseries of the same Bid Group	Reject message	Y83	Timeseries
BID_005	The same MarketDocument mRID must be used per Providing Group, per MarketDocument time interval	Reject message	Y82	MarketDocument
BID_006	The Full-Activation Time (FAT) must be equal to 12,5 minutes or must be a multiple of 15 minutes	Reject message	Y81	Timeseries
BID_007	The Maximum Activation Time (MAT) must be a multiple of 15 minutes	Reject message	Y80	Timeseries
BID_008	A Delivery Point can only be part of one Redispatching Providing Group on one quarter hour on an execution date	Reject message	Y79	Timeseries
BID_065	It is not allowed to change the cancellation status for timeseries that have bids in the past	Reject message	Y14	Timeseries
BID_069	The Minimum Activation Time (MIT) must be a multiple of 15 minutes	Reject message	Y03	Timeseries
BID_070	Bids cannot have both a Minimum Activation Time (MIT) and a parent-child identification	Reject message	Y02	Timeseries
BID_071	Bids cannot have a Minimum Activation Time (MIT) that is greater than the Maximum Activation Time (MAT)	Reject message	Y01	Timeseries
BID_072	Bids with a Minimum Activation Time (MIT) can be used only if a condition A67 as conditional link is included	Reject message	X99	Timeseries
BID_073	Bids cannot have both a Minimum Activation Time (MIT) and a Full Activation Time (FAT) higher than default value	Reject message	X98	Timeseries
BID_080	The Maximum Energy Level for bids of the same providing group must be the same per direction and per quarter hour	Reject message	X92	Timeseries
BID_081	If a Maximum Energy Level is defined for a bid, then it must be defined for all bids from the Providing Group	Reject message	X91	Timeseries
BID_082	The Maximum Energy Level must be greater than or equal to zero	Reject message	X90	Timeseries
BID_083	Bids cannot have both a Maximum Energy Level and a Maximum Activation Time	Reject message	X89	Timeseries
BID_085	All bids from the same Bid Group must have the same direction	Reject message	X87	Timeseries

9.5.4.2 Validations on Delivery Point

ID	Validation Rule	Reply Status	Reason Code	Level
BID_009	The Delivery Points of the Bid Group must belong to the Redispatching Providing Group, if the Bid Group is defined	Reject message	Y78	Timeseries
BID_010	The Delivery Points in a specific quarter hour bid must belong to the Redispatching Providing Group	Reject message	Y77	Timeseries
BID_011	The sender market participant must have a valid contract right for each Delivery Point for the product on the execution date	Reject message	Y76	MarketDocument
BID_012	If a DP _{SU} Delivery Point is included in the Providing Group, then all other Delivery Points from that Providing Group must belong to the same Technical Facility	Reject message	Y75	MarketDocument
BID_059	The Delivery Points defined in a Point Group of a specific quarter hour bid must belong to the Bid Group, if the Bid Group is defined	Reject message	Y21	Timeseries

9.5.4.3 Validations on Bid Volume

ID	Validation Rule	Reply Status	Reason Code	Level
BID_015	The Minimum Bid Volume must be greater than or equal to zero and must be smaller than or equal to the Bid Volume	Reject message	Y74	Timeseries
BID_016	The Bid Volume be greater than or equal to zero	Reject message	Y73	Timeseries
BID_017	For bids submitted before Gate Closure Time the Bid Volume must be greater than or equal to 1 MW	Reject message	Y72	Timeseries
BID_018	Bid Volume granularity is equal to 1 MW	Reject message	Y71	Timeseries
BID_019	Minimum Bid Volume granularity is equal to 1 MW	Reject message	Y70	Timeseries
BID_022	The Bid Volume must be smaller than or equal to the sum of the values for technical maximum power	Reject message	Y69	Timeseries

9.5.4.4 Validations on Bid Price

ID	Validation Rule	Reply Status	Reason Code	Level
BID_026	Bid Price granularity is equal to 0,01 €/MWh	Reject message	Y68	Timeseries
BID_027	The Bid Price must be greater than or equal to a minimum threshold price and must be smaller than or equal to a maximum threshold price	Reject message	B51	Timeseries
BID_028	A warning will be given if the Bid Price is falls out of a threshold range determined by Elia	Accepted with warning	Y67	Timeseries

9.5.4.5 Validations on bid linking

ID	Validation Rule	Reply Status	Reason Code	Level
BID_029	Bids with the same parent-child identification must have the same Redispatching Providing Group	Reject message	Y66	Timeseries
BID_030	Bids with the same parent-child identification must have the same direction	Reject message	Y65	Timeseries
BID_032	Bids with the same parent-child identification must have different Bid Prices	Reject message	Y64	Timeseries
BID_033	Bids with a parent-child identification cannot have any conditionally linked bid timeseries	Reject message	Y63	Timeseries
BID_036	Bids cannot have both an exclusive bid identification and a parent-child identification	Reject message	Y62	Timeseries
BID_040	No technical linking is allowed across Redispatching Providing Groups	Reject message	Y41	Timeseries
BID_068	Bids cannot be conditionally available and conditionally unavailable at the same time	Reject message	Y04	Timeseries
BID_077	Conditionally linked bid timeseries must exist	Accepted with warning	X95	Timeseries
BID_078	Bids cannot be conditionally linked more than once to a given bid	Reject message	X94	Timeseries
BID_079	Bids cannot be cancelled if the Energy Bid is used in a conditional link	Reject message	X93	Timeseries
BID_086	It is not allowed to update the Bid Group Id of existing timeseries	Reject message	X85	Timeseries

9.5.4.6 Validations on timelines

ID	Validation Rule	Reply Status	Reason Code	Level
BID_042	No new Energy Bids can be submitted after Gate Closure Time	Reject message	Y47	Timeseries
BID_048	The execution date in the message must be greater than or equal to the current date and must be smaller than or equal to current date + 7 days	Reject message	Y60	MarketDocument
BID_044	If bids are updated after the Redispatching GCT it is only allowed to reduce the Bid Volume due to Forced Outage. All other properties must remain unchanged.	Reject message	Y59	Timeseries
BID_046	If bids are updated during the Redispatching GCT a reason needs to be provided	Reject message	Y58	Timeseries
BID_057	The Redispatching Energy Bid is received within the standstill period	Waiting for confirmation followed by accept or reject message	Y23	MarketDocument
BID_076	RD Energy Bids cannot be updated later than the start of the validity period of the bid	Reject message	Y22	Timeseries

9.5.5 Bid answered message

The bid answers are submitted by Elia and received by the SA.

Note: no acknowledgement of an answer is supported

9.5.5.1 Message granularity

One answer will be sent by Elia for each bid submitted message submitted by the SA.

9.5.5.2 Message timeframe

The confirmation message will be sent as soon as the bid message has been received and processed by Elia.

9.5.5.3 Message description

As described in the definition of answer message (see [Acknowledgement and answer messages](#)).

Field Code Changed

9.6 Receiving a redispatching activation request

9.6.1 Description

Elia will send asynchronous redispatching activation requests messages to the Scheduling Agent. If a Providing Group is mentioned in this section, the Redispatching Providing Group is meant.

Scheduling Agent will generate one acknowledgement and two confirmation messages:

- *Acknowledgement indicates the good reception of the activation request message*
- *First confirmation and second confirmation contain details about the activation performed following the activation request*

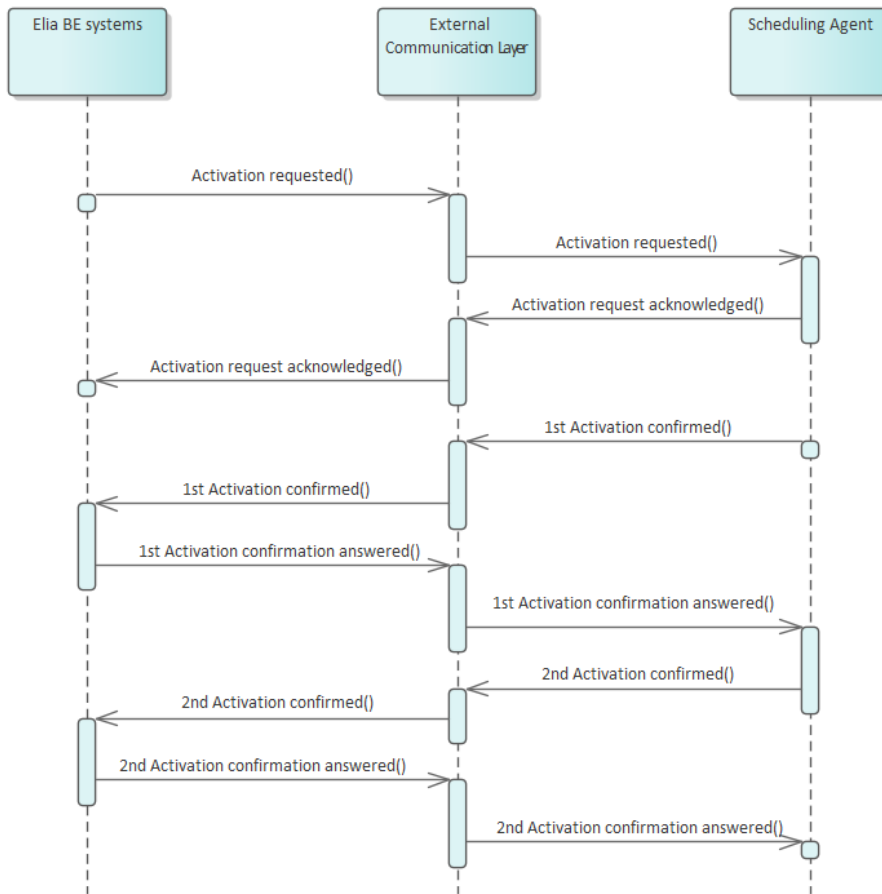

All communications in this flow are done asynchronously.

9.6.2 Queue information

This table contains the queues and exchanges to send and receive messages in a normal scenario:

Message Type	Description	Sender	Receiver	Queue/Exchange
Redispatching Activation Requested	Activation request	Elia	SA	RedispatchingActivationRequested.[TargetMarketPartyID].OutQ
	Activation request for cancellation purpose	Elia	SA	RedispatchingActivationCancelled.[TargetMarketPartyID].OutQ
Redispatching Activation Request Acknowledged	Reception confirmation of an activation	SA	Elia	RedispatchingActivationAcknowledged.In.Exch

	request message			
Redispatching Activation Confirmed	Confirmation of an activation request	SA	Elia	RedispatchingActivationConfirmed.In.Exch
Redispatching Activation Confirmation Answered	Answer to a confirmation of activation request message	Elia	SA	RedispatchingActivationConfirmationAnswered.[TargetMarketPartyID].OutQ

Error queues

This table contains the queues and exchanges to send and receive message only in case of error:

Message Type	Sender	Receiver	Queue/Exchange
Redispatching Activation Requested	SA	Elia	RedispatchingActivationRequested.Error.Exch
			RedispatchingActivationCancelled.Error.Exch
Redispatching Activation Request Acknowledged	Elia	SA	RedispatchingActivationAcknowledged.[TargetMarketPartyID].ErrorQ
Redispatching Activation Confirmed	Elia	SA	RedispatchingActivationConfirmed.[TargetMarketPartyID].ErrorQ
Redispatching Activation Confirmation Answered	SA	Elia	RedispatchingActivationConfirmationAnswered.Error.Exch

9.6.3 Activation requested message

9.6.3.1 Message granularity

A redispatching activation request message groups all selected redispatching Energy Bids from a respective Scheduling Agent covering 1 or multiple quarter hours.

A redispatching activation request for cancellation purpose can contain the cancellation for several redispatching activation requests previously sent by Elia.

9.6.3.2 Message timeframe

The redispatching activation request message can be sent at any time but will respect the FAT and will indicate whether it is a Redispatching Scheduled Activation or a Redispatching Direct Activation.

For a Scheduled Activation request, the start and end time communicated in the activation request message will be the beginning of the first quarter hour of activation and end of the last quarter hour of activation.

For a Direct Activation request:

- If FAT of respective redispatching energy bid = 12,5 minutes, the start and end time communicated in the activation request message will be 7,5 minutes after the reception of the activation request and end of the last quarter hour of activation.

- If FAT of respective redispatching energy bid > 12,5 minutes, the start and end time communicated in the activation request message will be [FAT – 7.5min] after the reception of the activation and end of the last quarter hour of activation.

9.6.3.3 Message description

An [Activation MarketDocument](#) is the message that is used to request a redispatching activation.

Field Code Changed

Activation_MarketDocument (Exactly one element per message)		
Field	Mandatory	Description
mRID	Y	Unique identifier for the MarketDocument
revisionNumber	Y	Version number for the MarketDocument.
Type	Y	Code for type of MarketDocument. A96 = Redispatch Activation Document Z06 = Cancellation
process.processType	Y	Code for type of process. A60 = "Scheduled activation" A61 = "Direct activation"
sender_MarketParticipant.mRID	Y	The identification of the sender (EIC code) 10X1001A1001A094 = Elia
sender_MarketParticipant.marketRole.type	Y	The role code associated with receiver. Fixed value: A04 = System Operator
receiver_MarketParticipant.mRID	Y	The identification of the receiver (EIC code)
receiver_MarketParticipant.marketRole.type	Y	The role code associated with the receiver: Z02 = Scheduling Agent
createdDateTime	Y	The timestamp on which the message was sent
activation_Time_Period.timeInterval	Y	This information provides the start and end date and time of the activation time interval
TimeSeries	Y	Timeseries associated to the market document. It must contain at least one element.

TimeSeries		
Field	Mandatory	Description
mRID	Y	Bid Group Id of the activated redispatching bid.
businessType	Y	Identifies the reason why an activation is requested. Z04 = National congestion management Z05 = XB congestion management Z06 = Exhausted reserves/escalation procedure Z10 = Balancing (FCRE exceptional measures)
measurement_Unit.name	Y	MAW (Megawatt)
flowDirection.direction	Y	The coded identification of the direction of energy flow. A01 = UP A02 = DOWN
Period	Y	This list can only contain 1 element

Period		
Field	Mandatory	Description

timeInterval	Y	The start and end date and time of the redispatching activation.
Resolution	Y	Amount of time for each interval in which a data value is defined. Fixed value: PT15M = 15 minutes
Point	Y	List of points associated to the period. It should contain as many point as needed to complete the period.

Point		
Field	Mandatory	Description
position	Y	The interval number defining which position in the timeseries is indicated. It must start at 1.
Quantity	Y	Power requested. The principal quantity identified for a point. We require an accuracy of 1 MW.

timeInterval		
Field	Mandatory	Description
start	Y	The start date and time of the interval
end	Y	The end date and time of the interval

Note! An Activation_MarketDocument with a type “Cancellation” can contain cancellations for multiple redispatching activation requests. It can contain multiple Bid Groups that are cancelled.

This means that the mRID of the MarketDocument used for cancellation is different to the mRID of the original redispatching activations and revisionNumber will have a value of 1.

9.6.4 Activation acknowledged message

9.6.4.1 Message granularity

One redispatching activation acknowledgement must be sent for each redispatching activation request submitted by Elia.

9.6.4.2 Message timeframe

This acknowledgement must be sent immediately after the reception of the redispatching activation request message.

9.6.4.3 Message description

As described in the definition of acknowledgement message (see [Acknowledgement and answer messages](#)).

Field Code Changed

9.6.5 Activation confirmed message

For a redispatching activation, the Scheduling Agent must confirm the activation request by sending Elia two confirmation messages.

The confirmation messages must be sent after the acknowledgement message.

A confirmation message includes the list of delivery points that will be used to deliver the requested energy as well as the expected contribution per delivery point.

9.6.5.1 Message granularity

A confirmation message is sent for each activation request received. Multiple confirmations cannot be grouped in a same message.

9.6.5.2 Message timeframe

1st activation confirmation message is sent by the Scheduling Agent for the entire activation at once, at latest 5 minutes after the reception of the activation request.

2nd activation confirmation is sent by the Scheduling Agent for the entire activation at once, at latest 8 minutes after the end of the last quarter hour of the activation.

9.6.5.3 Message description

A document [ActivationConfirmation_MarketDocument](#) is used for this message.

Optional fields of the market document that are not described in this chapter cannot be used.

ActivationConfirmation_MarketDocument (Exactly one element per message)		
Field	Mandatory	Description
mRID	Y	Unique identifier for the market document
revisionNumber	Y	Version number for the MarketDocument
type	Y	Code for type of market document. Z07 = 1 st confirmation Z08 = 2 nd confirmation
sender_MarketParticipant.mRID	Y	The identification number of the sender (EIC code).
Sender_MarketParticipant.marketRole.type	Y	The role code associated with the sender Z02 = Scheduling Agent
receiver_MarketParticipant.mRID	Y	The identification of the receiver (EIC code). 10X1001A1001A094 = Elia
receiver_MarketParticipant.marketRole.type	Y	The role code associated with the receiver A04 = System operator
createdDateTime	Y	The timestamp on which the message was sent
confirmed_MarketDocument.mRID	Y	The market document identification to which is replied
confirmed_MarketDocument.revisionNumber	Y	The market document revision number to which is replied
activation_Time_Period.timeInterval	Y	The start and end date and time of the activation to which all confirmed timeseries refers to
Confirmed_TimeSeries	Y	The timeseries replied to

Confirmed_TimeSeries		
Field	Mandatory	Description
mRID	Y	Bid Group Id
Period	Y	Periods associated to the timeseries.

		This list can only contain 1 element
--	--	--------------------------------------

Period		
Field	Mandatory	Description
timeInterval	Y	The start and end date and time of the activation for the timeseries
resolution	Y	PT15M = 15 minutes
Point	Y	List of points associated to the period. It should contain as many points as needed to complete the period.

Point		
Field	Mandatory	Description
position	Y	The interval number defining which position in the timeseries is indicated
quantity	Y	The principal quantity identified for a point. We require an accuracy of 1 MW.
RegisteredResource	Y	List of registered resources associated to this point. It contains the delivery points used for the activation, with their contribution

RegisteredResource		
Field	Mandatory	Description
mRID	Y	EAN code of a delivery point
quantity	Y	Expected contribution per delivery point. The principal quantity identified for a point. We require an accuracy of 0.1 MW.

timeInterval		
Field	Mandatory	Description
start	Y	Start time of the interval
end	Y	End time of the interval

9.6.6 Validation of an activation confirmed message

This information flow will be subject to all generic validation rules. These and the validation rules listed in the table below are further described in the following section of this document: [Validation rules description](#).

Field Code Changed

ID	Validation Rule	Reply Status	Reason Code	Level
ACT_001	Confirmation deadline not respected	Accept with warning	A57	MarketDocument
ACT_002	TimeSeries not matching	Accept with warning	A09	MarketDocument
ACT_003	Resolution inconsistency	Accept with warning	A41	Timeseries

ACT_004	Quantity inconsistency	Accept with warning	A42	MarketDocument
ACT_005	Quantity increased	Accept with warning	A43	MarketDocument
ACT_006	Quantity decreased	Accept with warning	A44	MarketDocument
ACT_007	Resource Object invalid	Accept with warning	A64	Timeseries

The first valid 1st Activation Confirmed message and 2nd Activation Confirmed message will be kept as truth by the systems. This means that if two 1st Activation Confirmed message are sent by the BSP (one via the ECL and one via the back-up via e-mail for example), only the first document received will be accepted by the systems and the following one will be rejected.

9.6.7 Activation confirmation answered message

9.6.7.1 Message granularity

An activation confirmation answered message is sent for each activation confirmed message received. Multiple validations cannot be grouped in a same message.

9.6.7.2 Message timeframe

An activation confirmation answered message is sent as soon as the activation confirmed message is processed by Elia.

9.6.7.3 Message description

As described in the definition of answer message (see [Acknowledgement and answer messages](#)).

Field Code Changed

9.6.8 Back-up activation request message

As mentioned in chapter 3.3, a back-up communication channel is put in place for the sending of activation request messages.

If Elia does not receive an activation acknowledged message within a reasonable timeframe after the sending of the activation requested message, Elia will automatically trigger the back-up process.

9.6.8.1 Activation requested message

The Redispatching activation requested message will be sent via e-mail to the contractual 24/7 email address provided by the SA.

Title of the message: Elia – Activation Request – RD – Start Date and Time – End Date and Time

Example: Elia – Activation Request – RD – 05/10/2023 12:45 – 05/10/2023 17:00

Body of the message:

Hello – ELIA has not received a technical acknowledgement after an activation was requested.

This message serves as a back-up communication for the below redispatching activation:

BidGroupld	Start time	DP

Bid group ID of the activated Bid	Requested volume in MW	List of DP EAN included in the Energy bid
-----------------------------------	------------------------	---

Example:

<i>BidGroupId</i>	<i>12:45</i>	<i>DP</i>
<i>MAT-3 Test_RD00_Up</i>	<i>25,0</i>	<i>541453137445795650;541453127036684861</i>

Attachement:

The RD activation requested message described in Chapter 9.6.3 initially sent to the SA (JSON) will be included as attachement to the email.

9.6.8.2 Activation acknowledged message

Activation acknowledged message will be accepted via e-mail but are not compulsory for the good execution of the process. Such message has to be sent to activation@elia.be (ActivationDEMO@Elia.be for the DEMO environment).

Field Code Changed

Field Code Changed

The validation rules applied to the Activation acknowledged message will be similarly applied to the Activation acknowledged message sent via email.

Title of the message: SA Name – Activation acknowledged message – RD– Start Date and Time – End Date and Time

Example: SA1- Activation acknowledged message – RD – 05/10/2023 12:45 – 05/10/2023 13:00

Body of the message:

Nothing is expected in the body of the message. Any content added In the body of the message will be accepted but disregarded by Elia.

Attachement:

The Activation acknowledged message described in Chapter 9.6.4 that should have been sent via ECL by the SA(JSON) has to be included as attachement to the email.

9.6.8.3 Activation confirmed message

The two Activation confirmed messages have to be sent via e-mail (two different e-mails are expected, one for the first and one for the second activation confirmed messages) and are mandatory for the good execution of the process. Such messages have to be sent to activation@elia.be (ActivationDEMO@Elia.be for the DEMO environment).

Field Code Changed

Title of the message:

First activation confirmed message: SA Name – FirstBusinessAck – RD – Start Date and Time – End Date and Time

Second activation confirmed message : SA Name – SecondBusinessAck – RD – Start Date and Time – End Date and Time

Example: SA1 – FirstBusinessAck – RD – 05/10/2023 12:45 – 05/10/2023 13:00

Body of the message:

Nothing is expected in the body of the message. Any content added In the body of the message will be disregarded by Elia.

Attachement:

The two Activation confirmed messages described in Chapter 9.6.5 [10.6.4](#) that should have been sent via ECL by the BSP (JSON) have to be included respectively as attachment to each email.

9.6.8.4 Validation of an activation confirmed message

The validation rules described in chapter 9.6.6 applied to the Activation confirmed messages will be similarly applied to the Activation confirmed messages sent via email.

9.6.8.5 Activation confirmation answered message

Each of the Activation confirmed message will receive an answer from Elia.

Title of the message:

First activation confirmed message : Elia – AckOnFirstBusinessAck – SA- Start Date and Time – End Date and Time

Second activation confirmed message : Elia – AckOnSecondBusinessAck – SA– Start Date and Time – End Date and Time

Body of the message:

Hello – we did receive a BusinessAck1 or BusinessAck2 by email, therefore, Elia send back the ack by mail:

confirmed_MarketDocument.mRID	code	Text
309d975a8b4d4a6981e85b36fbbba1a00	A01	Message fully accepted

Attachement:

The RD activation confirmation answered message described in Chapter [9.6.7](#) that should have been sent to the SA (JSON) will be included as attachment to the email.

Deleted: 9.6.7

9.7 Receiving a Market Party notification

9.7.1 Description

This message exchange is described in the following section: [Notification messages](#).

Field Code Changed

9.7.2 Queue information

A notification message can arrive into two different queues, specific to each domain (one for scheduling and one for bidding). The acknowledgement message must be sent to the queue corresponding to the same domain as the received request.

The following tables contain the queues and exchanges to send and receive messages in a normal scenario:

Message Type	Description	Sender	Receiver	Queue/Exchange
Scheduling Agent Notification Submitted	Submission of a Market Party notification	Elia	SA	SchedulingAgentNotificationSubmitted.[TargetMarketPartyID].OutQ
Scheduling Agent Notification Acknowledged	Reception confirmation of a Market Party notification	SA	Elia	SchedulingAgentNotificationAcknowledged.in.Exch

Error queues

The following tables contain the queues and exchanges to send and receive message only in case of error:

Message Type	Sender	Receiver	Queue/Exchange
Scheduling Agent Notification Submitted	SA	Elia	SchedulingAgentNotificationSubmitted.Error.Exch
Scheduling Agent Notification Acknowledged	Elia	SA	SchedulingAgentNotificationAcknowledged.[TargetMarketPartyID].ErrorQ

9.8 Receiving a redispatching communication test

9.8.1 Description

The goal of the test is to test the communication between Elia and Scheduling Agent. Therefore the communication test will go through the same communication layers as an activation.

A communication test has an activation message with a specific BidGroupID: "CommunicationTest" and a specific DP ean: "99999999999999999999".

After reception of the activation message in the communication test, the Scheduling Agent generates one acknowledgement and two confirmation messages:

- Acknowledgement indicates the good reception of the communication test request message
- First confirmation and second confirmation contain details about the communication test performed following the activation request

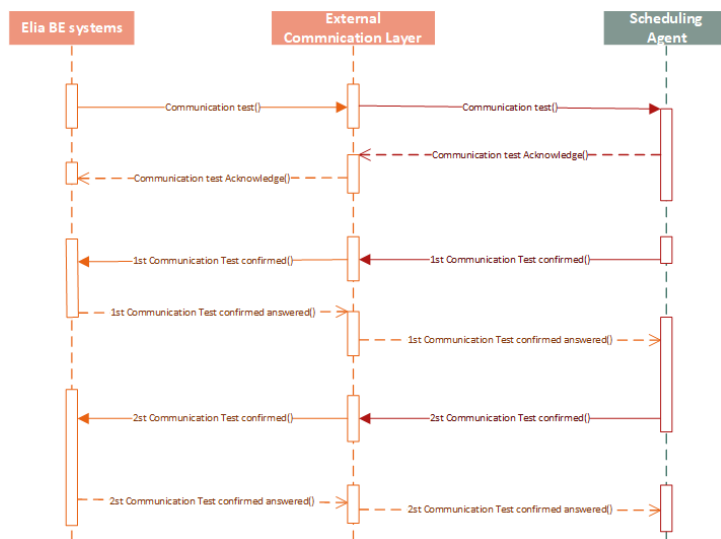

All communications in this flow are done asynchronously.

9.8.2 Queue information

This table contains the queues and exchanges to send and receive messages in a normal scenario:

Message Type	Description	Sender	Receiver	Queue/Exchange
Redispatching Activation Requested	Activation request	Elia	SA	RedispatchingActivationRequested.[TargetMarketPartyID].OutQ
	Activation request for cancellation purpose	Elia	SA	RedispatchingActivationCancelled.[TargetMarketPartyID].OutQ
Redispatching Activation Request Acknowledged	Reception confirmation of an activation request message	SA	Elia	RedispatchingActivationAcknowledged.In.Exch
Redispatching Activation Confirmed	Confirmation of an activation request	SA	Elia	RedispatchingActivationConfirmed.In.Exch
Redispatching	Answer to a confirmation	Elia	SA	RedispatchingActivationConfirmationAnswered.[TargetMarketPartyID].OutQ

Activation Confirmation Answered	of activation request message			
---	-------------------------------	--	--	--

Error queues

This table contains the queues and exchanges to send and receive message only in case of error:

Message Type	Sender	Receiver	Queue/Exchange
Redispatching Activation Requested	SA	Elia	RedispatchingActivationRequested.Error.Exch
			RedispatchingActivationCancelled.Error.Exch
Redispatching Activation Request Acknowledged	Elia	SA	RedispatchingActivationAcknowledged.[TargetMarketPartyID].ErrorQ
Redispatching Activation Confirmed	Elia	SA	RedispatchingActivationConfirmed.[TargetMarketPartyID].ErrorQ
Redispatching Activation Confirmation Answered	SA	Elia	RedispatchingActivationConfirmationAnswered.Error.Exch

9.8.3 Activation requested message

9.8.3.1 Message granularity

Similar as a redispatching activation request message, a redispatching communication test message groups all selected redispatching Energy Bids from a respective Scheduling Agent covering 1 or multiple quarter hours.

A redispatching communication test request for cancellation purpose can contain the cancellation for several redispatching communication test requests previously sent by Elia.

9.8.3.2 Message timeframe

The redispatching communication test message can be sent at any time and indicates whether it is a redispatching Scheduled Activation or a redispatching Direct Activation.

For a Scheduled Activation request, the start time communicated in the activation request message is the beginning of the first quarter hour of activation and the end time is the end of the last quarter hour of activation.

For a Direct Activation request, the start time communicated in the activation request message is the beginning of the earliest possible time where we can send the communication test and the end time is the end of the last quarter hour of activation.

9.8.3.3 Message description

An `Activation_MarketDocument` is the message used to request a Redispatching communication test.

Activation_MarketDocument (Exactly one element per message)

Field Code Changed

Field Code Changed

Field	Mandatory	Description
mRID	Y	Unique identifier of the MarketDocument
revisionNumber	Y	Version number for the MarketDocument.
Type	Y	Code for type of MarketDocument. A96 = Redispatch Activation Document Z06 = Cancellation
process.processType	Y	Code for type of process. A60 = "Scheduled activation" A61 = "Direct activation"
sender_MarketParticipant.mRID	Y	The identification of the sender (EIC code) 10X1001A1001A094 = Elia
sender_MarketParticipant.marketRole.type	Y	The role code associated with receiver. Fixed value: A04 = System Operator
receiver_MarketParticipant.mRID	Y	The identification of the receiver (EIC code)
receiver_MarketParticipant.marketRole.type	Y	The role code associated with the receiver: Z02 = Scheduling Agent
createdDateTime	Y	The timestamp on which the message was sent
activation_Time_Period.timeInterval	Y	This information provides the start and end date and time of the activation time interval
TimeSeries	Y	Timeseries associated to the market document. It must contain at least one element.

TimeSeries		
Field	Mandatory	Description
mRID	Y	Bid Group Id of the activated redispatching bid. CommunicationTest = Communication Test mRID
businessType	Y	Identifies the reason why an activation is requested. Z04 = National congestion management Z05 = XB congestion management Z06 = Exhausted reserves/escalation procedure Z10 = Balancing (FCRE exceptional measures)
measurement_Unit.name	Y	MAW (Megawatt)
flowDirection.direction	Y	The coded identification of the direction of energy flow. A01 = UP A02 = DOWN
Period	Y	This list can only contain 1 element

Period		
Field	Mandatory	Description
timeInterval	Y	The start and end date and time of the redispatching activation.
Resolution	Y	Amount of time for each interval in which a data value is defined. Fixed value: PT15M = 15 minutes
Point	Y	List of points associated to the period. It should contain as many point as needed to complete the period.

Point		
Field	Mandatory	Description
position	Y	The interval number defining which position in the timeseries is indicated. It must start at 1.
Quantity	Y	Power requested. The principal quantity identified for a point. We require an accuracy of 1 MW.

timeInterval		
Field	Mandatory	Description
start	Y	The start date and time of the interval
end	Y	The end date and time of the interval

Note! An Activation_MarketDocument with a type “Cancellation” can contain cancellations for multiple redispatching activation requests. It can contain multiple Bid Groups that are cancelled.

This means that the mRID of the MarketDocument used for cancellation is different to the mRID of the original Redispatching activations and revisionNumber will have a value of 1.

9.8.4 Activation acknowledged message

9.8.4.1 Message granularity

One redispatching communication test acknowledgement must be sent for each redispatching communication test request submitted by Elia.

9.8.4.2 Message timeframe

This acknowledgement must be sent immediately after the reception of the redispatching communication test request message.

9.8.4.3 Message description

As described in the definition of acknowledgement message (see [Acknowledgement and answer messages](#)).

Field Code Changed

Field Code Changed

9.8.5 Activation confirmed message

For a redispatching communication test, the Scheduling Agent must confirm the activation request by sending Elia two confirmation messages.

The confirmation messages must be sent after the acknowledgement message.

A confirmation message includes the list of delivery points that will be used to deliver the requested energy as well as the expected contribution per delivery point. The delivery points used for the Communication Test will by default: “999999999999999999”.

9.8.5.1 Message granularity

A confirmation message is sent for each communication request received. Multiple confirmations cannot be grouped in a same message.

9.8.5.2 Message timeframe

1st communication test confirmation message is sent by the Scheduling Agent for the entire communication test at once, at latest 5 minutes after the reception of the communication test request.

2nd communication test confirmation is sent by the Scheduling Agent for the entire communication test at once, at latest 8 minutes after the end of the last quarter hour of the communication test.

9.8.5.3 Message description

A document ActivationConfirmation_MarketDocument is used for this message.

Optional fields of the market document that are not described in this chapter cannot be used.

ActivationConfirmation_MarketDocument (Exactly one element per message)		
Field	Mandatory	Description
mRID	Y	Unique identifier of the market document
revisionNumber	Y	Version number for the MarketDocument
type	Y	Code for type of market document. Z07 = 1 st confirmation Z08 = 2 nd confirmation
sender_MarketParticipant.mRID	Y	The identification number of the sender (EIC code).
Sender_MarketParticipant.marketRole.type	Y	The role code associated with the sender Z02 = Scheduling Agent
receiver_MarketParticipant.mRID	Y	The identification of the receiver (EIC code). 10X1001A1001A094 = Elia
receiver_MarketParticipant.marketRole.type	Y	The role code associated with the receiver A04 = System operator
createdDateTime	Y	The timestamp on which the message was sent
confirmed_MarketDocument.mRID	Y	The market document identification to which is replied
confirmed_MarketDocument.revisionNumber	Y	The market document revision number to which is replied
activation_Time_Period.timeInterval	Y	The start and end date and time of the activation to which all confirmed timeseries refers to
Confirmed_TimeSeries	Y	The timeseries replied to

Confirmed_TimeSeries		
Field	Mandatory	Description
mRID	Y	Bid Group Id CommunicationTest = Communication Test mRID
Period	Y	Periods associated to the timeseries. This list can only contain 1 element

ACT_005	Quantity increased	Accept with warning	A43	MarketDocument
ACT_006	Quantity decreased	Accept with warning	A44	MarketDocument
ACT_007	Resource Object invalid	Accept with warning	A64	Timeseries

9.8.7 Communication test confirmation answered message

9.8.7.1 Message granularity

A communication test confirmation answered message is sent for each communication test confirmed message received. Multiple validations cannot be grouped in a same message.

9.8.7.2 Message timeframe

A communication test confirmation answered message is sent as soon as the communication test confirmed message is processed by Elia.

9.8.7.3 Message description

As described in the definition of answer message (see [Acknowledgement and answer messages](#)).

Field Code Changed

Field Code Changed

9.9 Receiving a Market Party notification

9.9.1 Description

This message exchange is described in the following section: [Notification messages](#).

Field Code Changed

Field Code Changed

9.9.2 Queue information

A notification message can arrive into two different queues, specific to each domain (one for scheduling and one for bidding). The acknowledgement message must be sent to the queue corresponding to the same domain as the received request.

The following tables contain the queues and exchanges to send and receive messages in a normal scenario:

Message Type	Description	Sender	Receiver	Queue/Exchange
Scheduling Agent Notification Submitted	Submission of a Market Party notification	Elia	SA	SchedulingAgentNotificationSubmitted.[TargetMarketPartyID].OutQ
Scheduling Agent Notification Acknowledged	Reception confirmation of a Market Party notification	SA	Elia	SchedulingAgentNotificationAcknowledged.In.Exch

Error queues

The following tables contain the queues and exchanges to send and receive message only in case of error:

Message Type	Sender	Receiver	Queue/Exchange
Scheduling Agent Notification Submitted	SA	Elia	SchedulingAgentNotificationSubmitted.Error.Exch
Scheduling Agent Notification Acknowledged	Elia	SA	SchedulingAgentNotificationAcknowledged.[TargetMarketPartyID].ErrorQ

9.10 Retrieving Schedules

9.10.1 Description

This message exchange allows the Scheduling Agent to retrieve previously submitted Schedules via the External Communication Layer. Elia will only return the latest accepted Market Documents at the time of the query following the request.

This information flow describes the process of requesting schedule details via the External Communication Layer.

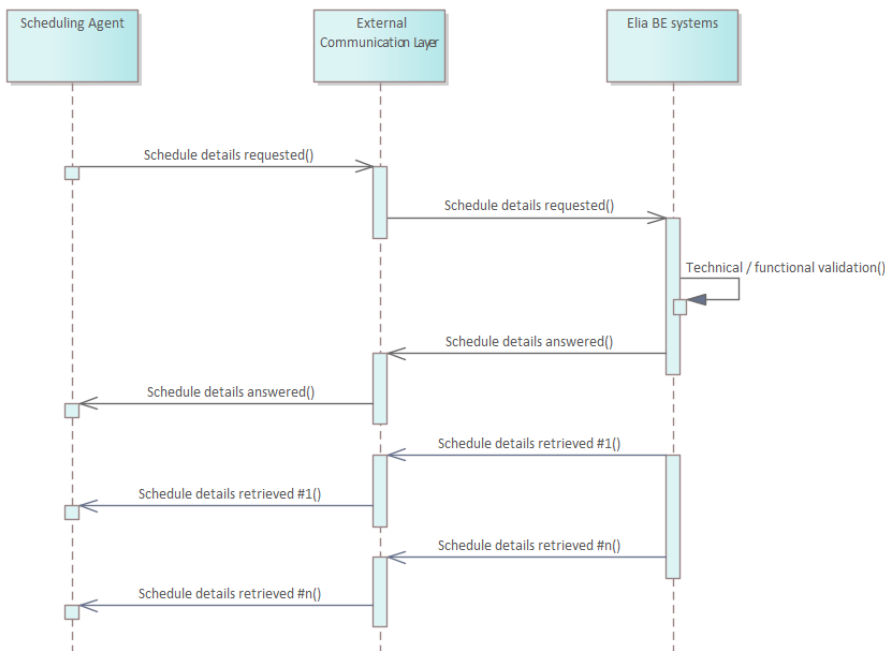

9.10.2 Queue information

This table contains the queues and exchanges to send and receive messages in a normal scenario. The Schedule Details Answered queue will be used to indicate whether the request was valid and whether

or not results were found. If the request was valid and results were found, they will be published on the Schedule Retrieved queue.

Message Type	Description	Sender	Receiver	Queue/Exchange
Schedule Details Requested	Requesting Schedules to be retrieved	SA	Elia	ScheduleDetailsRequested.In.Exch
Schedule Details Retrieved	The result of the requested Schedules	Elia	SA	ScheduleDetailsRetrieved.[TargetMarketPartyID].OutQ
Schedule Details Answered	The answer to the request message	Elia	SA	ScheduleDetailsAnswered.[TargetMarketPartyID].OutQ

Error queues

This table contains the queues and exchanges to send and receive messages only in case of error.

Message Type	Sender	Receiver	Queue/Exchange
Schedule Details Requested	Elia	SA	ScheduleDetailsRequested.[TargetMarketPartyID].ErrorQ
Schedule Details Retrieved	SA	Elia	ScheduleDetailsRetrieved.Error.Exch
Schedule Details Answered	SA	Elia	ScheduleDetailsAnswered.Error.Exch

9.10.3 Schedule details requested message

9.10.3.1 Message granularity

Requesting Schedules will be limited to one execution day and can be filtered using input parameters. If these are not used, all relevant Market Documents for the requested period will be returned. In the retrieval, Elia will send back each Market Document in a separate message.

9.10.3.2 Message timeframe

Requests will be limited in frequency and period for performance reasons as described in the validation rules.

9.10.3.3 Message description

A document [Request MarketDocument](#) is used for the Schedule Request.

Field Code Changed

Request_MarketDocument (exactly one element per message)		
Field	Mandatory	Description
mRID	Y	Unique identification of the Request Market Document
type	Y	Type of market document. Z13 = Schedule Request
process.processType	Y	Code for type of process: A17 = Schedule day
sender_MarketParticipant.mRID	Y	The identification of the sender (EIC code)
sender_MarketParticipant.marketRole.type	Y	The role code associated with the sender:

		Z02 = Scheduling Agent
receiver_MarketParticipant.mRID	Y	The identification number of the Receiver(EIC code). Fixed value: 10X1001A1001A094 = Elia
receiver_MarketParticipant.marketRole.type	Y	The role code associated with sender. Fixed value: A04 = System Operator
createdDateTime	Y	The date and time of the creation of the Request Market Document
request_Period.timeInterval	Y	The beginning and ending date and time of the period covered by the document. This cannot exceed an execution day.
Request_TimeSeries	Y	Request_TimeSeries contained in the message

Request_TimeSeries		
Field	Mandatory	Description
mRID	Y	Unique identification of the Request_TimeSeries within the market document
requested_MarketDocument.mRID	N	The Market Document mRID can be set here if a specific Market Document is requested. If not used, this filter is not applied.
Requested_RegisteredResource.mRID	N	The delivery point EAN representing the point for which the schedule is sent. If not used, this filter is not applied.

timeInterval		
Field	Mandatory	Description
start	Y	The start date and time of the interval
end	Y	The end date and time of the interval

RegisteredResource		
Field	Mandatory	Description
mRID	Y	EAN code of a DeliveryPoint

9.10.4 Validation of a schedule details requested message

This information flow will be subject to all generic validation rules. These and the validation rules listed in the table below are further described in the following section of this document: [Validation rules description](#).

Request messages that are rejected will be answered with the Answer message as described in the definition of answer message (see [Acknowledgement and answer messages](#)). When the request is valid, the Schedule Retrieval message described in the next section will be returned.

9.10.4.1 Validations on request process

ID	Validation Rule	Reply Status	Reason Code	Level
REQ_001	The request did not generate any results	Accepted with warnings	Y11	MarketDocument

Field Code Changed

Field Code Changed

REQ_002	The number of requests per 15 minutes cannot exceed the threshold limit	Reject message	Y10	MarketDocument
REQ_003	The request can cover maximum one execution day	Reject message	Y09	MarketDocument

9.10.5 Schedule details retrieved message

9.10.5.1 Message granularity

For scheduling, the granularity is set at the Delivery Point and the bid execution date level. Meaning that for each combination of these objects, we will send exactly one single message. So if the request requires multiple Delivery Points, these will be split per message, similarly to the schedule submission. In the retrieved message we will only send back the last accepted version of a Market Document.

9.10.5.2 Message timeframe

The message(s) will be returned as soon as possible after a valid request was made.

9.10.5.3 Message description

Schedule_MarketDocument (Exactly one element per message)		
Field	Mandatory	Value(s)
mRID	Y	Unique identification of the market document (UUID)
revisionNumber	Y	Version number for the market document
type	Y	Type of market document. Fixed value: Z02 = Active Power Schedule Document
process.processType	Y	Code for type of process: A17 = Schedule day
process.classificationType	Y	Defines whether the schedule is an aggregation or a classification. Fixed value: A01 = detail type
sender_MarketParticipant.mRID	Y	The identification of the receiver (EIC code). Fixed value: 10X1001A1001A094 = Elia
sender_MarketParticipant.marketRole.type	Y	The role code associated with receiver. Fixed value: A04 = System Operator
receiver_MarketParticipant.mRID	Y	The identification of the sender (EIC code)
receiver_MarketParticipant.marketRole.type	Y	The role code associated with sender: Z02 = Scheduling Agent
createdDateTime	Y	The date and time of the reception of the Market Document by Elia
schedule_Time_Period.timeInterval	Y	The start and end date and time of the day to which the schedule refers to (execution date)
domain.mRID	Y	10YBE-----2 = Belgian bidding zone
TimeSeries	Y	This list only allows 1 element

TimeSeries		
Field	Mandatory	Value(s)
mRID	Y	Sender's identification of the timeseries.
Version	Y	Fixed value:

		1
businessType	Y	Identifies the trading nature of the timeseries: Z12 = Net Consumption – Production
product	Y	The energy product of the schedule timeseries. Fixed value: 8716867000016 = active power
objectAggregation	Y	Identifies how the object is aggregated. Fixed value: Z01 = Delivery Point
registeredResource.mRID	Y	The delivery point EAN representing the point for which the schedule is sent
measurement_Unit.name	Y	MAW = expressed scheduled power is in Megawatt
Period	Y	This list only allows 1 element

Period		
Field	Mandatory	Value(s)
timeInterval	Y	The start and end date and time to which the schedule timeseries refer to
resolution	Y	Amount of time for each interval in which a data value is defined. Fixed value: PT15M = 15 minutes
Point	Y	List of points associated to the period. It should contain as many point as needed to complete the period.

Point		
Field	Mandatory	Value(s)
position	Y	The interval number defining which position in the timeseries is indicated. It must start at 1.
Quantity	Y	The list of schedule intervals in which the value (MW) of the scheduled power is given. We require an accuracy of 0.1 MW.
Reason	N	This list that can only contain one element. Only used in case of a schedule update because of forced outage.

timeInterval		
Field	Mandatory	Value(s)
start	Y	The start date and time of the interval
end	Y	The end date and time of the interval

Reason		
Field	Mandatory	Value(s)
code	Y	Y24 = Forced Outage

9.10.6 Schedule details answered message

The bid answered message for Schedule details requested is identical to the Schedule answered message.

As described in the definition of answer message (see [Acknowledgement and answer messages](#)).

Field Code Changed

9.11 Retrieving Energy Bids

9.11.1 Description

This message exchange allows the Scheduling Agent to retrieve previously submitted Redispatching Energy Bids via the External Communication Layer. Elia will only return the latest accepted Market Documents at the time of the query following the request.

This information flow describes the process of requesting bid details via the External Communication Layer.

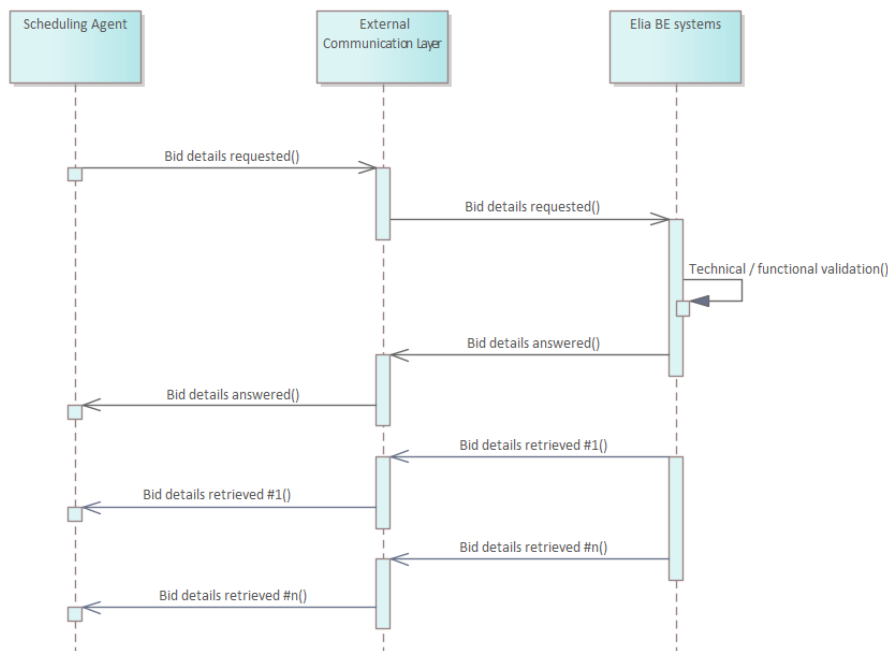

9.11.2 Queue information

This table contains the queues and exchanges to send and receive messages in a normal scenario. The Bid Details Answered queue will be used to indicate whether the request was valid and whether or not results were found. If the request was valid and results were found, they will be published on the Bid Details Retrieved queue.

Message Type	Description	Sender	Receiver	Queue/Exchange
RD Bid Details Requested	Requesting Redispatching Bids to be retrieved	SA	Elia	RedispatchingEnergyBidDetailsRequested.In.Exch

RD Bid Details Retrieved	The result of the requested Redispatching Bids	Elia	SA	RedispatchingEnergyBidDetailsRetrieved.[TargetMarketPartyID].OutQ
RD Bid Details Answered	The answer to the request message	Elia	SA	RedispatchingEnergyBidDetailsAnswered.[TargetMarketPartyID].OutQ

Error queues

This table contains the queues and exchanges to send and receive message only in case of error.

Message Type	Sender	Receiver	Queue/Exchange
RD Bid Details Requested	Elia	SA	RedispatchingEnergyBidDetailsRequested.[TargetMarketPartyID].ErrorQ
RD Bid Details Retrieved	SA	Elia	RedispatchingEnergyBidDetailsRetrieved.Error.Exch
RD Bid Details Answered	SA	Elia	RedispatchingEnergyBidDetailsAnswered.Error.Exch

9.11.3 Energy bid details requested message

9.11.3.1 Message granularity

Requesting Energy Bids will be limited to one execution day and can be filtered using input parameters. If these are not used, all relevant Market Documents for the requested period will be returned. In the retrieval, Elia will send back each Market Document in a separate message.

9.11.3.2 Message timeframe

Requests will be limited in frequency and period for performance reasons as described in the validation rules.

9.11.3.3 Message description

A document [Request MarketDocument](#) is used for the Energy Bid Request.

Field Code Changed

Request_MarketDocument (exactly one element per message)		
Field	Mandatory	Description
mRID	Y	Unique identification of the Request Market Document
type	Y	Type of market document. Z14 = Bid Request
process.processType	Y	Code for type of process: A41 = Redispatch process
sender_MarketParticipant.mRID	Y	The identification of the sender (EIC code)
sender_MarketParticipant.marketRole.type	Y	The role code associated with the sender: Z02 = Scheduling Agent
receiver_MarketParticipant.mRID	Y	The identification number of the sender (EIC code). Fixed value: 10X1001A1001A094 = Elia
receiver_MarketParticipant.marketRole.type	Y	The role code associated with sender. Fixed value: A04 = System Operator
createdDateTime	Y	The date and time of the creation of the Request Market Document

request_Period.timeInterval	Y	The beginning and ending date and time of the period covered by the document. This cannot exceed an execution day.
Request_TimeSeries	Y	Request_TimeSeries contained in the message

Request_TimeSeries		
Field	Mandatory	Description
mRID	Y	Unique identification of the Request_TimeSeries within the market document
flowDirection.direction	Y	The coded identification of the direction of energy flow. A01 = UP A02 = DOWN A03 = UP & DOWN
requested_MarketDocument.mRID	N	The Market Document mRID can be set here if a specific Market Document is requested. If not used, this filter is not applied.
RequestedProvidingGroup	N	The Delivery Points that form the Providing Group to which these bids are related. When used, the exact set of Delivery Points in the Providing Group must match or no results will be returned. If not used, this filter is not applied.

timeInterval		
Field	Mandatory	Description
start	Y	The start date and time of the interval
end	Y	The end date and time of the interval

RegisteredResource		
Field	Mandatory	Description
mRID	Y	EAN code of a DeliveryPoint

9.11.4 Validation of an energy bid details requested message

This information flow will be subject to all generic validation rules. These and the validation rules listed in the table below are further described in the following section of this document: [Validation rules description](#).

Request messages that are rejected will be answered with the Answer message as described in the definition of answer message (see [Acknowledgement and answer messages](#)). When the request is valid, the Energy Bid Retrieval message described in the next section will be returned.

9.11.4.1 Validations on request process

ID	Validation Rule	Reply Status	Reason Code	Level
REQ_001	The request did not generate any results	Accepted with warnings	Y11	MarketDocument

Field Code Changed

Field Code Changed

REQ_002	The number of requests per 15 minutes cannot exceed the threshold limit	Reject message	Y10	MarketDocument
REQ_003	The request can cover maximum one execution day	Reject message	Y09	MarketDocument

9.11.5 Energy bid details retrieved message

9.11.5.1 Message granularity

For bidding, the granularity is set at the Providing Group and the bid execution date level. Meaning that for each combination of these objects, we will send exactly one single message. So if the request requires multiple Providing Groups, these will be split per message, similarly to the bid submission. In the retrieved message we will only send back the last accepted version of a Market Document.

9.11.5.2 Message timeframe

The message(s) will be returned as soon as possible after a valid request was made.

9.11.5.3 Message description

ReserveBid_MarketDocument (exactly one element per message)		
Field	Mandatory	Description
mRID	Y	Unique identification of the MarketDocument (UUID) that was retrieved
revisionNumber	Y	Version number for the market document that was retrieved
type	Y	Type of MarketDocument. Fixed value: A24 = Bid Document
process.processType	Y	Code for type of process: A41 = Redispatch process
sender_MarketParticipant.mRID	Y	The identification number of the sender (EIC code). Fixed value: 10X1001A1001A094 = Elia
sender_MarketParticipant.marketRole.type	Y	The role code associated with sender. Fixed value: A04 = System Operator
receiver_MarketParticipant.mRID	Y	The identification of the sender (EIC code)
receiver_MarketParticipant.marketRole.type	Y	The role code associated with the sender: Z02 = Scheduling Agent
createdDateTime	Y	The date and time of the reception of the Market Document by Elia
reserveBid_Period.timeInterval	Y	The begin and end date and time of the period covered by the document
Bid_TimeSeries	Y	Bid timeseries associated to the market document. It must contain at least one element.

Bid_TimeSeries		
Field	Mandatory	Description
mRID	Y	Unique identification of the bid timeseries within the MarketDocument
status	N	Only used in case of cancellation, with the following code:

		A09 = Cancelled
businessType	Y	Identifies the trading nature of the timeseries: B74 = Offer
bidGroupId	Y	The unique identification used to identify associated bids with each other into a Bid Group. This identification is defined by the sender and must be unique
multipartBidIdentification	N	The identification used to associate parent child bids. If the bid is not part of parent child group then the attribute is not used. This identification is defined by the sender and must be unique
exclusiveBidsIdentification	N	The identification used to associate exclusive bids. If the bid is not exclusive then the attribute is not used. It allows only one element in this list. This identification is defined by the sender and must be unique
ProvidingGroup	Y	The Delivery Points that form the Providing Group to which these bids are related. The list should contain at least one element.
BidGroup	N	The specific Delivery Points to which the Bid Group is related.
flowDirection.direction	Y	The coded identification of the direction of energy flow. A01 = UP A02 = DOWN
activation_ConstraintDuration.duration	N	Full-Activation Time (FAT) (in min) necessary to reach the offered maximum bid volume If no value is provided, a default value of 12,5 minutes will be used.
Maximum_ConstraintDuration.duration	N	Maximum Activation time (MAT) (in min) during which the maximum bid volume can be activated If no value is provided, then there is no limitation on the maximum constraint duration.
Minimum_ConstraintDuration.duration	N	Minimum Activation time (MIT) (in min) during which the bid needs to be activated If no value is provided, then there is no minimum activation time.
Linked_BidTimeSeries	N	List of conditionally linked bid timeseries.
Period	Y	List of periods associated to the timeseries. It should contain at least one element.

Period		
Field	Mandatory	Description
timeInterval	Y	The start and end date and time of the period
resolution	Y	PT15M = 15 minutes

point	Y	List of points associated to the period. It should contain as many points as needed to complete the period.
-------	---	--

Point		
Field	Mandatory	Description
position	Y	The interval number defining which position in the timeseries is indicated. It must start at 1.
Quantity.quantity	Y	The maximum Bid Volume offered in the bid
minimum_Quantity.quantity	N	The minimum volume that must be activated for this bid. If no value is provided, a default of 0 MW will be considered.
energy_Price.amount	Y	Price in euro for each offered MWh
maximum_EnergyLevel.energy	N	The Maximum Energy Level (MEL) indicates the maximum remaining energy for the Providing Group. If no value is provided, no limitation will be considered.
PointGroup	N	The specific delivery points to which the interval of this bid is related.
Reason	N	List of reasons associated to the point. Maximum one element.

Linked_BidTimeSeries		
Field	Mandatory	Description
mRID	Y	The bidGroupID to which the conditional link refers to
status	Y	The condition of the conditional linked bid: A55 = Not available if linked bid activated A56 = Not available if linked bid rejected A67 = Available if linked bid activated A68 = Available if linked bid rejected
level	Y	The level determines the position of the bid within the linked Bid Group with respect to the current bid: 1 = refers to t-1 of the linked bid with respect to the current position of this bid 2 = refers to t-2 of the linked bid with respect to the current position of this bid

RegisteredResource		
Field	Mandatory	Description
mRID	Y	EAN code of a DeliveryPoint

Reason		
Field	Mandatory	Description
code	Y	Y24 = Forced Outage

timeInterval		
Field	Mandatory	Description
start	Y	The start date and time of the interval
end	Y	The end date and time of the interval

9.11.6 Energy bid details answered message

The bid answered message for Energy bid details requested is identical to the bid answered message of Redispatching Bids.

As described in the definition of answer message (see [Acknowledgement and answer messages](#)).

Field Code Changed

10 Balancing Service Provider Guide

10.1 Role overview

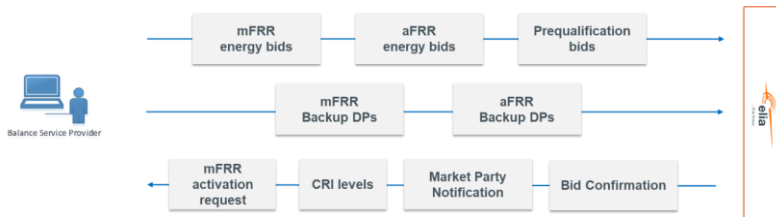

A Balancing Service Provider is involved in the following communications:

- Submission of bids (mFRR)
 - o Submission of mFRR Energy Bids
 - o Submission of mFRR backup Delivery Points
- Activation of mFRR Energy Bids (mFRR)
- Submission of bids (aFRR)
 - o Submission of aFRR Energy Bids
 - o Submission of aFRR backup Delivery Points
- Common information flows (BSP)
 - o Prequalification bids
 - o Receiving bid confirmations
 - o CRI-levels² sent by Elia
 - o Market Party notifications sent by Elia

10.2 Bid structure

This specific section aims to give some clarifications on how to construct Energy Bids.

A general rule is that all Energy Bids for a certain **execution date** and a certain **Providing Group** must be sent in a single message per sent version. An Energy Bid is defined for a particular quarter-hour and must be grouped into Bid Groups.



² CRI with high to medium levels are the equivalent of the currently known Red Zones

10.2.1 Bid groups

Energy Bids representing the **same or partly the same offered volume over consecutive quarter-hours** must be grouped into Bid Groups using a Bid Group Id on the corresponding Timeseries level of the message. This grouping will technically link³ the Energy Bids together in order to avoid unfeasible activations⁴. The Energy Bids that are subject to mFRR and redispatching activations will be activated based on the Bid Group Id, the start and end time of activation and the direction.

The Bid Group must be used to link the upward and downward aFRR Energy Bid Volume of a Providing Group. In a providing group, if the BSP creates an upward and a downward bid volume, they need to be part of the same Bid Group to avoid unfeasible activations of those two volumes.

10.2.2 Timeseries

As in each CIM message, the Timeseries block is used as a parent level in the message structure and encapsulates the periods and points (representing the actual Energy Bids across time). As long as the attributes on Timeseries level are applicable for the underlying QH bids of a Bid Group, there is no need to split the Timeseries blocks.

Note however that for Bid Groups that are not split in different Timeseries blocks during the execution date, a technical link is necessary between different messages if the Energy Bids that are consecutive across midnight represent (partly) the same volume. In this case, the same Bid Group Id must be used in these different messages.

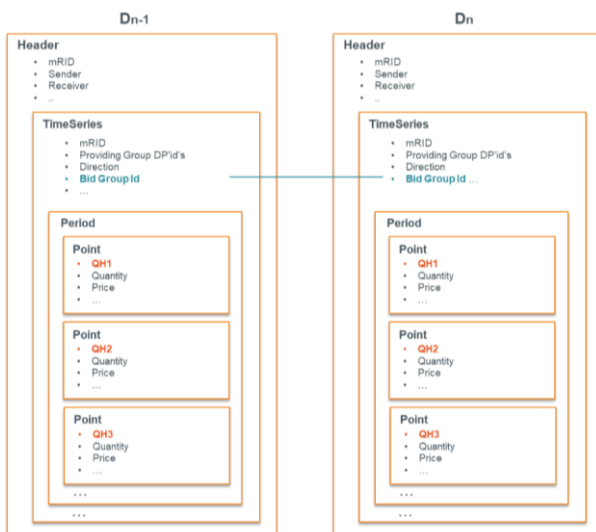

³ Energy Bids that are part of a same Bid Group/that have the same Bid Group ID will be technically linked so that the activation of a bid will be prevented in case the technically linked bid of the previous QH was activated in Direct Activation.

⁴ Check 10.2.3 for the application of the Technical Link in the specific case of Exclusive Groups and Parent-Child relations.

When attributes on Timeseries level are different for certain periods during the execution date of a same Bid Group, the Timeseries block can be split into multiple block(s) so that the necessary attributes can be applied to the respective period(s) of the day.

Note that in this case, a technical link is necessary between different messages **and** between Timeseries blocks of the same message for consecutive QH bids that represent (partly) the same volume.



10.2.3 Linking

Exclusive and parent child linking apply to bids of the same quarter hours. This linking must be done in a similar way to Bid Grouping, using the respective attribute (exclusiveBidsIdentification; multipartBidIdentification) on the different timeseries blocks that need to be linked. For exclusive groups and parent-children, the exclusiveBidsIdentification or multipartBidIdentification will be used to technically link bids. Indeed, all bids that are part of a definite exclusive group (or part of a parent-child) quarter-hour after quarter-hour should be technically linked together to prevent unfeasible activations as defined in the below example. To allow this mechanism to take place, the BSP should use the same exclusiveBidsIdentification or multipartBidIdentification respectively for the exclusive groups or parent-children for which he wants the technical link to be applied.

Example: A unit has a total of 30MW to offer for all QH of a day. It offers it in 3 bids of respectively 10, 20 and 30MW that are part of the same exclusive group and that have a different price. We activate in QH1 the bid of 30MW in direct activation. The principle is that either one or none of the bids of an exclusive group can be activated for a definite quarter-hour so the two other bids will not be activated which is logical in our example. Because if we would activate the bid of 10MW and the bid of 30MW in one QH, we would exceed the volume that the BSP has to offer. The direct activation will last up to the end of QH2. This means that in QH2, we can also not activate any of the bid of the exclusive group because we would also then exceed the total volume that the unit has to offer for that QH. To prevent this, all bids from the exclusive group will be technically linked with the bids of the same exclusive group offered in the previous QH.

For conditional linking, which like technical linking applies to different quarter hours, it is necessary to use the LinkedBid Timeseries block. In this block you can define the Bid Group Id to which the conditional link relates, the status and the level.

The levels will determine the amount of quarter hours linked to in time. Level 1 links to the previous quarter hour and level 2 to two quarter hours before. As the link is done on Bid Group level, they apply to all quarter hour bids that can be linked in time between the two Bid Groups.

In the following you can see two conditional links that are representing respectively level 1 and level 2 QH linking.

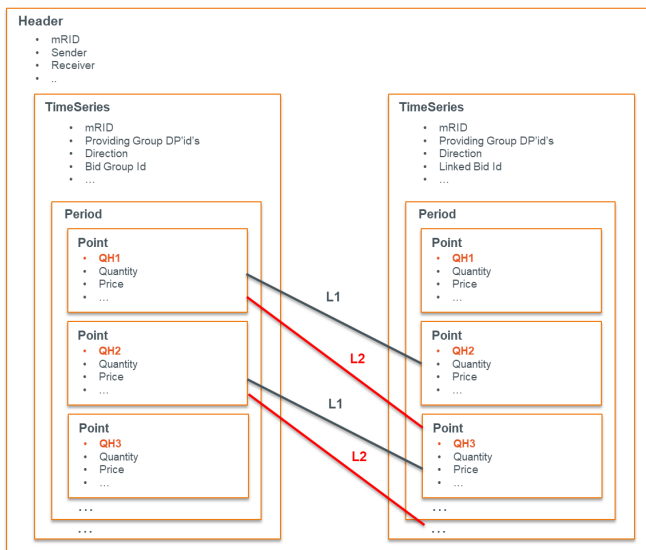

10.2.4 Delivery Points

A Providing Group comprises any set of Delivery Points that can be offered together in an Energy Bid. The bid structure allows to define the Delivery Points (DPs) to which the bids relate to at three levels. All bids inherit the Delivery Points identified in the Providing Group unless a deeper level is used to identify Delivery Points. The same goes for Bid Group and Bid level where, if Delivery Points are identified in the latter, the Point Group (bid) Delivery Points will be used.

1. **Providing Group level:** all Delivery Points used for bids within the message must always be defined at Providing Group level.



→ Bids of Bid Group 1 & 2 are based on Providing Group DPs

2. **Bid Group level:** when Delivery Points are identified on Bid Group level, they only relate to the bids defined within this Bid Group. This level is useful to bid on different operating modes for example.

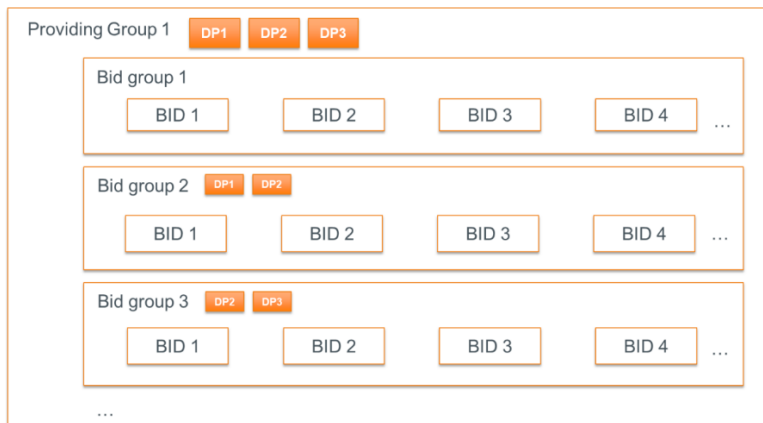

→ Bids of Bid Group 1 are based on Providing Group DPs

→ Bids of Bid Group 2 & 3 are based on their respective DPs

3. **Bid level:** when the Delivery Points are identified on Bid (Point Group) level, they apply to a specific bid. This level can be used to change the composition of the Delivery Points for (a/some) specific quarter hour(s) of a Timeseries block without having to split it.

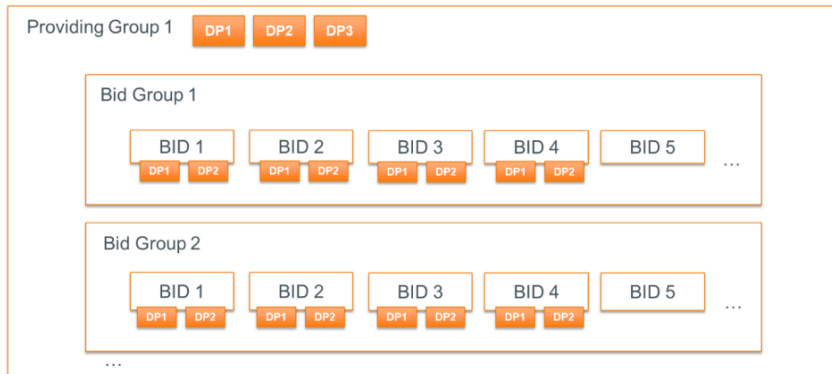

- Bid 1 to Bid 4 relate to DPs specified on those bids
- Bid 5 onwards relate to Providing Group DPs

10.3 Submission of mFRR Energy Bids

10.3.1 Description

This information flow describes the process of submitting bids to the External Communication Layer.

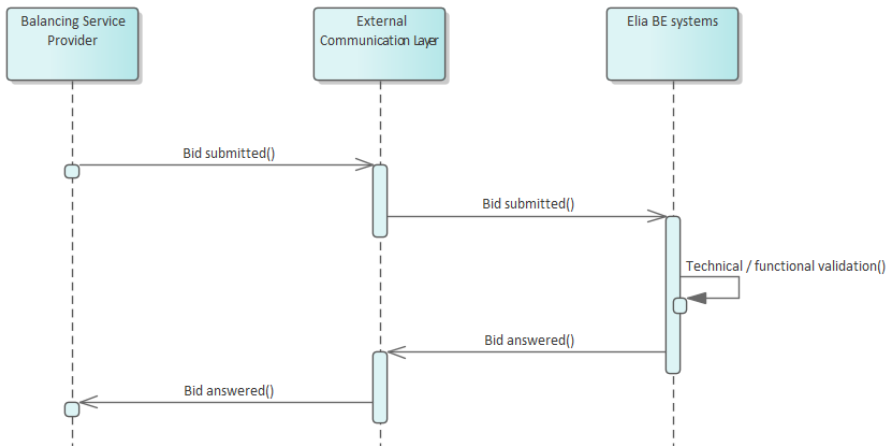

The Balancing Service Provider will send a bid message asynchronously to Elia. The External Communication Layer will treat the message in an asynchronous manner and will reply to it with the result of the validation done in the Elia backend systems.

10.3.2 Queue information

This table contains the queues and exchanges to send and receive messages in a normal scenario:

Message Type	Description	Sender	Receiver	Queue/Exchange
mFRR Bid Submitted	Submission of new bid or bid update	BSP	Elia	mFRREnergyBidSubmitted.In.Exch
mFRR Bid Answered	Answer to a bid message	Elia	BSP	mFRREnergyBidAnswered.[TargetMarketPartyID].OutQ

Error queues

This table contains the queues and exchanges to send and receive message only in case of error:

Message Type	Sender	Receiver	Queue/Exchange
mFRR Bid Submitted	Elia	BSP	mFRREnergyBidSubmitted.[TargetMarketPartyID].ErrorQ
mFRR Bid Answered	BSP	Elia	mFRREnergyBidAnswered.Error.Exch

10.3.3 Bid submitted message

10.3.3.1 Message granularity

For bidding, the granularity is set at the **Providing Group** and the **bid execution date** level. Meaning that for each combination of these objects, we expect exactly one single message per sent version.

10.3.3.2 Message timeframe

mFRR bids can be submitted between D-7 and BE GCT. Updates are allowed after BE GCT for certain reasons that have to be indicated in the message.

For timings on obligation of submission of contracted volumes please refer to the contract.

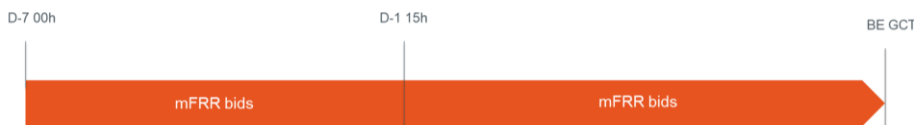

10.3.3.3 Message description

A [ReserveBid_MarketDocument](#) is the message that must be used in order to submit the bids.

Field Code Changed

Optional fields of the MarketDocument that are not described in this chapter cannot be used.

ReserveBid_MarketDocument (exactly one element per message)		
Field	Mandatory	Description
mRID	Y	Unique identification of the MarketDocument (UUID)
revisionNumber	Y	Version number for the market document
Type	Y	Type of MarketDocument. Fixed value: A24 = Bid Document
process.processType	Y	Code for type of process: A47 = Manual frequency restoration reserve
sender_MarketParticipant.mRID	Y	The identification of the sender (EIC code)
sender_MarketParticipant.marketRole.type	Y	The role code associated with the sender: A46 = Balancing Service Provider
receiver_MarketParticipant.mRID	Y	The identification of the receiver (EIC code). Fixed value: 10X1001A1001A094 = Elia
receiver_MarketParticipant.marketRole.type	Y	The role code associated with the receiver: A04 = System Operator
createdDateTime	Y	The date and time of the creation of the document
reserveBid_Period.timeInterval	Y	The begin and end date and time of the period covered by the document
Bid_TimeSeries	Y	Bid timeseries associated to the market document. It must contain at least one element.

Bid_TimeSeries		
Field	Mandatory	Description
mRID	Y	Unique identification of the bid timeseries within the MarketDocument
Status	N	Only used in case of cancellation, with the following code: A09 = Cancelled

auction.mRID	Y	Possible values : Z01 = Non-contracted Z02 = Contracted
businessType	Y	Identifies the trading nature of the timeseries: B74 = Offer
bidGroupld	Y	The unique identification used to identify associated bids with each other into a Bid Group. This identification is defined by the sender and must be unique
multipartBidIdentification	N	The identification used to associate parent child bids. If the bid is not part of parent child group then the attribute is not used. This identification is defined by the sender and must be unique
exclusiveBidsIdentification	N	The identification used to associate exclusive bids. If the bid is not exclusive then the attribute is not used. It allows only one element in this list. This identification is defined by the sender and must be unique
ProvidingGroup	Y	The Delivery Points that form the Providing Group to which these bids are related. The list should contain at least one element.
BidGroup	N	The specific Delivery Points to which the Bid Group is related.
flowDirection.direction	Y	The coded identification of the direction of energy flow. A01 = UP A02 = DOWN
maximum_ConstraintDuration.duration	N	Maximum Activation time (MAT) (in min) during which the maximum bid volume can be activated If no value is provided, then there is no limitation on the maximum constraint duration.
Neutralization_Duration.duration	N	If the activation of a bid is not prolonged, the Neutralization Time (NT) (in min) is the time during which the bid volume cannot be activated after a previous activation If no value is provided, then there is no neutralization time.
Linked_BidTimeSeries	N	List of conditionally linked bid timeseries. There is a maximum of 6 elements allowed in this list.
Period	Y	List of periods associated to the timeseries. It should contain at least one element.

Period		
Field	Mandatory	Description
timeInterval	Y	The start and end date and time of the period
Resolution	Y	PT15M = 15 minutes
Point	Y	List of points associated to the period.

		It should contain as many point as needed to complete the period.
--	--	---

Point		
Field	Mandatory	Description
Position	Y	The interval number defining which position in the timeseries is indicated. It must start at 1.
Quantity.quantity	Y	The maximum Bid Volume offered in the bid
minimum_Quantity.quantity	N	The minimum volume that must be activated for this bid. If no value is provided, a default of 0 MW will be considered.
energy_Price.amount	Y	Price in euro for each offered MWh
maximum_EnergyLevel.energy	N	The Maximum Energy Level (MEL) indicates the maximum remaining energy for the Providing Group. If no value is provided, no limitation will be considered.
Standard_MarketProduct.marketProductType	N	Possible values: A05 = Standard mFRR product eligible for scheduled activation only A07 = Standard mFRR product eligible for scheduled and direct activation If no value is provided, a default value of A07 will be used.
PointGroup	N	The specific delivery points to which the interval of this bid is related.
Reason	N	List of reasons associated to the point. Maximum one element.

Linked_BidTimeSeries		
Field	Mandatory	Description
mRID	Y	The bidGroupid to which the conditional link refers to
status	Y	The condition of the conditional linked bid: A55 = Not available if linked bid activated A56 = Not available if linked bid rejected A57 = Not available for DA if linked bid subject to DA A58 = Not available for DA if linked bid subject to SA A59 = Not available if linked bid subject to SA A60 = Not available if linked bid subject to DA A67 = Available if linked bid activated A68 = Available if linked bid rejected A69 = Available if linked bid subject to SA A70 = Available if linked bid subject to DA A71 = Available for DA if linked bid subject to DA A72 = Available for DA if linked bid subject to SA
level	Y	The level determines the position of the bid within the linked Bid Group with respect to the current bid:

		1 = refers to t-1 of the linked bid with respect to the current position of this bid 2 = refers to t-2 of the linked bid with respect to the current position of this bid
--	--	--

RegisteredResource		
Field	Mandatory	Description
mRID	Y	EAN code of a DeliveryPoint

Reason		
Field	Mandatory	Description
code	Y	<p>Y24 = Forced Outage The concerned contracted or non-contracted mFRR Energy Bid is impacted by a Forced Outage.</p> <p>B46 = Internal Congestion (DP activated for redispatching) A Redispatching Energy Bid, provided by a Delivery Point Dpsu also included in the concerned non-contracted mFRR Energy Bid, is activated by ELIA.</p> <p>Y25 = Other The concerned non-contracted mFRR Energy Bid contains (a) Delivery Point(s) that is (are) operated to balance the perimeter of the concerned BRP (i.e. for self-balancing), to balance the ELIA LFC Block (i.e. for reactive balancing) or to perform a trade on the intraday market.</p>

timeInterval		
Field	Mandatory	Description
start	Y	The start date and time of the interval
end	Y	The end date and time of the interval

10.3.4 Validation of a bid submitted message

This information flow will be subject to all generic validation rules. These and the validation rules listed in the table below are further described in the following section of this document: [Validation rules description](#).

All threshold values used in the validation rules are subject to change and will be defined in the contract.

10.3.4.1 Validations on bid structure and time

ID	Validation Rule	Reply Status	Reason Code	Level
BID_001	The time period of the message must exactly cover one day	Reject message	Y86	MarketDocument
BID_002	All timeseries within the same message must have the same Providing Group	Reject message	Y84	MarketDocument

Field Code Changed

BID_003	The bid timeseries period interval must be a multiple of the resolution (default 15 min)	Reject message	A41	Timeseries
BID_004	No overlap of periods allowed for timeseries of the same Bid Group	Reject message	Y83	Timeseries
BID_005	The same MarketDocument mRID must be used per Providing Group, per MarketDocument time interval	Reject message	Y82	MarketDocument
BID_007	The Maximum Activation Time (MAT) must be a multiple of 15 minutes	Reject message	Y80	Timeseries
BID_065	It is not allowed to change the cancellation status for timeseries that have bids in the past	Reject message	Y14	Timeseries
BID_066	It is not allowed to list a Delivery Point on Energy Bids for the same quarter hour in different Providing Groups	Reject message	Y79	Timeseries
BID_067	The Neutralization Time (NT) must be a multiple of 15 minutes	Reject message	Y05	Timeseries
BID_074	Updates for Bids for which an activation request has been sent are not allowed	Reject message	X96	Timeseries
BID_080	The Maximum Energy Level for bids of the same providing group must be the same per direction and per quarter hour	Reject message	X92	Timeseries
BID_081	If a Maximum Energy Level is defined for a bid, then it must be defined for all bids from the Providing Group	Reject message	X91	Timeseries
BID_082	The Maximum Energy Level must be greater than or equal to zero	Reject message	X90	Timeseries
BID_083	Bids cannot have both a Maximum Energy Level and a Maximum Activation Time	Reject message	X89	Timeseries
BID_085	All bids from the same Bid Group must have the same direction	Reject message	X87	Timeseries

10.3.4.2 Validations on Delivery Point

ID	Validation Rule	Reply Status	Reason Code	Level
BID_009	The Delivery Points of the Bid Group must belong to the Providing Group, if the Bid Group is defined	Reject message	Y78	Timeseries
BID_010	The Delivery Points in a specific quarter hour bid must belong to the Providing Group	Reject message	Y77	Timeseries
BID_011	The BSP must have a valid BSP mFRR contract and all Delivery Points must be included in the pool of the BSP.%EAN%	Reject message	Y76	MarketDocument
BID_012	If a DP _{SU} Delivery Point is included in the Providing Group, then all other Delivery Points from that Providing Group must belong to the same Technical Facility	Reject message	Y75	MarketDocument
BID_013	A DP _{PG} Delivery Point cannot be listed in an aFRR bid or as an aFRR backup Delivery Point for the same quarter hour on the same execution date	Reject message	Y57	Timeseries

BID_014	A Delivery Point cannot be listed as a Prequalification Bid for the same execution date	Reject message	Y56	MarketDocument
BID_059	The Delivery Points in a specific quarter hour bid must belong to the Bid Group, if the Bid Group is defined	Reject message	Y21	Timeseries

10.3.4.3 Validations on Bid Volume

ID	Validation Rule	Reply Status	Reason Code	Level
BID_015	The Minimum Bid Volume must be greater than or equal to zero and must be smaller than or equal to the Bid Volume	Reject message	Y74	Timeseries
BID_016	The Bid Volume must be greater than or equal to zero	Reject message	Y73	Timeseries
BID_017	For bids submitted before Gate Closure Time the Bid Volume must be greater than or equal to 1 MW	Reject message	Y72	Timeseries
BID_018	Bid Volume granularity is equal to 1 MW	Reject message	Y71	Timeseries
BID_019	Minimum Bid Volume granularity is equal to 1 MW	Reject message	Y70	Timeseries
BID_020	The Bid Volume must be smaller than or equal to the sum of the values of $DP_{mFRR,max}$	Reject message	Y69	Timeseries
BID_021	Per Providing Group composed of DP_{pg} , the Bid Volume must be smaller than or equal to 100 MW	Reject message	Y54	MarketDocument

10.3.4.4 Validations on Bid Price

ID	Validation Rule	Reply Status	Reply Code	Level
BID_026	Bid Price granularity is equal to 0,01 €/MWh	Reject message	Y68	Timeseries
BID_027	The Bid Price must be greater than or equal to a minimum threshold price and must be smaller than or equal to a maximum threshold price	Reject message	B51	Timeseries
BID_028	A warning will be given if the Bid Price falls out of a threshold range determined by Elia	Accepted with warning	Y67	Timeseries

10.3.4.5 Validations on bid linking

ID	Validation Rule	Reply Status	Reason Code	Level
BID_029	Bids with the same parent-child identification must have the same Providing Group	Reject message	Y66	Timeseries
BID_030	Bids with the same parent-child identification must have the same direction	Reject message	Y65	Timeseries
BID_031	Bids with the same parent-child identification must have the same activation type	Reject message	Y53	Timeseries

BID_032	Bids with the same parent-child identification must have different Bid Prices	Reject message	Y64	Timeseries
BID_033	Bids with a parent-child identification cannot have any conditionally linked bid timeseries	Reject message	Y63	Timeseries
BID_034	Bids with an exclusive bid identification cannot have any conditionally linked bid timeseries	Reject message	Y52	Timeseries
BID_035	Bids can have maximum one exclusive bid identification	Reject message	Y51	Timeseries
BID_036	Bids cannot have both an exclusive bid identification and a parent-child identification	Reject message	Y62	Timeseries
BID_037	A maximum of six conditionally linked bid timeseries can be provided. A maximum of three in level 1 and three in level 2.	Reject message	Y50	Timeseries
BID_038	The number of bids in one exclusive group must be smaller than or equal to a specific value for every quarter hour	Reject message	Y49	MarketDocument
BID_039	The number of exclusive groups in every quarter hour must be smaller than or equal to specific value	Reject message	Y48	MarketDocument
BID_040	No technical linking is allowed across Providing Groups	Reject message	Y41	Timeseries
BID_060	Bids with the same exclusive bid identification must have the same activation type	Reject message	Y20	Timeseries
BID_068	Bids cannot be conditionally available and conditionally unavailable at the same time	Reject message	Y04	Timeseries
BID_077	Conditionally linked bid timeseries must exist	Accepted with warning	X95	Timeseries
BID_078	Bids cannot be conditionally linked more than once to a given bid	Reject message	X94	Timeseries
BID_079	Bids cannot be cancelled if the Energy Bid is used in a conditional link	Reject message	X93	Timeseries
BID_084	Bids with the same parent-child or exclusive group identification must have the same availability status	Accepted with warning	X88	Timeseries
BID_086	It is not allowed to update the Bid Group Id of existing timeseries	Reject message	X85	Timeseries

10.3.4.6 Validations on timelines

ID	Validation Rule	Reply Status	Reason Code	Level
BID_042	No new bids can be submitted after Gate Closure Time	Reject message	Y47	Timeseries
BID_043	If bids are updated after BE GCT it is only allowed to reduce the Bid Volume. All other properties must remain unchanged.	Reject message	Y59	Timeseries
BID_045	If bids are updated after BE GCT a reason needs to be provided	Reject message	Y58	Timeseries
BID_047	If the Bid Volume is reduced after BE GCT, a warning will be provided to the BSP	Accepted with warning	Y46	Timeseries
BID_048	The execution date in the message must be greater than or equal to the current date and must be smaller than or equal to current date + 7 days	Reject message	Y60	MarketDocument

BID_058	If contracted energy bids are updated after BE GCT a reason 'Forced Outage' needs to be provided	Reject message	Y58	Timeseries
BID_075	mFRR Energy Bids cannot be updated later than 5 minutes after the start of the validity period of the bid	Reject message	Y22	Timeseries

10.3.4.7 Validations linked to congestion

ID	Validation Rule	Reply Status	Reason Code	Level
BID_062	Increasing Bid Volume by submitting new or updated non contracted Energy Bids containing Delivery Points located in an electrical zone with a medium or high CRI level may be subject to filtering	Accepted with warning	Y19	Timeseries
BID_063	Increasing Bid Volume by submitting new or updated contracted Energy Bids containing Delivery Points located in an electrical zone with a medium or high CRI level is not allowed	Reject	Y16	Timeseries

10.3.5 Bid answered message

The bid answers are submitted by Elia and received by the BSP.

Note: no acknowledgement of an answer is supported

10.3.5.1 Message granularity

One answer will be sent by Elia for each bid submitted message submitted by the BSP.

10.3.5.2 Message timeframe

The confirmation message will be sent as soon as the bid message has been received and processed by Elia.

10.3.5.3 Message description

As described in the definition of answer message (see [Acknowledgement and answer messages](#)).

Field Code Changed

10.4 Submission of mFRR backup Delivery Points

10.4.1 Description

This message allows Market Parties to submit a list of backup Delivery Points for mFRR bids. The message contains a list of backup Delivery Points per quarter hour for an execution date. The list of backup Delivery Points is not linked to any specific bid, any Bid Group or any Providing Group.

This information flow describes the process of providing backup Delivery Points.

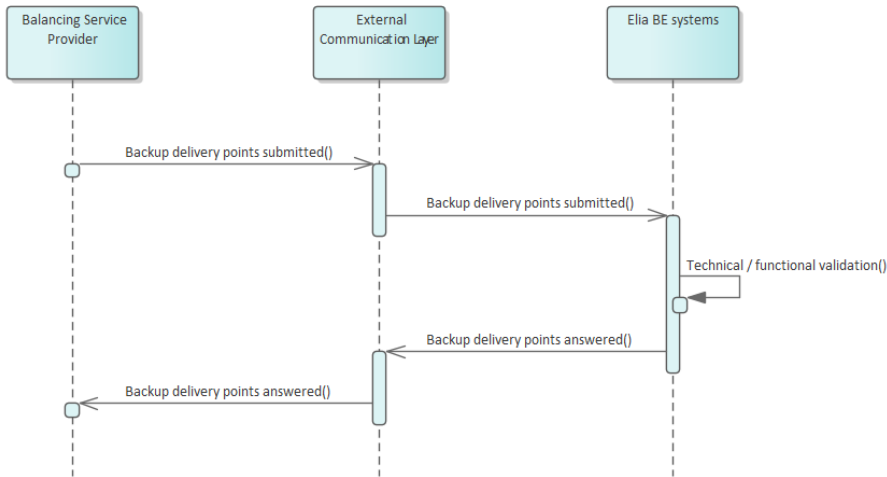

10.4.2 Queue information

This table contains the queues and exchanges to send and receive messages in a normal scenario:

Message Type	Description	Sender	Receiver	Queue/Exchange
mFRR Backup Delivery Points Submitted	Submission of new mFRR backup Delivery Points or backup Delivery Points update	BSP	Elia	mFRRBackupDeliveryPointSubmitted.In.Exch
mFRR Backup Delivery Points Answered	Answer to an mFRR backup Delivery Points message	Elia	BSP	mFRRBackupDeliveryPointAnswered.[TargetMarketPartyID].OutQ

Error queues

This table contains the queues and exchanges to send and receive message only in case of error:

Message Type	Sender	Receiver	Queue/Exchange
mFRR Backup Delivery Points Submitted	Elia	BSP	mFRRBackupDeliveryPointSubmitted.[TargetMarketPartyID].ErrorQ
mFRR Backup Delivery Points Answered	BSP	Elia	mFRRBackupDeliveryPointAnswered.Error.Exch

10.4.3 mFRR backup Delivery Points submitted message

10.4.3.1 Message granularity

The granularity of the backup Delivery Point message is set at **execution date** level. Meaning that a message per execution date can be sent, containing a list of backup Delivery Points for that date.

10.4.3.2 Message timeframe

Backup Delivery Point messages can be submitted from gate opening time, which is D-7, until Gate Closure Time.

10.4.3.3 Message description

A document [BackupDeliveryPoints_MarketDocument](#) is used for the mFRR backup Delivery Points message.

Field Code Changed

BackupDeliveryPoints_MarketDocument (exactly one element per message)		
Field	Mandatory	Description
mRID	Y	Unique identification of the market document
revisionNumber	Y	Version number for the market document
type	Y	Type of market document. Fixed value: Z09 = Backup Delivery Points Document
process.processType	Y	A47 = Manual frequency restoration reserve
sender_MarketParticipant.mRID	Y	The identification ID of the sender (EIC code)
sender_MarketParticipant.marketRole.type	Y	The role code associated with sender A46 = Balancing Service Provider
receiver_MarketParticipant.mRID	Y	The identification number of the receiver (EIC code) 10X1001A1001A094 = Elia
receiver_MarketParticipant.marketRole.type	Y	The role code associated with receiver. A04 = System Operator
createdDateTime	Y	The date and time of the creation of the document
backupDeliveryPoints_Period.timeInterval	Y	The beginning and ending date and time of the period covered by the document
BackupDeliveryPoints_TimeSeries	Y	BackupDeliveryPoints_TimeSeries contained in the message. This list can only contain one element

BackupDeliveryPoints_TimeSeries		
Field	Mandatory	Description
mRID	Y	Unique identification of the BackupDeliveryPoints_TimeSeries within the market document
Period	Y	List of Period

Period		
Field	Mandatory	Description
timeInterval	Y	The start and end date and time of the period
resolution	Y	Amount of time for each interval in which a data value is defined. Fixed value: PT15M = 15 minutes
Point	Y	List of Point

Point		
Field	Mandatory	Description
position	Y	The interval number defining which position in the period is indicated
PointGroup	N	List of backup Delivery Points for the quarter hour. In order to cancel (all) backup Delivery Points, it is allowed to leave the PointGroup empty

RegisteredResource

Field	Mandatory	Description
mRID	Y	EAN code of a DeliveryPoint

timeInterval		
Field	Mandatory	Description
start	Y	The start date and time of the interval
end	Y	The end date and time of the interval

10.4.4 Validation of an mFRR backup Delivery Points submitted message

This information flow will be subject to all generic validation rules. These and the validation rules listed in the table below are further described in the following section of this document: [Validation rules description](#).

All threshold values used in the validation rules are subject to change and will be defined in the contract.

ID	Validation Rule	Reply Status	Reason Code	Level
BACK_001	The time period of the message must exactly cover one day	Reject message	Y86	MarketDocument
BACK_002	The combination of MarketDocument mRID and the sender marketParty mRID must be unique per MarketDocument time interval	Reject message	Y44	MarketDocument
BACK_003	The BSP must have a valid BSP mFRR contract and all Delivery Points must be included in the pool of the BSP	Reject message	Y76	MarketDocument
BACK_004	The DP _{PG} backup Delivery Points cannot be listed in an aFRR bid or as an aFRR backup Delivery Point on the same quarter hour on the same execution date	Reject message	Y43	Timeseries
BACK_006	The backup Delivery Points cannot be listed in a Prequalification Bid on the same execution date	Reject message	Y43	Timeseries
BACK_007	Updates to backup Delivery Points after Gate Closure Time are not allowed	Reject message	Y12	Timeseries

Field Code Changed

10.4.5 mFRR backup Delivery Points answered message

10.4.5.1 Message granularity

One answer will be sent by Elia for each mFRR backup Delivery Points submitted message submitted by the BSP.

10.4.5.2 Message timeframe

The confirmation message will be sent as soon as the mFRR backup Delivery Points message has been received and processed by Elia.

10.4.5.3 Message description

As described in the definition of answer message (see [Acknowledgement and answer messages](#)).

Field Code Changed

10.5 Submitting schedule update for mFRR baseline

10.5.1 Description

This information flow describes the process of schedule update submission.

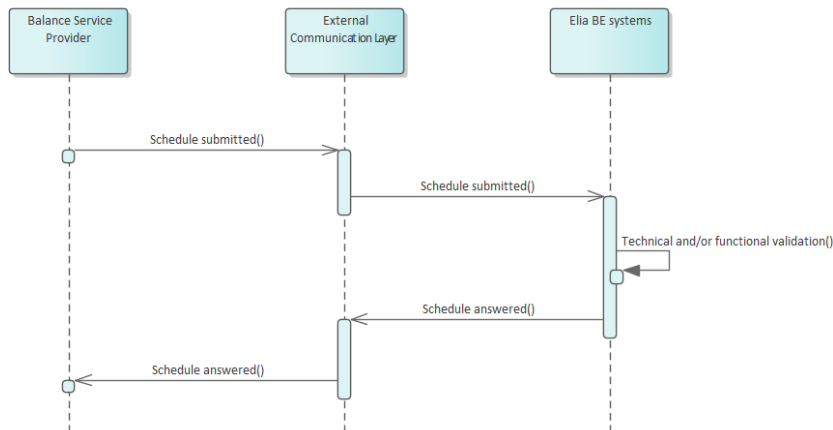

Schedule updates for mFRR baseline can be sent and updated via a schedule submitted message. The External Communication Layer will treat the message in an asynchronous manner and will reply to it with the result of the validation done in the Elia backend systems.

10.5.2 Queue information

This table contains the queues and exchanges to send and receive messages in a normal scenario:

Message Type	Description	Sender	Receiver	Queue/Exchange
Schedule Update Submitted Message	Submission of schedule update	BSP	Elia	ScheduleBaselineUpdateSubmitted.In.Exch
Schedule Update Answered Message	Answer to a schedule update submitted message	Elia	BSP	ScheduleBaselineUpdateAnswered.[TargetMarketPartyID].OutQ

Error queues

This table contains the queues and exchanges to send and receive message only in case of error:

Message Type	Sender	Receiver	Queue/Exchange
Schedule Update Submitted	Elia	BSP	ScheduleBaselineUpdateSubmitted.[TargetMarketPartyID].ErrorQ
Schedule Update Answered	BSP	Elia	ScheduleBaselineUpdateAnswered.Error.Exch

10.5.3 Schedule submitted message

10.5.3.1 Message granularity

For scheduling, the granularity is set at the **delivery point** and the **schedule execution date**. Meaning that for each combination of these objects, we expect exactly one single message per sent version.

For schedule update messages Elia is expecting the same market document mRID to be used per delivery point and schedule execution date. It is possible to send multiple versions of the market document throughout the day to make updates.

10.5.3.2 Message timeframe

To allow the right context, the timeframe in which the schedule update is expected is described here. Note however that the exact timings are described in the contract of which the information always prevails.

- Schedule updates can only be sent after T – 45 min on the execution date (Redispatching GCT) up to T + 5 minutes (5 minutes after the start of the quarter hour).

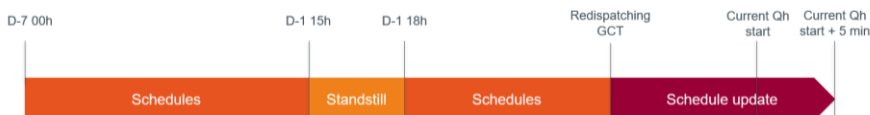

10.5.3.3 Message description

A [Schedule_MarketDocument](#) is the message that must be used in order to submit the schedules.

Optional fields of the MarketDocument that are not described in this chapter cannot be used.

Schedule_MarketDocument (Exactly one element per message)		
Field	Mandatory	Value(s)
mRID	Y	Unique identification of the market document (UUID)
revisionNumber	Y	Version number for the market document
type	Y	Type of market document. Fixed value: A46 = Active Power Schedule Update Document
process.processType	Y	Code for type of process: A17 = Schedule day
process.classificationType	Y	Defines whether the schedule is an aggregation or a classification. Fixed value: A01 = detail type
sender_MarketParticipant.mRID	Y	The identification of the sender (EIC code)
sender_MarketParticipant.marketRole.type	Y	The role code associated with sender: A46 = Balancing Service Provider
receiver_MarketParticipant.mRID	Y	The identification of the receiver (EIC code). Fixed value: 10X1001A1001A094 = Elia
receiver_MarketParticipant.marketRole.type	Y	The role code associated with receiver. Fixed value: A04 = System Operator
createdDateTime	Y	The timestamp on which the message was sent
schedule_Time_Period.timeInterval	Y	The start and end date and time of the day to which the schedule refers to (execution date)

Field Code Changed

domain.mRID	Y	10YBE-----2 = Belgian bidding zone
TimeSeries	Y	This list only allows 1 element

TimeSeries		
Field	Mandatory	Value(s)
mRID	Y	Sender's identification of the timeseries.
Version	Y	Fixed value: 1
businessType	Y	Identifies the trading nature of the timeseries: Z12 = Net Consumption – Production
product	Y	The energy product of the schedule timeseries. Fixed value: 8716867000016 = active power
objectAggregation	Y	Identifies how the object is aggregated. Fixed value: Z01 = Delivery Point
registeredResource.mRID	Y	The delivery point EAN representing the point for which the schedule is sent
measurement_Unit.name	Y	MAW = expressed scheduled power is in Megawatt
Period	Y	This list only allows 1 element

Period		
Field	Mandatory	Value(s)
timeInterval	Y	The start and end date and time to which the schedule timeseries refer to
resolution	Y	Amount of time for each interval in which a data value is defined. Fixed value: PT15M = 15 minutes
Point	Y	List of points associated to the period. It should contain as many point as needed to complete the period.

Point		
Field	Mandatory	Value(s)
position	Y	The interval number defining which position in the timeseries is indicated. It must start at 1.
Quantity	Y	The list of schedule intervals in which the value (MW) of the scheduled power is given. We require an accuracy of 0.1 MW.

timeInterval		
Field	Mandatory	Value(s)
start	Y	The start date and time of the interval
end	Y	The end date and time of the interval

10.5.4 Validation of a schedule submitted message

This information flow will be subject to all generic validation rules. These and the validation rules listed in the table below are further described in the following section of this document: [Validation rules description](#).

Field Code Changed

ID	Validation Rule	Reply Status	Reason Code	Level
SCH_002	Scheduled power must be within technical capacity	Accept with warning	Y92	Timeseries
SCH_004	The MW schedule must be expressed in one fraction digit	Reject	Y90	Timeseries
SCH_005	A schedule cannot be updated in the opposite direction of a redispatching activation on the same period	Reject	Y89	Timeseries
SCH_007	Update requested in violation with a Must Run or May Not Run status is not allowed.	Reject	Y87	Timeseries
SCH_008	The MarketDocument time period must exactly cover the full calendar day	Reject	Y86	MarketDocument
SCH_012	The Delivery Point must be included in a BSP contract valid on the execution date for this Balancing Service Provider	Reject	Y102	Timeseries
SCH_013	The schedule update can only cover the quarter hours between Redispatching GCT and the start of the current Qh + 5 minutes	Reject	Y103	Timeseries
SCH_014	Schedule updates in the direction of a medium or high CRI level are not allowed	Reject	Y104	Timeseries
SCH_015	Incremental update requested during a storm is not allowed	Reject	Y100	Timeseries
SCH_016	Schedule updates for mFRR baseline are not allowed in case no valid schedule has been submitted by the Scheduling Agent	Reject	Y106	Timeseries
SCH_017	Schedule updates for mFRR baseline are not allowed for quarter hours where an (partial) FO has been submitted by the Scheduling Agent	Reject	Y105	Timeseries

10.5.5 Schedule answered message

The schedule answers messages are sent by Elia and received by the BSP.

All Schedule submitted messages are answered by Elia with a schedule answered message.

Note: no acknowledgement of an answer is supported

10.5.5.1 Message granularity

One Schedule answer will be sent for each schedule submitted message sent by the BSP.

10.5.5.2 Message timeframe

The confirmation message will be sent as soon as the schedule submitted message has been processed.

10.5.5.3 Message description

As described in the definition of answer message (see [Acknowledgement and answer messages](#)).

Field Code Changed

10.6 Reception of mFRR activation request

10.6.1 Description

Elia will send an asynchronous mFRR activation request message to the BSP.

BSP will generate one acknowledgement and two confirmation messages:

- Acknowledgement indicates the good reception of the activation request message
- First confirmation and second confirmation contain details about the activation performed following the activation request

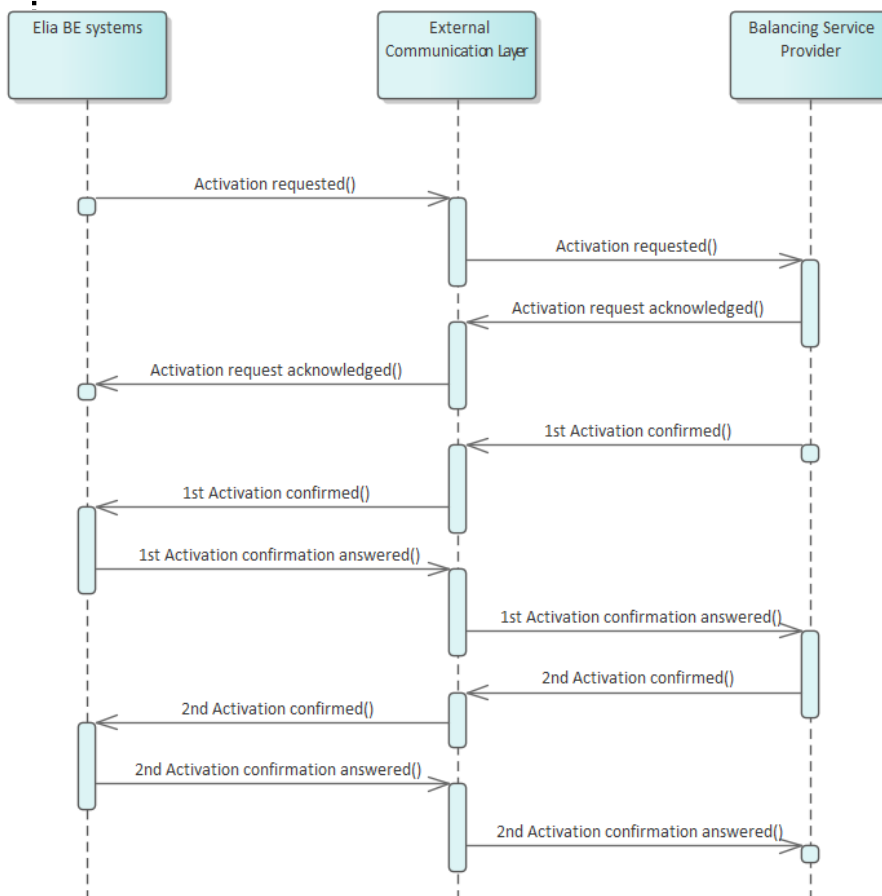

All communications in this flow are done asynchronously.

10.6.2 Queue information

This table contains the queues and exchanges to send and receive messages in a normal scenario:

Message Type	Description	Sender	Receiver	Queue/Exchange
mFRR Activation Requested	Activation request	Elia	BSP	mFRRActivationRequested.[TargetMarketPartyID].OutQ
mFRR Activation Request Acknowledged	Reception confirmation of an activation request message	BSP	Elia	mFRRActivationAcknowledged.In.Exch
mFRR Activation Confirmed	Answer to an activation request message	BSP	Elia	mFRRActivationConfirmed.In.Exch
mFRR Activation Confirmation Answered	Answer to a confirmation of activation request message	Elia	BSP	mFRRActivationConfirmationAnswered.[TargetMarketPartyID].OutQ

Error queues

This table contains the queues and exchanges to send and receive message only in case of error:

Message Type	Sender	Receiver	Queue/Exchange
mFRR Activation Requested	BSP	Elia	mFRRActivationRequested.Error.Exch
mFRR Activation Request Acknowledged	Elia	BSP	mFRRActivationAcknowledged.[TargetMarketPartyID].ErrorQ
mFRR Activation Confirmed	Elia	BSP	mFRRActivationConfirmed.[TargetMarketPartyID].ErrorQ
mFRR Activation Confirmation Answered	BSP	Elia	mFRRActivationConfirmationAnswered.Error.Exch

Formatted: English (United States)

10.6.3 Activation requested message

10.6.3.1 Message granularity

An mFRR activation request message groups all selected mFRR Energy Bids from a respective BSP covering 1 or multiple quarter hours (Eg. For a Direct Activation).

10.6.3.2 Message timeframe

The mFRR activation request message can be sent at any time, but will respect the FAT and will indicate whether it is a Scheduled Activation or a Direct Activation.

For a Scheduled Activation request, the start and end time communicated in the activation request message will be respectively the beginning of the quarter hour of activation and the end of the quarter hour of activation (for an mFRR Scheduled Activation request sent in the context of Network Element Constraint (redispatching), the end time will be the end of the last quarter hour of the activation).

For a Direct Activation request, the start and end time communicated in the activation request message will be respectively 7,5 minutes after the reception of the activation request by the BSP and the end of the second quarter hour of activation (for an mFRR Direct Activation request sent in the context of Network Element Constraint (redispatching) the end time will be the end of the last quarter hour of the activation).

10.6.3.3 Message description

A [Activation_MarketDocument](#) is the message that must be used in order to submit the activation requests.

Field Code Changed

Optional fields of the market document that are not described in this chapter cannot be used.

Activation_MarketDocument (Exactly one element per message)		
Field	Mandatory	Description
mRID	Y	Unique identifier for the market document
revisionNumber	Y	Version number for the market document.
Type	Y	Code for type of market document. Z15 = mFRR Activation Document
process.processType	Y	Code for type of process. A60 = "Scheduled activation" A61 = "Direct activation" Field will be empty for business type Z11 = Prequalification and B83 = Testing
sender_MarketParticipant.mRID	Y	The identification of the sender (EIC code) 10X1001A1001A094 = Elia
sender_MarketParticipant.marketRole.type	Y	The role code associated with receiver. Fixed value: A04 = System Operator
receiver_MarketParticipant.mRID	Y	The identification of the receiver (EIC code)
receiver_MarketParticipant.marketRole.type	Y	The role code associated with the receiver: A46 = Balancing Service Provider
createdDateTime	Y	The timestamp on which the message was sent
activation_Time_Period.timeInterval	Y	This information provides the start and end date and time of the activation time interval
TimeSeries	Y	Timeseries associated to the market document. It must contain at least one element.

TimeSeries		
Field	Mandatory	Description
mRID	Y	Bid Group Id of the activated mFRR Energy Bid.
businessType	Y	Identifies the reason why an activation is requested. Z11 = Prequalification A97 = Balancing. Manual Frequency restoration reserve B40 = Network element constraint B83 = Testing (code for Availability testing)

measurement_Unit.name	Y	MAW (Megawatt)
flowDirection.direction	Y	The coded identification of the direction of energy flow. A01 = UP A02 = DOWN
Period	Y	This list can only contain 1 element

Period		
Field	Mandatory	Description
timeInterval	Y	The start and end date and time of the activation
Resolution	Y	Amount of time for each interval in which a data value is defined. PT15M = 15 minutes
Point	Y	List of points associated to the period. It should contain as many point as needed to complete the period.

Point		
Field	Mandatory	Description
Position	Y	The interval number defining which position in the timeseries is indicated. It must start at 1.
Quantity	Y	Power requested. The principal quantity identified for a point. We require an accuracy of 1 MW.

timeInterval		
Field	Mandatory	Description
start	Y	The start date and time of the interval
end	Y	The end date and time of the interval

10.6.4 Activation acknowledged message

10.6.4.1 Message granularity

One activation acknowledgement must be sent for each activation request submitted by Elia.

10.6.4.2 Message timeframe

This acknowledgement must be sent immediately after the reception of the activation request message.

10.6.4.3 Message description

As described in the definition of acknowledgement message (see [Acknowledgement and answer messages](#)).

Field Code Changed

10.6.5 Activation confirmed message

For an mFRR activation, the Balancing Service Provider must respond to the activation request by

sending Elia two confirmation messages.

The confirmation messages must be sent after the acknowledgement message.

A confirmation message includes the list of delivery points that will be used to deliver the requested energy as well as the expected contribution per delivery point.

10.6.5.1 Message granularity

A confirmation message is sent for each activation request received. Multiple confirmations cannot be grouped in a same message.

10.6.5.2 Message timeframe

1st activation confirmation message is sent by the the Balancing Service Provider for the entire activation at once, at latest 5 minutes after the reception of the activation request.

2nd activation confirmation message is sent by the the Balancing Service Provider for the entire activation at once, at latest 8 minutes after the end of the last quarter hour of the activation.

10.6.5.3 Message description

A document [ActivationConfirmation_MarketDocument](#) is used for this message.

Optional fields of the market document that are not described in this chapter cannot be used.

ActivationConfirmation_MarketDocument (Exactly one element per message)		
Field	Mandatory	Description
mRID	Y	Unique identifier for the market document
revisionNumber	Y	Version number for the MarketDocument
type	Y	Code for type of market document. Z07 = 1 st confirmation Z08 = 2 nd confirmation
sender_MarketParticipant.mRID	Y	The identification number of the sender (EIC code).
Sender_MarketParticipant.marketRole.type	Y	The role code associated with the sender A46 = Balancing Service Provider
receiver_MarketParticipant.mRID	Y	The identification of the receiver (EIC code). 10X1001A1001A094 = Elia
receiver_MarketParticipant.marketRole.type	Y	The role code associated with the receiver A04 = System operator
createdDateTime	Y	The timestamp on which the message was sent
confirmed_MarketDocument.mRID	Y	The market document identification to which is replied
confirmed_MarketDocument.revisionNumber	Y	The market document revision number to which is replied
activation_Time_Period.timeInterval	Y	The start and end date and time of the activation to which all confirmed timeseries refers to
Confirmed_TimeSeries	Y	The timeseries replied to

Confirmed_TimeSeries		
Field	Mandatory	Description
mRID	Y	Bid Group Id
Period	Y	Periods associated to the timeseries.

		This list can only contain 1 element
--	--	--------------------------------------

Period		
Field	Mandatory	Description
timeInterval	Y	The start and end date and time of the activation for the timeseries
resolution	Y	PT15M = 15 minutes
Point	Y	List of points associated to the period. It should contain as many points as needed to complete the period.

Point		
Field	Mandatory	Description
position	Y	The interval number defining which position in the timeseries is indicated
quantity	Y	The principal quantity identified for a point. We require an accuracy of 1 MW.
RegisteredResource	Y	List of registered resources associated to this point. It contains the delivery points used for the activation, with their contribution

RegisteredResource		
Field	Mandatory	Description
mRID	Y	EAN code of a delivery point
quantity	Y	Expected contribution per delivery point. The principal quantity identified for a point. We require an accuracy of 0.1 MW.

timeInterval		
Field	Mandatory	Description
start	Y	Start time of the interval
end	Y	End time of the interval

10.6.6 Validation of an activation confirmed message

This information flow will be subject to all generic validation rules. These and the validation rules listed in the table below are further described in the following section of this document: [Validation rules description](#).

ID	Validation Rule	Reply Status	Reason Code	Level
ACT_001	Confirmation deadline not respected	Accept with warning	A57	MarketDocument
ACT_002	TimeSeries not matching	Accept with warning	A09	MarketDocument
ACT_003	Resolution inconsistency	Accept with warning	A41	Timeseries

Field Code Changed

ACT_004	Quantity inconsistency	Accept with warning	A42	MarketDocument
ACT_005	Quantity increased	Accept with warning	A43	MarketDocument
ACT_006	Quantity decreased	Accept with warning	A44	MarketDocument
ACT_007	Resource Object invalid	Accept with warning	A64	Timeseries

The first valid 1st Activation Confirmed message and 2nd Activation Confirmed message will be kept as truth by the systems. This means that if two 1st Activation Confirmed message are sent by the BSP (one via the ECL and one via the back-up via e-mail for example), only the first document received will be accepted by the systems and the following one will be rejected.

10.6.7 Activation confirmation answered message

10.6.7.1 Message granularity

An activation confirmation answered message is sent for each activation confirmed message received. Multiple validations cannot be grouped in a same message.

10.6.7.2 Message timeframe

An activation confirmation answered message is sent as soon as the activation confirmed message is processed by Elia.

10.6.7.3 Message description

As described in the definition of answer message (see [Acknowledgement and answer messages](#)).

Field Code Changed

10.6.8 Back-up Activation requested message

As mentioned in chapter 3.3, a back-up communication channel is put in place for the sending of activation request messages.

If Elia does not receive an activation acknowledged message within a reasonable timeframe after the sending of the activation requested message, Elia will automatically trigger the back-up process.

10.6.8.1 Activation requested message

The mFRR activation requested message will be sent via e-mail to the contractual 24/7 email address provided by the BSP.

Title of the message: Elia - Activation Request - mFRR – Start Date and Time – End Date and Time

Example: Elia - Activation Request - mFRR - 05/10/2023 12:45 - 05/10/2023 13:00

Body of the message:

Hello – ELIA has not received a technical acknowledgement after an activation was requested.

This message serves as a back-up communication for the below mFRR activation:

BidGroupld	Start time	DP

Bid group ID of the activated Bid	Requested volume in MW	List of DP EAN included in the Energy bid
-----------------------------------	------------------------	---

Example:

<i>BidGroupId</i>	<i>12:45</i>	<i>DP</i>
<i>MAT-3 Test_mFRR00_Up</i>	<i>25,0</i>	<i>541453137445795650;541453127036684861</i>

Attachement:

The mFRR activation requested message described in Chapter 10.6.3 initially sent to the BSP (JSON) will be included as attachement to the email.

10.6.8.2 Activation acknowledged message

Activation acknowledged message will be accepted via e-mail but are not compulsory for the good execution of the process. Such message has to be sent to activation@elia.be (ActivationDEMO@Elia.be for the DEMO environment).

The validation rules applied to the Activation acknowledged message will be similarly applied to the Activation acknowledged message sent via email.

Title of the message: BSP Name – Activation acknowledged message - mFRR – Start Date and Time – End Date and Time

Example: BSP1 - Activation acknowledged message - mFRR - 05/10/2023 12:45 - 05/10/2023 13:00

Body of the message:

Nothing is expected in the body of the message. Any content added in the body of the message will be accepted but disregarded by Elia.

Attachement:

The Activation acknowledged message described in Chapter 10.6.4 that should have been sent via ECL by the BSP (JSON) has to be included as attachement to the email.

10.6.8.3 Activation confirmed message

The two Activation confirmed messages have to be sent via e-mail (two different e-mails are expected, one for the first and one for the second activation confirmed messages) and are mandatory for the good execution of the process. Such messages have to be sent to activation@elia.be (ActivationDEMO@Elia.be for the DEMO environment).

Field Code Changed

Field Code Changed

Title of the message:

First activation confirmed message : BSP Name – FirstBusinessAck - mFRR – Start Date and Time – End Date and Time

Second activation confirmed message : BSP Name – SecondBusinessAck - mFRR – Start Date and Time – End Date and Time

Example: BSP1 - FirstBusinessAck - mFRR - 05/10/2023 12:45 - 05/10/2023 13:00

Body of the message:

Nothing is expected in the body of the message. Any content added In the body of the message will be disregarded by Elia.

Attachement:

The two Activation confirmed messages described in Chapter 10.6.5 [10.6.4](#) that should have been sent via ECL by the BSP (JSON) have to be included respectively as attachement to each email.

10.6.8.4 Validation of an activation confirmed message

The validation rules described in Chapter 10.6.6 applied to the Activation confirmed messages will be similarly applied to the Activation confirmed messages sent via email.

10.6.8.5 Activation confirmation answered message

Each of the Activation confirmed message will receive an answer from Elia.

Title of the message:

First activation confirmed message : Elia - AckOnFirstBusinessAck - mFRR - Start Date and Time – End Date and Time

Second activation confirmed message : Elia - AckOnSecondBusinessAck - mFRR – Start Date and Time – End Date and Time

Body of the message:

Hello – we did receive a BusinessAck1 or BusinessAck2 by email, therefore, Elia send back the ack by mail:

confirmed_MarketDocument.mRID	code	Text
309d975a8b4d4a6981e85b36fbba1a00	A01	Message fully accepted

Attachement:

The mFRR activation confirmation answered message described in Chapter [Q](#) that should have been sent to the BSP (JSON) will be included as attachement to the email.

Deleted: 10.6.7

10.7 Reception of mFRR communication test request

10.7.1 Description

Elia sends an asynchronous mFRR communication test request message to the BSP.

The communication test is meant to test the communication between Elia and the BSP. Therefore, the communication test will go through the same communication layers as for an Activation.

A communication test should be seen as an Activation with a specific BidGroupId labelled "CommunicationTest" and a specific DP ean labelled "99999999999999999999".

BSP will generate one acknowledgement and two confirmation messages:

- Acknowledgement indicates the good reception of the communication test request message;
- First confirmation and second confirmation contain details about the communication test performed following the activation request.

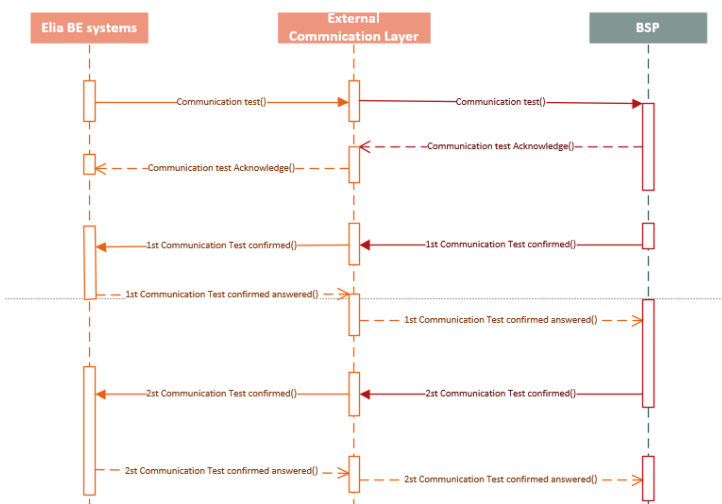

All communications in this flow are done asynchronously.

10.7.2 Queue information

This table contains the queues and exchanges to send and receive messages in a normal scenario:

Message Type	Description	Sender	Receiver	Queue/Exchange
--------------	-------------	--------	----------	----------------

mFRR Activation Requested	Activation request	Elia	BSP	mFRRActivationRequested.[TargetMarketPartyID].OutQ
mFRR Activation Request Acknowledged	Reception confirmation of an activation request message	BSP	Elia	mFRRActivationAcknowledged.In.Exch
mFRR Activation Confirmed	Answer to an activation request message	BSP	Elia	mFRRActivationConfirmed.In.Exch
mFRR Activation Confirmation Answered	Answer to a confirmation of activation request message	Elia	BSP	mFRRActivationConfirmationAnswered.[TargetMarketPartyID].OutQ

Error queues

This table contains the queues and exchanges to send and receive message only in case of error:

Message Type	Sender	Receiver	Queue/Exchange
mFRR Activation Requested	BSP	Elia	mFRRActivationRequested.Error.Exch
mFRR Activation Request Acknowledged	Elia	BSP	mFRRActivationAcknowledged.[TargetMarketPartyID].ErrorQ
mFRR Activation Confirmed	Elia	BSP	mFRRActivationConfirmed.[TargetMarketPartyID].ErrorQ
mFRR Activation Confirmation Answered	BSP	Elia	mFRRActivationConfirmationAnswered.Error.Exch

10.7.3 Communication test requested message

10.7.3.1 Message granularity

An mFRR communication test request message groups all selected mFRR Energy Bids from a respective BSP covering 1 or multiple quarter hours (Eg. For a Direct Communication test).

10.7.3.2 Message timeframe

The mFRR communication test request message can be sent at any time by ELIA and will indicate whether it is a Scheduled communication Test or a Direct Communication Test.

For a Scheduled Communication Test request, the start and end time communicated in the Communication Test request message will be respectively the beginning of the quarter hour of Communication Test and the end of the quarter hour of Communication Test (for an mFRR Scheduled Communication Test request sent in the context of Network Element Constraint (redispatching) the end time will be the end of the last quarter hour of the Communication Test).

For a Direct Communication Test request, the start and end time communicated in the Communication Test request message will be respectively 7,5 minutes after the reception of the Communication Test request and the end of the second quarter hour of Communication Test (for an mFRR Direct Communication Test request sent in the context of Network Element Constraint (redispatching) the end time will be the end of the last quarter hour of the Communication Test).

10.7.3.3 Message description

An [Activation_MarketDocument](#) is the message that must be used in order to submit the Communication Test requests.

Field Code Changed

Optional fields of the market document that are not described in this chapter cannot be used.

Activation_MarketDocument (Exactly one element per message)		
Field	Mandatory	Description
mRID	Y	Unique identifier for the market document
revisionNumber	Y	Version number for the market document.
Type	Y	Code for type of market document. Z15= mFRR Activation Document
process.processType	Y	Code for type of process. A60 = "Scheduled activation" A61 = "Direct activation" Field will be empty for business type Z11 = Prequalification and B83 = Testing
sender_MarketParticipant.mRID	Y	The identification of the sender (EIC code) 10X1001A1001A094 = Elia
sender_MarketParticipant.marketRole.type	Y	The role code associated with receiver. Fixed value: A04 = System Operator
receiver_MarketParticipant.mRID	Y	The identification of the receiver (EIC code)
receiver_MarketParticipant.marketRole.type	Y	The role code associated with the receiver: A46 = Balancing Service Provider
createdDateTime	Y	The timestamp on which the message was sent
activation_Time_Period.timeInterval	Y	This information provides the start and end date and time of the activation time interval
TimeSeries	Y	Timeseries associated to the market document. It must contain at least one element.

TimeSeries		
Field	Mandatory	Description
mRID	Y	Bid Group Id of the activated mFRR Energy Bid. CommunicationTest = Communication Test mRID
businessType	Y	Identifies the reason why an activation is requested. Z11 = Prequalification A97 = Balancing. Manual Frequency restoration reserve B40 = Network element constraint

		B83 = Testing (code for Availability testing)
measurement_Unit.name	Y	MAW (Megawatt)
flowDirection.direction	Y	The coded identification of the direction of energy flow. A01 = UP A02 = DOWN
Period	Y	This list can only contain 1 element

Period		
Field	Mandatory	Description
timeInterval	Y	The start and end date and time of the activation
resolution	Y	Amount of time for each interval in which a data value is defined. PT15M = 15 minutes
Point	Y	List of points associated to the period. It should contain as many point as needed to complete the period.

Point		
Field	Mandatory	Description
position	Y	The interval number defining which position in the timeseries is indicated. It must start at 1.
Quantity	Y	Power requested. The principal quantity identified for a point. We require an accuracy of 1 MW.

timeInterval		
Field	Mandatory	Description
start	Y	The start date and time of the interval
end	Y	The end date and time of the interval

10.7.4 Communication Test acknowledged message

10.7.4.1 Message granularity

One Communication test acknowledgement must be sent for each Communication test request submitted by Elia.

10.7.4.2 Message timeframe

This acknowledgement must be sent immediately after the reception of the Communication test request message.

10.7.4.3 Message description

As described in the definition of acknowledgement message (see [Acknowledgement and answer messages](#)).

Field Code Changed

10.7.5 Communication test confirmed message

For an mFRR Communication test, the Balancing Service Provider must respond to the Communication test request by sending Elia two confirmation messages.

The confirmation messages must be sent after the acknowledgement message.

A confirmation message includes the list of delivery points used to deliver the requested energy as well as the contribution per delivery point.

10.7.5.1 Message granularity

Two confirmation messages are sent to Elia for each activation request received by the BSP. Multiple confirmations cannot be grouped in a same message.

10.7.5.2 Message timeframe

1st Communication test confirmation message is sent by the the Balancing Service Provider for the entire Communication test at once, at latest 5 minutes after the reception of the Communication test request.

2nd Communication test confirmation message is sent by the the Balancing Service Provider for the entire Communication test at once, at latest 8 minutes after the end of the last quarter hour of the Communication test.

10.7.5.3 Message description

A document [ActivationConfirmation_MarketDocument](#) is used for this message.

Optional fields of the market document that are not described in this chapter cannot be used.

ActivationConfirmation_MarketDocument (Exactly one element per message)		
Field	Mandatory	Description
mRID	Y	Unique identifier for the market document
revisionNumber	Y	Version number for the MarketDocument
type	Y	Code for type of market document. Z07 = 1 st confirmation Z08 = 2 nd confirmation
sender_MarketParticipant.mRID	Y	The identification number of the sender (EIC code).
Sender_MarketParticipant.marketRole.type	Y	The role code associated with the sender A46 = Balancing Service Provider
receiver_MarketParticipant.mRID	Y	The identification of the receiver (EIC code). 10X1001A1001A094 = Elia
receiver_MarketParticipant.marketRole.type	Y	The role code associated with the receiver A04 = System operator
createdDateTime	Y	The timestamp on which the message was sent
confirmed_MarketDocument.mRID	Y	The market document identification to which is replied
confirmed_MarketDocument.revisionNumber	Y	The market document revision number to which is replied
activation_Time_Period.timeInterval	Y	The start and end date and time of the activation to which all confirmed timeseries refers to
Confirmed_TimeSeries	Y	The timeseries replied to

Confirmed_TimeSeries		
Field	Mandatory	Description
mRID	Y	ID for the communication test CommunicationTest = Communication Test mRID
Period	Y	Period associated to the timeseries. This list can only contain 1 element

Period		
Field	Mandatory	Description
timeInterval	Y	The start and end date and time of the activation for the timeseries
resolution	Y	PT15M = 15 minutes
Point	Y	List of points associated to the period. It should contain as many points as needed to complete the period.

Point		
Field	Mandatory	Description
position	Y	The interval number defining which position in the timeseries is indicated
quantity	Y	The principal quantity identified for a point. We require an accuracy of 1 MW.
RegisteredResource	Y	List of registered resources associated to this point. It contains the delivery points used for the activation with their contribution

RegisteredResource		
Field	Mandatory	Description
mRID	Y	EAN code of a delivery point 999999999999999999999999 = Default Delivery point EAN
quantity	Y	Expected contribution per delivery point. The principal quantity identified for a point. We require an accuracy of 1 MW.

timeInterval		
Field	Mandatory	Description
start	Y	Start time of the interval
end	Y	End time of the interval

10.7.6 Validation of a Communication Test confirmed message

This information flow will be subject to all generic validation rules. These and the validation rules listed in the table below are further described in the following section of this document: [Validation rules description](#).

Field Code Changed

ID	Validation Rule	Reply Status	Reason Code	Level
ACT_001	Confirmation deadline not respected	Accept with warning	A57	MarketDocument
ACT_002	TimeSeries not matching	Accept with warning	A09	MarketDocument
ACT_003	Resolution inconsistency	Accept with warning	A41	Timeseries
ACT_004	Quantity inconsistency	Accept with warning	A42	MarketDocument
ACT_005	Quantity increased	Accept with warning	A43	MarketDocument
ACT_006	Quantity decreased	Accept with warning	A44	MarketDocument
ACT_007	Resource Object invalid	Accept with warning	A64	Timeseries

10.7.7 Communication Test confirmation answered message

10.7.7.1 Message granularity

A Communication Test confirmation answered message is sent by ELIA for each Communication Test confirmed message received. Multiple validations cannot be grouped in a same message.

10.7.7.2 Message timeframe

A Communication Test confirmation answered message is sent by Elia as soon as the Communication Test confirmed message is processed.

10.7.7.3 Message description

As described in the definition of answer message (see [Acknowledgement and answer messages](#)).

Field Code Changed

10.8 Submitting aFRR Energy Bids

10.8.1 Description

This information flow describes the process of submitting bids to the External Communication Layer.

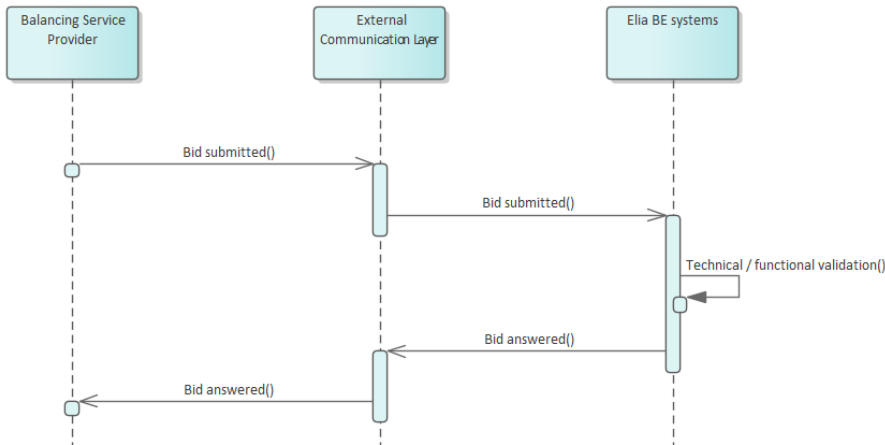

The Balancing Service Provider will send a bid message asynchronously to Elia. The External Communication Layer will treat the message in an asynchronous manner and will reply to it with the result of the validation done in the Elia backend systems.

10.8.2 Queue information

This table contains the queues and exchanges to send and receive messages in a normal scenario:

Message Type	Description	Sender	Receiver	Queue/Exchange
aFRR Bid Submitted	Submission of new bid or bid update	BSP	Elia	aFRREnergyBidSubmitted.In.Exch
aFRR Bid Answered	Answer to a bid message	Elia	BSP	aFRREnergyBidAnswered.[TargetMarketPartyID].OutQ

Error queues

This table contains the queues and exchanges to send and receive message only in case of error:

Message Type	Sender	Receiver	Queue/Exchange
aFRR Bid Submitted	Elia	BSP	aFRREnergyBidSubmitted.[TargetMarketPartyID].ErrorQ
aFRR Bid Answered	BSP	Elia	aFRREnergyBidAnswered.Error.Exch

10.8.3 Bid submitted message

10.8.3.1 Message granularity

For bidding, the granularity is set at the **Providing Group** and the **bid execution date** level. Meaning that for each combination of these objects, we expect exactly one single message per sent version.

10.8.3.2 Message timeframe

aFRR bids can be submitted between D-7 and BE GCT. Updates are allowed after BE GCT for certain reasons that have to be indicated in the message.

For timings on obligation of submission of contracted volumes please refer to the contract.



10.8.3.3 Message description

A [ReserveBid_MarketDocument](#) is the message that must be used in order to submit the bids.

Field Code Changed

Optional fields of the market document that are not described in this chapter cannot be used.

ReserveBid_MarketDocument (exactly one element per message)		
Field	Mandatory	Description
mRID	Y	Unique identification of the market document (UUID)
revisionNumber	Y	Version number for the market document
type	Y	Type of market document. Fixed value: A24 = Bid Document
process.processType	Y	Code for type of process: A51 = Automatic frequency restoration reserve
sender_MarketParticipant.mRID	Y	The identification of the sender (EIC code)
sender_MarketParticipant.marketRole.type	Y	The role code associated with the sender: A46 = Balancing Service Provider
receiver_MarketParticipant.mRID	Y	The identification of the receiver (EIC code). Fixed value: 10X1001A1001A094 = Elia
receiver_MarketParticipant.marketRole.type	Y	The role code associated with the receiver: A04 = System Operator
createdDateTime	Y	The date and time of the creation of the document
reserveBid_Period.timeInterval	Y	The beginning and ending date and time of the period covered by the document
Bid_TimeSeries	Y	Bid timeseries associated to the market document. It must contain at least one element.

Bid_TimeSeries		
Field	Mandatory	Description
mRID	Y	Unique identification of the bid timeseries within the market document
status	N	Only used in case of cancellation, with the following code: A09 = Cancelled
auction.mRID	Y	Possible values :

		Z01 = Non-contracted Z02 = Contracted
businessType	Y	Identifies the trading nature of the timeseries: B74 = Offer
bidGroupId	Y	The Bid Group Id is used to link the upward and downward volume for a Providing Group
ProvidingGroup	Y	The Delivery Points that form the Providing Group to which these bids are related. The list should contain at least one element.
BidGroup	N	The specific Delivery Points to which the Bid Group is related.
flowDirection.direction	Y	The coded identification of the direction of energy flow. A01 = UP A02 = DOWN
Period	Y	List of periods associated to the timeseries. It should contain at least one element.

Period		
Field	Mandatory	Description
timeInterval	Y	The start and end date and time of the period
resolution	Y	PT15M = 15 minutes
Point	Y	List of points associated to the period. It should contain as many point as needed to complete the period.

Point		
Field	Mandatory	Description
position	Y	The interval number defining which position in the timeseries is indicated. It must start at 1.
Quantity.quantity	Y	The maximum Bid Volume offered in the bid
energy_Price.amount	Y	Price in euro for each offered MWh
PointGroup	N	The specific Delivery Points to which the interval of this bid is related.
Reason	N	List of reasons associated to the point. Maximum one element.

RegisteredResource		
Field	Mandatory	Description
mRID	Y	EAN code of a DeliveryPoint

Reason		
Field	Mandatory	Description
code	Y	Y24 = Forced Outage The concerned contracted or non-contracted aFRR Energy Bid is impacted by a Forced Outage. B46 = Internal Congestion (DP activated for redispatching)

		<p>A Redispatching Energy Bid, provided by a Delivery Point Dpsu also included in the concerned non-contracted aFRR Energy Bid, is activated by ELIA.</p> <p>Y25 = Other The concerned non-contracted aFRR Energy Bid contains (a) Delivery Point(s) that is (are) operated to balance the perimeter of the concerned BRP (i.e. for self-balancing), to balance the ELIA LFC Block (i.e. for reactive balancing) or to perform a trade on the intraday market.</p>
--	--	---

timeInterval		
Field	Mandatory	Description
start	Y	The start date and time of the interval
end	Y	The end date and time of the interval

10.8.4 Validation of a bid submitted message

This information flow will be subject to all generic validation rules. These and the validation rules listed in the table below are further described in the following section of this document: [Validation rules description](#).

Field Code Changed

All threshold values used in the validation rules are subject to change and will be defined in the contract.

10.8.4.1 Validations on bid structure and time

ID	Validation Rule	Reply Status	Reason Code	Level
BID_001	The time period of the message must exactly cover one day	Reject message	Y86	MarketDocument
BID_002	All timeseries within the same message must have the same Providing Group	Reject message	Y84	MarketDocument
BID_003	The bid timeseries period interval must be a multiple of the resolution (default 15 min)	Reject message	A41	Timeseries
BID_025	No overlap of periods allowed for timeseries of the same Bid Group and for the same direction	Reject message	Y83	Timeseries
BID_005	The same MarketDocument mRID must be used per Providing Group, per MarketDocument time interval	Reject message	Y82	MarketDocument
BID_065	It is not allowed to change the cancellation status for timeseries that have bids in the past	Reject message	Y14	Timeseries
BID_066	It is not allowed to list a Delivery Point on Energy Bids for the same quarter hour in different Providing Groups	Reject message	Y79	Timeseries

10.8.4.2 Validations on Delivery Point

ID	Validation Rule	Reply Status	Reason Code	Level
BID_009	The Delivery Points of the Bid Group must belong to the Providing Group, if the Bid Group is defined	Reject message	Y78	Timeseries

BID_010	The Delivery Points in a specific quarter hour bid must belong to the Providing Group	Reject message	Y77	Timeseries
BID_011	The BSP must have a valid BSP aFRR contract and all Delivery Points must be included in the pool of the BSP %EAN%	Reject message	Y76	MarketDocument
BID_012	If a DP _{SU} Delivery Point is included in the Providing Group, then all other Delivery Points from that Providing Group must belong to the same Technical Facility	Reject message	Y75	MarketDocument
BID_013	A DP _{PG} Delivery Point cannot be listed in an mFRR bid or as an mFRR backup Delivery Point for the same quarter hour on the same execution date	Reject message	Y57	Timeseries
BID_014	A Delivery Point cannot be listed as a Prequalification Bid for the same execution date	Reject message	Y56	MarketDocument
BID_059	The Delivery Points in a specific quarter hour bid must belong to the Bid Group, if the Bid Group is defined	Reject message	Y21	Timeseries

10.8.4.3 Validations on Bid Volume

ID	Validation Rule	Reply Status	Reason Code	Level
BID_016	The Bid Volume must be greater than or equal to zero	Reject message	Y73	Timeseries
BID_017	For bids submitted before Gate Closure Time the Bid Volume must be greater than or equal to 1 MW	Reject message	Y72	Timeseries
BID_018	Bid Volume granularity is equal to 1 MW	Reject message	Y71	Timeseries
BID_023	The Bid Volume must be smaller than or equal to the sum of the values of DP _{aFRR,max}	Reject message	Y69	Timeseries
BID_024	Per Providing Group composed of DP _{pg} , the Bid Volume must be smaller than or equal to 50 MW	Reject message	Y54	MarketDocument

10.8.4.4 Validations on Bid Price

ID	Validation Rule	Reply Status	Reason Code	Level
BID_026	Bid Price granularity is equal to 0,01 €/MWh	Reject message	Y68	Timeseries
BID_027	The Bid Price must be greater than or equal to a minimum threshold price and must be smaller than or equal to a maximum threshold price	Reject message	B51	Timeseries
BID_028	A warning will be given if the Bid Price falls out of a threshold range determined by Elia	Accepted with warning	Y67	Timeseries

10.8.4.5 Validation on bid linking

ID	Validation Rule	Reply Status	Reason Code	Level
BID_040	No technical linking is allowed across Providing Groups	Reject message	Y41	Timeseries

10.8.4.6 Validations on timelines

ID	Validation Rule	Reply Status	Reason Code	Level
BID_042	No new bids can be submitted after Gate Closure Time	Reject message	Y47	Timeseries
BID_043	If bids are updated after BE GCT it is only allowed to reduce the Bid Volume. All other properties must remain unchanged.	Reject message	Y59	Timeseries
BID_045	If bids are updated after BE GCT a reason needs to be provided	Reject message	Y58	Timeseries
BID_047	If the Bid Volume is reduced after BE GCT, a warning will be provided to the BSP	Accepted with warning	Y46	Timeseries
BID_048	The execution date in the message must be greater than or equal to the current date and must be smaller than or equal to current date + 7 days	Reject message	Y60	MarketDocument
BID_058	Contracted energy bids updated after BE GCT are only allowed with a reason "Forced Outage"	Reject message	Y58	Timeseries
BID_061	No updates are allowed after 5 minutes before the validity period of the bid	Reject message	Y22	Timeseries

10.8.4.7 Validations linked to congestion

ID	Validation Rule	Reply Status	Reason Code	Level
BID_062	Increasing Bid Volume by submitting new or updated non contracted Energy Bids containing Delivery Points located in an electrical zone with a medium or high CRI level may be subject to filtering	Accepted with warning	Y19	Timeseries
BID_063	Increasing Bid Volume by submitting new or updated contracted Energy Bids containing Delivery Points located in an electrical zone with a medium or high CRI level is not allowed	Reject	Y16	Timeseries

10.8.5 Bid answered message

10.8.5.1 Message granularity

One answer will be sent by Elia for each bid submitted message submitted by the BSP.

10.8.5.2 Message timeframe

The confirmation message will be sent as soon as the bid message has been received and processed by Elia.

10.8.5.3 Message description

As described in the definition of answer message (see [Acknowledgement and answer messages](#)).

Field Code Changed

10.9 Submitting aFRR backup Delivery Points

10.9.1 Description

This message allows Market Parties to submit a list of backup Delivery Points for aFRR bids. The message contains a list of backup Delivery Points per quarter hour for an execution date. The list of backup Delivery Points is not linked to any specific bid, any Bid Group or any Providing Group.

This information flow describes the process of providing backup Delivery Points.

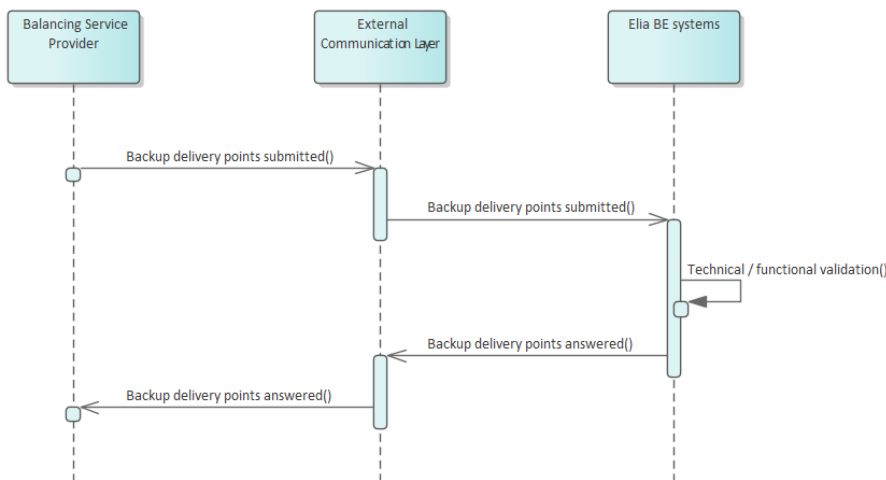

10.9.2 Queue information

This table contains the queues and exchanges to send and receive messages in a normal scenario:

Message Type	Description	Sender	Receiver	Queue/Exchange
aFRR Backup Delivery Points Submitted	Submission of new aFRR backup Delivery Points or backup Delivery Points update	BSP	Elia	aFRRBackupDeliveryPointSubmitted.In.Exch
aFRR Backup Delivery Points Answered	Answer to a aFRR backup Delivery Points message	Elia	BSP	aFRRBackupDeliveryPointAnswered.[TargetMarketPartyID].OutQ

Error queues

This table contains the queues and exchanges to send and receive message only in case of error:

Message Type	Sender	Receiver	Queue/Exchange
aFRR Backup Delivery Points Submitted	Elia	BSP	aFRRBackupDeliveryPointSubmitted.[TargetMarketPartyID].ErrorQ
aFRR Backup Delivery Points Answered	BSP	Elia	aFRRBackupDeliveryPointAnswered.Error.Exch

10.9.3 aFRR backup Delivery Points submitted message

10.9.3.1 Message granularity

The granularity of the backup Delivery Point message is set at execution date level. Meaning that a message is expected per execution date, containing a list of backup Delivery Points for that date.

10.9.3.2 Message timeframe

Backup Delivery Point messages can be submitted from gate opening time, which is D-7, until Gate Closure Time.

10.9.3.3 Message description

A document [BackupDeliveryPoints_MarketDocument](#) is used for the aFRR backup Delivery Points message.

Field Code Changed

BackupDeliveryPoints_MarketDocument (exactly one element per message)		
Field	Mandatory	Description
mRID	Y	Unique identification of the market document
revisionNumber	Y	Version number for the market document
type	Y	Type of market document. Fixed value: Z09 = Backup Delivery Points Document
process.processType	Y	Fixed value: A51 = Automatic frequency restoration reserve
sender_MarketParticipant.mRID	Y	The identification ID of the sender (EIC code)
sender_MarketParticipant.marketRole.type	Y	The role code associated with sender A46 = Balancing Service Provider
receiver_MarketParticipant.mRID	Y	The identification number of the receiver (EIC code). Fixed value: 10X1001A1001A094 = Elia
receiver_MarketParticipant.marketRole.type	Y	The role code associated with receiver. Fixed value: A04 = System Operator
createdDateTime	Y	The date and time of the creation of the document
backupDeliveryPoints_Period.timeInterval	Y	The beginning and ending date and time of the period covered by the document
BackupDeliveryPoints_TimeSeries	Y	BackupDeliveryPoints_TimeSeries contained in the message

BackupDeliveryPoints_TimeSeries		
Field	Mandatory	Description
mRID	Y	Unique identification of the BackupDeliveryPoints_TimeSeries within the market document
Period	Y	List of Period

Period		
Field	Mandatory	Description

timeInterval	Y	The start and end date and time of the period
resolution	Y	Amount of time for each interval in which a data value is defined. Fixed value: PT15M = 15 minutes
Point	Y	List of Point

Point		
Field	Mandatory	Description
position	Y	The interval number defining which position in the period is indicated
PointGroup	N	List of backup Delivery Points for the quarter hour. In order to cancel (all) backup Delivery Points, it is allowed to leave the PointGroup empty

RegisteredResource		
Field	Mandatory	Description
mRID	Y	EAN code of a DeliveryPoint

timeInterval		
Field	Mandatory	Description
start	Y	The start date and time of the interval
end	Y	The end date and time of the interval

10.9.4 Validation of a aFRR backup Delivery Points submitted message

This information flow will be subject to all generic validation rules. These and the validation rules listed in the table below are further described in the following section of this document: [Validation rules description](#).

Field Code Changed

All threshold values used in the validation rules are subject to change and will be defined in the contract.

ID	Validation Rule	Reply Status	Reason Code	Level
BACK_001	The time period of the message must exactly cover one day	Reject message	Y86	MarketDocument
BACK_002	The combination of MarketDocument mRID and the sender marketParty mRID must be unique per MarketDocument time interval	Reject message	Y44	MarketDocument
BACK_003	The BSP must have a valid BSP aFRR contract and all Delivery Points must be included in the pool of the BSP	Reject message	Y76	MarketDocument
BACK_005	The DP _{PG} backup Delivery Points cannot be listed in an mFRR bid or as an mFRR backup Delivery Point on the same quarter hour on the same execution date	Reject message	Y43	Timeseries
BACK_006	The backup Delivery Points cannot be listed in a Prequalification Bid on the same execution date	Reject message	Y43	Timeseries
BACK_007	Updates to backup Delivery Points after Gate Closure Time are not allowed	Reject message	Y12	Timeseries

10.9.5 aFRR backup Delivery Points answered message

10.9.5.1 Message granularity

One answer will be sent by Elia for each aFRR backup Delivery Points message submitted by the BSP.

10.9.5.2 Message timeframe

The confirmation message will be sent as soon as the aFRR backup Delivery Points message has been received and processed by Elia.

10.9.5.3 Message description

As described in the definition of answer message (see [Acknowledgement and answer messages](#)).

Field Code Changed

10.10 Reception of aFRR activation request

10.10.1 Description

For the activation of contracted aFRR energy bids for congestion management, Elia will send asynchronous aFRR activation requests messages to the BSP. If a Providing Group is mentioned in this section, the Balancing Providing Group is meant.

BSP will generate one acknowledgement and two confirmation messages:

- *Acknowledgement indicates the good reception of the activation request message*
- *First confirmation and second confirmation contain details about the activation performed following the activation request*

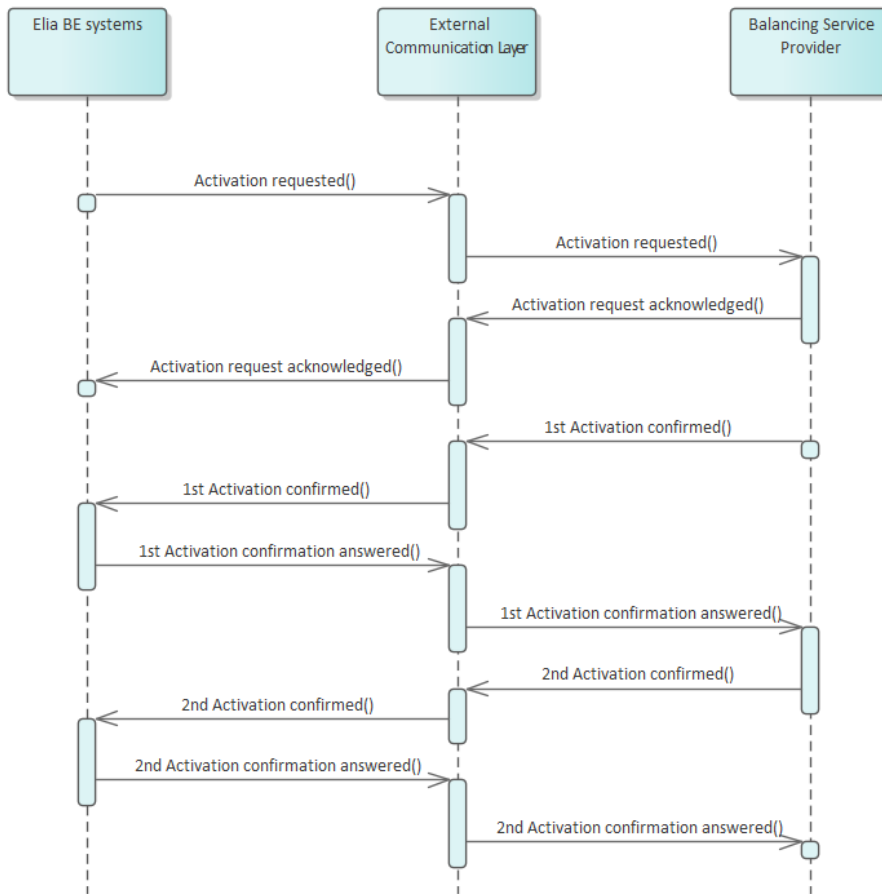

All communications in this flow are done asynchronously.

10.10.2 Queue information

This table contains the queues and exchanges to send and receive messages in a normal scenario:

Message Type	Description	Sender	Receiver	Queue/Exchange
aFRR Activation Requested	Activation request	Elia	BSP	aFRRActivationRequested.[TargetMarketPartyID].OutQ
aFRR Activation Request Acknowledged	Reception confirmation of an activation request message	BSP	Elia	aFRRActivationAcknowledged.In.Exch
aFRR	Confirmation of an	BSP	Elia	aFRRActivationConfirmed.In.Exch

Activation Confirmed	activation request			
aFRR Activation Confirmation Answered	Answer to a confirmation of activation request message	Elia	BSP	aFRRActivationConfirmationAnswered.[TargetMarketPartyID].OutQ

Error queues

This table contains the queues and exchanges to send and receive message only in case of error:

Message Type	Sender	Receiver	Queue/Exchange
aFRR Activation Requested	BSP	Elia	aFRRActivationRequested.Error.Exch
aFRR Activation Request Acknowledged	Elia	BSP	aFRRActivationAcknowledged.[TargetMarketPartyID].ErrorQ
aFRR Activation Confirmed	Elia	BSP	aFRRActivationConfirmed.[TargetMarketPartyID].ErrorQ
aFRR Activation Confirmation Answered	BSP	Elia	aFRRActivationConfirmationAnswered.Error.Exch

10.10.3 Activation requested message

10.10.3.1 Message granularity

An aFRR activation request message groups all selected aFRR Energy Bids from a respective BSP covering 1 or multiple quarter hours.

10.10.3.2 Message timeframe

The aFRR activation request message will be sent at the aFRR Balancing GCT of the first aFRR energy bid activated. The activation request will only be scheduled.

For a Scheduled Activation request, the start and end time communicated in the activation request message will be the beginning of the first quarter hour of activation and end of the last quarter hour of activation.

10.10.3.3 Message description

An [Activation MarketDocument](#) is the message that is used to request an aFRR activation.

Field Code Changed

Activation_MarketDocument (Exactly one element per message)		
Field	Mandatory	Description
mRID	Y	Unique identifier for the MarketDocument
revisionNumber	Y	Version number for the MarketDocument.
Type	Y	Code for type of MarketDocument. Z16 = aFRR Activation Document
process.processType	Y	Code for type of process. A60 = "Scheduled activation"
sender_MarketParticipant.mRID	Y	The identification of the sender (EIC code) 10X1001A1001A094 = Elia

sender_MarketParticipant.marketRole.type	Y	The role code associated with receiver. Fixed value: A04 = System Operator
receiver_MarketParticipant.mRID	Y	The identification of the receiver (EIC code)
receiver_MarketParticipant.marketRole.type	Y	The role code associated with the receiver: A46 = Balancing Service Provider
createdDateTime	Y	The timestamp on which the message was sent
activation_Time_Period.timeInterval	Y	This information provides the start and end date and time of the activation time interval
TimeSeries	Y	Timeseries associated to the market document. It must contain at least one element.

TimeSeries		
Field	Mandatory	Description
mRID	Y	Bid Group Id of the activated aFRR bid.
businessType	Y	Identifies the reason why an activation is requested. B40 = Network element constraint
measurement_Unit.name	Y	MAW (Megawatt)
flowDirection.direction	Y	The coded identification of the direction of energy flow. A01 = UP A02 = DOWN
Period	Y	This list can only contain 1 element

Period		
Field	Mandatory	Description
timeInterval	Y	The start and end date and time of the aFRR activation.
Resolution	Y	Amount of time for each interval in which a data value is defined. Fixed value: PT15M = 15 minutes
Point	Y	List of points associated to the period. It should contain as many point as needed to complete the period.

Point		
Field	Mandatory	Description
position	Y	The interval number defining which position in the timeseries is indicated. It must start at 1.
Quantity	Y	Power requested. The principal quantity identified for a point. We require an accuracy of 1 MW.

timeInterval		
Field	Mandatory	Description
start	Y	The start date and time of the interval
end	Y	The end date and time of the interval

10.10.4 Activation acknowledged message

10.10.4.1 Message granularity

One aFRR activation acknowledgement must be sent for each aFRR activation request submitted by Elia.

10.10.4.2 Message timeframe

This acknowledgement must be sent immediately after the reception of the aFRR activation request message.

10.10.4.3 Message description

As described in the definition of acknowledgement message (see [Acknowledgement and answer messages](#)).

Field Code Changed

10.10.5 Activation confirmed message

For an aFRR activation, the BSP must confirm the activation request by sending Elia two confirmation messages.

The confirmation messages must be sent after the acknowledgement message.

A confirmation message includes the list of delivery points that will be used to deliver the requested energy as well as the expected contribution per delivery point.

10.10.5.1 Message granularity

A confirmation message is sent for each activation request received. Multiple confirmations cannot be grouped in a same message.

10.10.5.2 Message timeframe

1st activation confirmation message is sent by the BSP for the entire activation at once, at latest 5 minutes after the reception of the activation request.

2nd activation confirmation is sent by the BSP for the entire activation at once, at latest 8 minutes after the end of the last quarter hour of the activation.

10.10.5.3 Message description

A document [ActivationConfirmation_MarketDocument](#) is used for this message.

Optional fields of the market document that are not described in this chapter cannot be used.

ActivationConfirmation_MarketDocument (Exactly one element per message)		
Field	Mandatory	Description
mRID	Y	Unique identifier for the market document
revisionNumber	Y	Version number for the MarketDocument
type	Y	Code for type of market document. Z07 = 1 st confirmation Z08 = 2 nd confirmation
sender_MarketParticipant.mRID	Y	The identification number of the sender (EIC code).

Sender_MarketParticipant.marketRole.type	Y	The role code associated with the sender A46 = Balancing Service Provider
receiver_MarketParticipant.mRID	Y	The identification of the receiver (EIC code). 10X1001A1001A094 = Elia
receiver_MarketParticipant.marketRole.type	Y	The role code associated with the receiver A04 = System operator
createdDateTime	Y	The timestamp on which the message was sent
confirmed_MarketDocument.mRID	Y	The market document identification to which is replied
confirmed_MarketDocument.revisionNumber	Y	The market document revision number to which is replied
activation_Time_Period.timeInterval	Y	The start and end date and time of the activation to which all confirmed timeseries refers to
Confirmed_TimeSeries	Y	The timeseries replied to

Confirmed_TimeSeries		
Field	Mandatory	Description
mRID	Y	Bid Group Id
Period	Y	Periods associated to the timeseries. This list can only contain 1 element

Period		
Field	Mandatory	Description
timeInterval	Y	The start and end date and time of the activation for the timeseries
resolution	Y	PT15M = 15 minutes
Point	Y	List of points associated to the period. It should contain as many points as needed to complete the period.

Point		
Field	Mandatory	Description
position	Y	The interval number defining which position in the timeseries is indicated
quantity	Y	The principal quantity identified for a point. We require an accuracy of 1 MW.
RegisteredResource	Y	List of registered resources associated to this point. It contains the delivery points used for the activation, with their contribution

RegisteredResource		
Field	Mandatory	Description
mRID	Y	EAN code of a delivery point
quantity	Y	Expected contribution per delivery point. The principal quantity identified for a point. We require an accuracy of 0.1 MW.

timeInterval		
Field	Mandatory	Description
start	Y	Start time of the interval
end	Y	End time of the interval

10.10.6 Validation of an activation confirmed message

This information flow will be subject to all generic validation rules. These and the validation rules listed in the table below are further described in the following section of this document: [Validation rules description](#).

Field Code Changed

ID	Validation Rule	Reply Status	Reason Code	Level
ACT_001	Confirmation deadline not respected	Accept with warning	A57	MarketDocument
ACT_002	TimeSeries not matching	Accept with warning	A09	MarketDocument
ACT_003	Resolution inconsistency	Accept with warning	A41	Timeseries
ACT_004	Quantity inconsistency	Accept with warning	A42	MarketDocument
ACT_005	Quantity increased	Accept with warning	A43	MarketDocument
ACT_006	Quantity decreased	Accept with warning	A44	MarketDocument
ACT_007	Resource Object invalid	Accept with warning	A64	Timeseries

The first valid 1st Activation Confirmed message and 2nd Activation Confirmed message will be kept as truth by the systems. This means that if two 1st Activation Confirmed message are sent by the BSP (one via the ECL and one via the back-up via e-mail for example), only the first document received will be accepted by the systems and the following one will be rejected.

10.10.7 Activation confirmation answered message

10.10.7.1 Message granularity

An activation confirmation answered message is sent for each activation confirmed message received. Multiple validations cannot be grouped in a same message.

10.10.7.2 Message timeframe

An activation confirmation answered message is sent as soon as the activation confirmed message is processed by Elia.

10.10.7.3 Message description

As described in the definition of answer message (see [Acknowledgement and answer messages](#)).

Field Code Changed

10.11 Reception of aFRR communication test request

10.11.1 Description

Elia will send asynchronous aFRR communication test requests messages to the BSP. If a Providing Group is mentioned in this section, the Balancing Providing Group is meant.

The communication test is meant to test the communication between Elia and the BSP. Therefore the communication test will go through the same communication layers as an Activation.

A Communication test should be seen as an Activation with a specific BidGroupId: "CommunicationTest" and a specific DP ean: "99999999999999999999".

BSP will generate one acknowledgement and two confirmation messages:

- Acknowledgement indicates the good reception of the communication test request message
- First confirmation and second confirmation contain details about the communication test performed following the communication test request

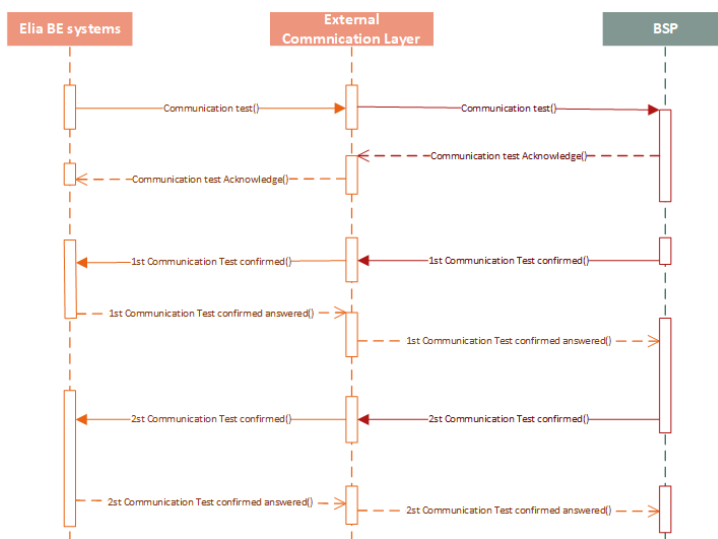

All communications in this flow are done asynchronously.

10.11.2 Queue information

This table contains the queues and exchanges to send and receive messages in a normal scenario:

Message Type	Description	Sender	Receiver	Queue/Exchange
--------------	-------------	--------	----------	----------------

aFRR Activation Requested	Activation request	Elia	BSP	aFRRActivationRequested.[TargetMarketPartyID].OutQ
aFRR Activation Request Acknowledged	Reception confirmation of an activation request message	BSP	Elia	aFRRActivationAcknowledged.In.Exch
aFRR Activation Confirmed	Confirmation of an activation request	BSP	Elia	aFRRActivationConfirmed.In.Exch
aFRR Activation Confirmation Answered	Answer to a confirmation of activation request message	Elia	BSP	aFRRActivationConfirmationAnswered.[TargetMarketPartyID].OutQ

Error queues

This table contains the queues and exchanges to send and receive message only in case of error:

Message Type	Sender	Receiver	Queue/Exchange
aFRR Activation Requested	BSP	Elia	aFRRActivationRequested.Error.Exch
aFRR Activation Request Acknowledged	Elia	BSP	aFRRActivationAcknowledged.[TargetMarketPartyID].ErrorQ
aFRR Activation Confirmed	Elia	BSP	aFRRActivationConfirmed.[TargetMarketPartyID].ErrorQ
aFRR Activation Confirmation Answered	BSP	Elia	aFRRActivationConfirmationAnswered.Error.Exch

10.11.3 Communication test requested message

10.11.3.1 Message granularity

An aFRR communication test request message groups all selected aFRR Energy Bids from a respective BSP covering 1 or multiple quarter hours.

10.11.3.2 Message timeframe

The aFRR communication test request message will be sent at the aFRR Balancing gate closure time. The communication test request will only be scheduled (will always start at the beginning of a quarter-hour).

For a Scheduled Communication Test request, the start and end time communicated in the communication test request message will be the beginning of the first quarter hour of communication test and end of the last quarter hour of communication test.

10.11.3.3 Message description

An [Activation MarketDocument](#) is the message that is used to request an aFRR Communication test.

Activation_MarketDocument

Field Code Changed

(Exactly one element per message)		
Field	Mandatory	Description
mRID	Y	Unique identifier for the MarketDocument
revisionNumber	Y	Version number for the MarketDocument.
Type	Y	Code for type of MarketDocument. Z16 = aFRR Activation Document
process.processType	Y	Code for type of process. A60 = "Scheduled activation"
sender_MarketParticipant.mRID	Y	The identification of the sender (EIC code) 10X1001A1001A094 = Elia
sender_MarketParticipant.marketRole.type	Y	The role code associated with receiver. Fixed value: A04 = System Operator
receiver_MarketParticipant.mRID	Y	The identification of the receiver (EIC code)
receiver_MarketParticipant.marketRole.type	Y	The role code associated with the receiver: A46 = Balancing Service Provider
createdDateTime	Y	The timestamp on which the message was sent
activation_Time_Period.timeInterval	Y	This information provides the start and end date and time of the activation time interval
TimeSeries	Y	Timeseries associated to the market document. It must contain at least one element.

TimeSeries		
Field	Mandatory	Description
mRID	Y	CommunicationTest = Communication Test mRID
businessType	Y	Identifies the reason why an activation is requested. B40 = National congestion management
measurement_Unit.name	Y	MAW (Megawatt)
flowDirection.direction	Y	The coded identification of the direction of energy flow. A01 = UP A02 = DOWN
Period	Y	This list can only contain 1 element

Period		
Field	Mandatory	Description
timeInterval	Y	The start and end date and time of the aFRR activation.
Resolution	Y	Amount of time for each interval in which a data value is defined. Fixed value: PT15M = 15 minutes
Point	Y	List of points associated to the period. It should contain as many point as needed to complete the period.

Point		
Field	Mandatory	Description
position	Y	The interval number defining which position in the timeseries is indicated. It must start at 1.

Quantity	Y	Power requested. The principal quantity identified for a point. We require an accuracy of 1 MW.
----------	---	--

timeInterval		
Field	Mandatory	Description
start	Y	The start date and time of the interval
end	Y	The end date and time of the interval

10.11.4 Communication test acknowledged message

10.11.4.1 Message granularity

One aFRR Communication Test acknowledgement must be sent for each aFRR Communication Test request submitted by Elia.

10.11.4.2 Message timeframe

This acknowledgement must be sent immediately after the reception of the aFRR Communication Test request message.

10.11.4.3 Message description

As described in the definition of acknowledgement message (see [Acknowledgement and answer messages](#)).

Field Code Changed

10.11.5 Communication Test confirmed message

For an aFRR Communication Test, the BSP must confirm the Communication Test request by sending Elia two confirmation messages.

The confirmation messages must be sent after the acknowledgement message.

A confirmation message includes the list of delivery points that will be used to deliver the requested energy as well as the expected contribution per delivery point.

10.11.5.1 Message granularity

A confirmation message is sent for each Communication Test request received. Multiple confirmations cannot be grouped in a same message.

10.11.5.2 Message timeframe

1st activation confirmation message is sent by the BSP for the entire Communication Test at once, at latest 5 minutes after the reception of the Communication Test request.

2nd activation confirmation is sent by the BSP for the entire Communication Test at once, at latest 8 minutes after the end of the last quarter hour of the Communication Test.

10.11.5.3 Message description

A document [ActivationConfirmation MarketDocument](#) is used for this message.

Optional fields of the market document that are not described in this chapter cannot be used.

ActivationConfirmation_MarketDocument (Exactly one element per message)		
Field	Mandatory	Description
mRID	Y	Unique identifier for the market document
revisionNumber	Y	Version number for the MarketDocument
type	Y	Code for type of market document. Z07 = 1 st confirmation Z08 = 2 nd confirmation
sender_MarketParticipant.mRID	Y	The identification number of the sender (EIC code).
Sender_MarketParticipant.marketRole.type	Y	The role code associated with the sender A46 = Balancing Service Provider
receiver_MarketParticipant.mRID	Y	The identification of the receiver (EIC code). 10X1001A1001A094 = Elia
receiver_MarketParticipant.marketRole.type	Y	The role code associated with the receiver A04 = System operator
createdDateTime	Y	The timestamp on which the message was sent
confirmed_MarketDocument.mRID	Y	The market document identification to which is replied
confirmed_MarketDocument.revisionNumber	Y	The market document revision number to which is replied
activation_Time_Period.timeInterval	Y	The start and end date and time of the activation to which all confirmed timeseries refers to
Confirmed_TimeSeries	Y	The timeseries replied to

Confirmed_TimeSeries		
Field	Mandatory	Description
mRID	Y	CommunicationTest = Communication Test mRID
Period	Y	Periods associated to the timeseries. This list can only contain 1 element

Period		
Field	Mandatory	Description
timeInterval	Y	The start and end date and time of the activation for the timeseries
resolution	Y	PT15M = 15 minutes
Point	Y	List of points associated to the period. It should contain as many points as needed to complete the period.

Point		
Field	Mandatory	Description
position	Y	The interval number defining which position in the timeseries is indicated
quantity	Y	The principal quantity identified for a point. We require an accuracy of 1 MW.
RegisteredResource	Y	List of registered resources associated to this point. It contains the delivery points used for the activation, with their contribution

RegisteredResource		
Field	Mandatory	Description
mRID	Y	EAN code of a delivery point 999999999999999999999999 = Default Delivery point EAN
quantity	Y	Expected contribution per delivery point. The principal quantity identified for a point. We require an accuracy of 1 MW.

timeInterval		
Field	Mandatory	Description
start	Y	Start time of the interval
end	Y	End time of the interval

10.11.6 Validation of an activation confirmed message

This information flow will be subject to all generic validation rules. These and the validation rules listed in the table below are further described in the following section of this document: [Validation rules description](#).

Field Code Changed

ID	Validation Rule	Reply Status	Reason Code	Level
ACT_001	Confirmation deadline not respected	Accept with warning	A57	MarketDocument
ACT_002	TimeSeries not matching	Accept with warning	A09	MarketDocument
ACT_003	Resolution inconsistency	Accept with warning	A41	Timeseries
ACT_004	Quantity inconsistency	Accept with warning	A42	MarketDocument
ACT_005	Quantity increased	Accept with warning	A43	MarketDocument
ACT_006	Quantity decreased	Accept with warning	A44	MarketDocument
ACT_007	Resource Object invalid	Accept with warning	A64	Timeseries

10.11.7 Activation confirmation answered message

10.11.7.1 Message granularity

A Communication test confirmation answered message is sent for each Communication test confirmed message received. Multiple validations cannot be grouped in a same message.

10.11.7.2 Message timeframe

A Communication test confirmation answered message is sent as soon as the Communication test confirmed message is processed by Elia.

10.11.7.3 Message description

As described in the definition of answer message (see [Acknowledgement and answer messages](#)).

Field Code Changed

10.12 Submitting Prequalification Bids

10.12.1 Description

This information flow describes the process of submitting Prequalification Bids to the External Communication Layer.

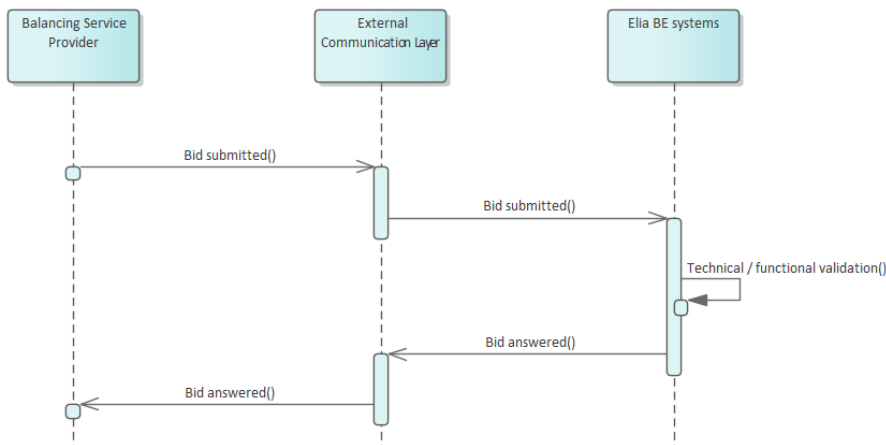

The Balancing Service Provider will send a bid message asynchronously to Elia. The External Communication Layer will treat the message in an asynchronous manner and will reply to it with the result of the validation done in the Elia backend systems.

10.12.2 Queue information

The queues for Prequalification Bids are the same queues as for mFRR and aFRR Energy Bids respectively.

For mFRR Prequalification Bids please see the queue information details of mFRR Energy bids. mFRR Prequalification Bids must be submitted on the same queue used to submit mFRR Energy Bids. The answer to mFRR Prequalification Bids is provided on the same queue as the answers on mFRR Energy Bids. The same error queues as for mFRR Energy Bids are used for mFRR Prequalification Bids.

For aFRR Prequalification Bids please see the queue information details of aFRR Energy bids. aFRR Prequalification Bids must be submitted on the same queue used to submit aFRR Energy Bids. The answer to aFRR Prequalification Bids is provided on the same queue as the answers on aFRR Energy Bids. The same error queues as for aFRR Energy Bids are used for aFRR Prequalification Bids.

10.12.3 Bid submitted message

10.12.3.1 Message granularity

The message granularity for Prequalification Bids is identical to the message granularity of mFRR and aFRR Energy Bids.

For mFRR Prequalification Bids please see the message granularity details of mFRR Energy bids.

For aFRR Prequalification Bids please see the message granularity details of aFRR Energy bids.

10.12.3.2 Message timeframe

For Prequalification Bids no gate opening time is defined. Prequalification Bids can be submitted for any future date. The submission and updates of Prequalification Bids are allowed until the execution date – 1.

10.12.3.3 Message description

Prequalification Bids need to be marked as Prequalification Bids in the message. A dedicated attribute 'businessType' is available for this purpose.

A [ReserveBid_MarketDocument](#) is the message that must be used in order to submit the Prequalification Bids.

Field Code Changed

Optional fields of the market document that are not described in this chapter cannot be used.

ReserveBid_MarketDocument (exactly one element per message)		
Field	Mandatory	Description
mRID	Y	Unique identification of the market document (UUID)
revisionNumber	Y	Version number for the market document
type	Y	Type of market document. Fixed value: A24 = Bid Document
process.processType	Y	Code for type of process: A47 = Manual frequency restoration reserve A51 = Automatic frequency restoration reserve
sender_MarketParticipant.mRID	Y	The identification of the sender (EIC code)
sender_MarketParticipant.marketRole.type	Y	The role code associated with the sender: A46 = Balancing Service Provider
receiver_MarketParticipant.mRID	Y	The identification of the receiver (EIC code). Fixed value: 10X1001A1001A094 = Elia
receiver_MarketParticipant.marketRole.type	Y	The role code associated with the receiver: A04 = System Operator
createdDateTime	Y	The date and time of the creation of the document
reserveBid_Period.timeInterval	Y	The beginning and ending date and time of the period covered by the document
Bid_TimeSeries	Y	Bid timeseries associated to the market document. It must contain at least one element.

Bid_TimeSeries		
Field	Mandatory	Description
mRID	Y	Unique identification of the bid timeseries within the market document
status	N	Only used in case of cancellation, with the following code: A09 = Cancelled

businessType	Y	Identifies the trading nature of the timeseries: Z11 = Prequalification Bid
bidGroupld	Y	The unique identification used to identify associated bids with each other into a Bid Group. The Bid Group Id will be used as activation reference together with the quarter hour concerned by the activation. This identification is defined by the sender and must be unique
ProvidingGroup	Y	The Delivery Points that form the Providing Group to which these bids are related. The list should contain at least one element.
flowDirection.direction	Y	The coded identification of the direction of energy flow. A01 = UP A02 = DOWN
Period	Y	List of periods associated to the timeseries. It should contain at least one element.

Period		
Field	Mandatory	Description
timeInterval	Y	The start and end date and time of the period
resolution	Y	PT15M = 15 minutes
Point	Y	List of points associated to the period. It should contain as many point as needed to complete the period.

Point		
Field	Mandatory	Description
position	Y	The interval number defining which position in the timeseries is indicated. It must start at 1.
Quantity.quantity	Y	The maximum Bid Volume offered in the bid
energy_Price.amount	Y	Price in euro for each offered MWh. For Prequalification Bids this must be 0

RegisteredResource		
Field	Mandatory	Description
mRID	Y	EAN code of a DeliveryPoint

timeInterval		
Field	Mandatory	Description
start	Y	The start date and time of the interval
end	Y	The end date and time of the interval

10.12.4 Validation of a bid submitted message

This information flow will be subject to all generic validation rules. These and the validation rules listed in the table below are further described in the following section of this document: [Validation rules description](#).

All threshold values used in the validation rules are subject to change and will be defined in the contract.

The validations which are applicable on mFRR and aFRR Prequalification Bids are identical to the validations on mFRR and aFRR Energy Bids respectively and are listed in the tables below. Additional validation rules are only applicable on mFRR and aFRR Prequalification Bids are also found in the tables.

10.12.4.1 Validations on bid structure and time

ID	Validation Rule	Reply Status	Reason Code	Level
BID_001	The time period of the message must exactly cover one day	Reject message	Y86	MarketDocument
BID_002	All timeseries within the same message must have the same Providing Group	Reject message	Y84	MarketDocument
BID_003	The bid timeseries period interval must be a multiple of the resolution (default 15 min)	Reject message	A41	Timeseries
BID_005	The same MarketDocument mRID must be used per Providing Group, per MarketDocument time interval	Reject message	Y82	MarketDocument
BID_008	A Delivery Point can only be part of one Providing Group on one quarter hour on an execution date	Reject message	Y79	Timeseries
BID_049	A Prequalification Bid must contain a bid for every quarter hour of the execution day	Reject message	Y36	MarketDocument
Bid_050	A Prequalification Bid message can only contain Prequalification Bids	Reject message	Y35	MarketDocument
BID_065	It is not allowed to change the cancellation status for timeseries that have bids in the past	Reject message	Y14	Timeseries

10.12.4.2 Validations on Delivery Point

ID	Validation Rule	Reply Status	Reason Code	Level
BID_011	The Delivery Point must be included in a contract valid on the execution date for the bids %EAN%	Reject message	Y76	MarketDocument
BID_012	If a DP _{SU} Delivery Point is included in the Providing Group, then all other Delivery Points from that Providing Group must belong to the same Technical Facility	Reject message	Y75	MarketDocument
BID_051	A Delivery Point used in a Prequalification Bid cannot be included in an mFRR bid or an aFRR bid or in another Prequalification Bid or be listed as an mFRR Backup Delivery Point or as an aFRR Backup Delivery Point on the same execution date	Reject message	Y42	MarketDocument

Field Code Changed

10.12.4.3 Validations on Bid Volume

ID	Validation Rule	Reply Status	Reason Code	Level
BID_052	The Bid Volume must be greater than zero	Reject message	Y34	Timeseries
BID_053	Bid Volume granularity for Prequalification Bids is equal to 0,1 MW	Reject message	Y71	Timeseries
BID_020	For mFRR Prequalification bids: The Bid Volume must be smaller than or equal to the sum of the values of $DP_{mFRR,max}$	Reject message	Y69	Timeseries
BID_023	For aFRR Prequalification bids: The Bid Volume must be smaller than or equal to the sum of the values of $DP_{aFRR,max}$	Reject message	Y69	Timeseries
BID_054	The Bid Volume for all bids in a Prequalification Bid message must be identical	Reject message	Y33	Timeseries
BID_064	For symmetrical aFRR Prequalification bids: The Bid Volume in the upward and downward direction must be the same	Reject message	Y15	Timeseries

10.12.4.4 Validations on Bid Price

ID	Validation Rule	Reply Status	Reason Code	Level
BID_055	The Bid Price for Prequalification Bids must be equal to zero	Reject message	Y32	Timeseries

10.12.4.5 Validations on bid linking

ID	Validation Rule	Reply Status	Reason Code	Level
BID_040	No technical linking is allowed across Providing Groups	Reject message	Y41	Timeseries
BID_086	It is not allowed to update the Bid Group Id of existing timeseries	Reject message	X85	Timeseries

Formatted Table

10.12.4.6 Validations on timelines

ID	Validation Rule	Reply Status	Reason Code	Level
BID_056	The execution date in the message must be greater than the current date	Reject message	Y31	MarketDocument

10.12.5 Bid answered message

The bid answered message for Prequalification Bids is identical to the bid answered message of mFRR and aFRR Energy Bids.

As described in the definition of answer message (see [Acknowledgement and answer messages](#)).

Field Code Changed

10.13 Receiving bid confirmations

10.13.1 Description

This information flow is designed to inform the BSPs on the status of bids that were updated after BE GCT.

In case an aFRR bid is updated after BE GCT, Elia has to request an update to the European platforms (PICASSO for aFRR). The bid update will be validated when, and if, Elia receives the confirmation of the update from the concerned platform. If the update is rejected by the platform or if no confirmation is received at the beginning of the validity period of the bid (for PICASSO), the updated bid will be rejected.

Elia informs the Market Party via a bid confirmation message as soon as the bid update is validated or rejected.

For mFRR, in order to allow certain market mechanisms (such as BRP self balancing, reactive balancing or intra-day market trade) to take place, all bids submitted will be automatically validated by Elia except if the update is sent after an activation request containing the bid has been submitted to the BSP. In such case, the rejection will take place at the moment of the message submission and not via bid confirmation following the principles described in the present chapter.

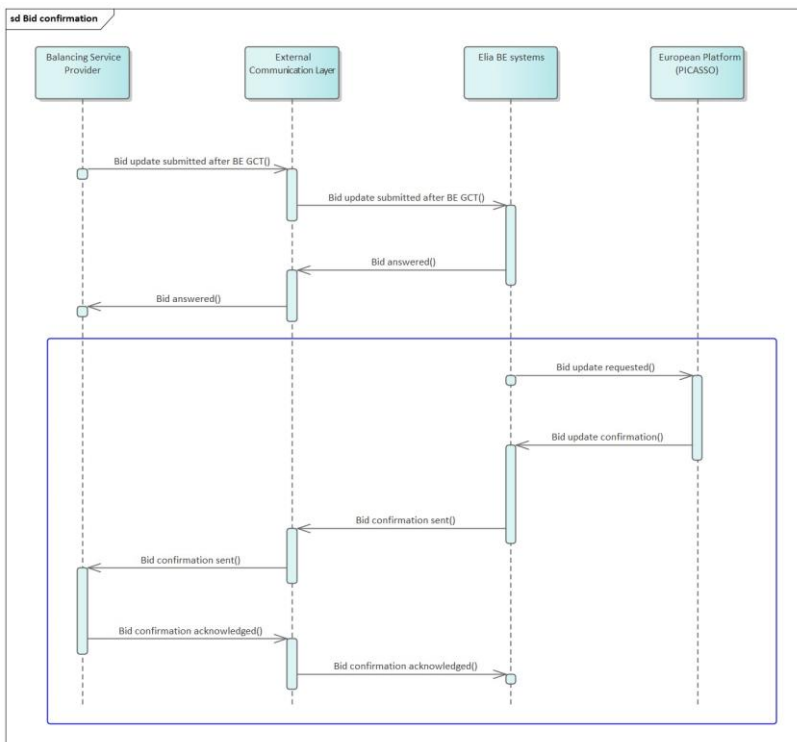

10.13.2 Queue information

This table contains the queues and exchanges to send and receive messages in a normal scenario:

aFRR Bidding

Message Type	Description	Sender	Receiver	Queue/Exchange
aFRR Bid Confirmation Submitted	Submission of a bid confirmation message	Elia	BSP	aFRRBidConfirmationSubmitted.[TargetMarketPartyID].OutQ
aFRR Bid Confirmation Acknowledged	Reception acknowledgment of a bid confirmation message	BSP	Elia	aFRRBidConfirmationAcknowledged.In.Exch

Error queues

This table contains the queues and exchanges to send and receive message only in case of error:

aFRR Bidding

Message Type	Sender	Receiver	Queue/Exchange
aFRR Bid Confirmation Submitted	BSP	Elia	aFRRBidConfirmationSubmitted.Error.Exch
aFRR Bid Confirmation Acknowledged	Elia	BSP	aFRRBidConfirmationAcknowledged.[TargetMarketPartyID].ErrorQ

10.13.3 Bid confirmation message

10.13.3.1 Message granularity

A message will be sent for each Market Document version containing updates for bids after BE GCT.

10.13.3.2 Message timeframe

The messages will be returned as soon as Elia BE systems have the confirmation on the updated bid from the European Platforms or at the start of the validity period of the bids (PICASSO). If a certain bid is updated before it was sent to the platform, only the updated bid will be treated.

10.13.3.3 Message description

A document is used for the Bid Confirmation message.

BidConfirmation_MarketDocument (exactly one element per message)		
Field	Mandatory	Description
mRID	Y	Unique identifier for the market document.

Type	Y	Code for type of the MarketDocument. Z12 = Bid Validation Document
process.processType	Y	Code for type of process: A51 = Automatic frequency restoration reserve
sender_MarketParticipant.mRID	Y	The identification number of the sender (EIC code). The value must be 10X1001A1001A094 = Elia
sender_MarketParticipant.marketRole.type	Y	The role code associated with the sender A04 = System Operator
receiver_MarketParticipant.mRID	Y	The identification ID of the receiver (EIC code).
Receiver_MarketParticipant.marketRole.type	Y	The role code associated with the receiver A46 = Balancing Service Provider
createdDateTime	Y	The timestamp on which the confirmation message was sent
confirmed_MarketDocument.mRID	Y	mRID of the MarketDocument that is being replied
confirmed_MarketDocument.revisionNumber	Y	revisionNumber of the MarketDocument that is being replied to
bidConfirmation_Period.timeInterval	Y	The beginning and ending date and time of the period covered by the document
Confirmed_TimeSeries	Y	The timeseries replied to.

Confirmed_TimeSeries		
Field	Mandatory	Description
mRID	Y	mRID of the timeseries replied to
Period	Y	List of periods associated to the timeseries. It should contain at least one element.

Period		
Field	Mandatory	Description
timeInterval	Y	The start and end date and time of the period
resolution	Y	PT15M = 15 minutes
Point	Y	List of points associated to the period. This message will contain the points updated after BE GCT.

Point		
Field	Mandatory	Description
position	Y	The interval number defining which position in the timeseries is indicated. It must start at 1.
Quantity.quantity	Y	The Bid Volume offered in the bid
quantity.lastConfirmedQuantity	Y	The Bid Volume of the last confirmed and validated bid for this quarter hour
Reason	Y	List of reasons associated to the point. This will determine the status of the bid with respect to the European platforms. Maximum one element.

Reason		
Field	Mandatory	Description
code	Y	For BidConfirmation_MarketDocument: Y18 = Point is considered valid and is the reference bid for activation of this quarter hour Y17 = Point is not considered valid and is thus not the reference bid for activation of this quarter hour

timeInterval		
Field	Mandatory	Description
start	Y	The start date and time of the interval
end	Y	The end date and time of the interval

10.13.4 Bid confirmation acknowledged message

10.13.4.1 Message granularity

An acknowledgement must be sent for each bid confirmation message received.

10.13.4.2 Message timeframe

The acknowledgement message must be sent at the moment of the reception of the bid confirmation message.

10.13.4.3 Message description

As described in the definition of acknowledgement message (see [Acknowledgement and answer messages](#)).

Field Code Changed

10.14 Receiving CRI levels

10.14.1 Description

This message informs the Market Parties about the CRI levels. The message contains medium or high CRI level indicators per direction and electrical zone per quarter hour. The potentially impacted Delivery Points and Energy Bids of the BSP will also be provided in the message.

An acknowledgement message will be expected after the reception of the CRI level message.

This information flow describes the process of providing CRI level information.

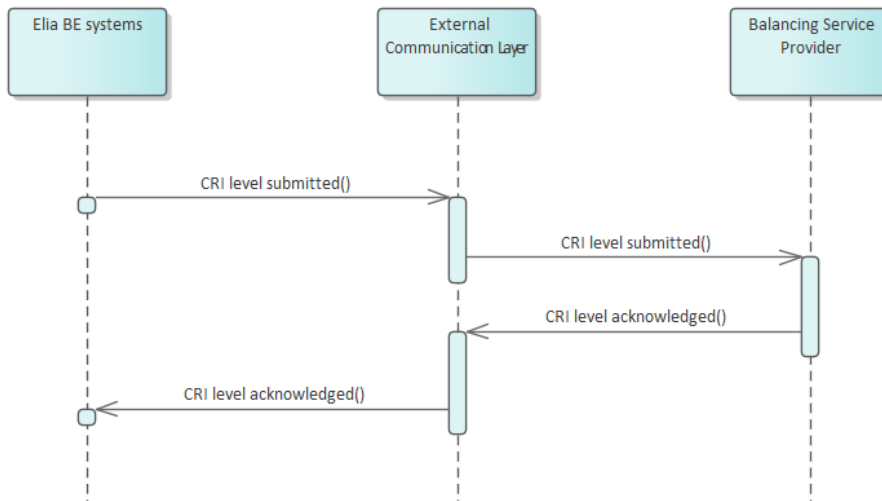

10.14.2 Queue information

This table contains the queues and exchanges to send and receive messages in a normal scenario.

aFRR

Message Type	Description	Sender	Receiver	Queue/Exchange
aFRR CRI Level Submitted	Submission of a CRI level message	Elia	BSP	aFRRCRILevelSubmitted.[TargetMarketPartyID].OutQ
aFRR CRI Level Acknowledged	Reception confirmation of a CRI level message	BSP	Elia	aFRRCRILevelAcknowledged.In.Exch

mFRR

Message Type	Description	Sender	Receiver	Queue/Exchange
mFRR CRI Level Submitted	Submission of a CRI level message	Elia	BSP	mFRRCRILevelSubmitted.[TargetMarketPartyID].OutQ
mFRR CRI Level Acknowledged	Reception confirmation of a CRI level message	BSP	Elia	mFRRCRILevelAcknowledged.In.Exch

Error queues

This table contains the queues and exchanges to send and receive message only in case of error.

aFRR

Message Type	Sender	Receiver	Queue/Exchange
aFRR CRI Level Submitted	BSP	Elia	aFRRCRILevelSubmitted.Error.Exch
aFRR CRI Level Acknowledged	Elia	BSP	aFRRCRILevelAcknowledged.[TargetMarketPartyID].ErrorQ

mFRR

Message Type	Sender	Receiver	Queue/Exchange
mFRR CRI Level Submitted	BSP	Elia	mFRRCRILevelSubmitted.Error.Exch
mFRR CRI Level Acknowledged	Elia	BSP	mFRRCRILevelAcknowledged.[TargetMarketPartyID].ErrorQ

10.14.3 CRI level submitted message

10.14.3.1 Message granularity

The granularity of the CRI level message is set at execution date level. Meaning that a CRI level message is provided per day which indicates the CRI level per direction and electrical zone on a quarter hourly basis.

10.14.3.2 Message timeframe

The CRI levels will be communicated at regular intervals.

10.14.3.3 Message description

A document [CRILevel_MarketDocument](#) is used for the CRI level message.

Field Code Changed

CRILevel_MarketDocument (exactly one element per message)		
Field	Mandatory	Description
mRID	Y	Unique identification of the market document
revisionNumber	Y	Version number for the market document
type	Y	Type of market document. Z10 = CRI Level Document
process.processType	Y	Code for type of process: A47 = Manual frequency restoration reserve A51 = Automatic frequency restoration reserve
sender_MarketParticipant.mRID	Y	The identification number of the sender (EIC code). Fixed value: 10X1001A1001A094 = Elia
sender_MarketParticipant.marketRole.type	Y	The role code associated with sender. Fixed value: A04 = System Operator
receiver_MarketParticipant.mRID	Y	The identification ID of the receiver (EIC code)
receiver_MarketParticipant.marketRole.type	Y	The role code associated with receiver. Fixed value: A46 = Balancing Service Provider

createdDateTime	Y	The date and time of the creation of the document
CRIlevel_Period.timeInterval	Y	The beginning and ending date and time of the period covered by the document
CRIlevel_TimeSeries	Y	CRIlevel_TimeSeries contained in the message

CRIlevel_TimeSeries		
Field	Mandatory	Description
mRID	Y	Unique identification of the CRIlevel_TimeSeries within the market document
flowDirection.direction	Y	The coded identification of the direction of energy flow. A01 = UP A02 = DOWN
electricalZone	Y	Name of the electrical zone
Period	Y	List of Period

Period		
Field	Mandatory	Description
timeInterval	Y	The start and end date and time of the period
resolution	Y	Amount of time for each interval in which a data value is defined. Fixed value: PT15M = 15 minutes
Point	Y	List of Point

Point		
Field	Mandatory	Description
position	Y	The interval number defining which position in the period is indicated
CRIlevel	Y	CRI level indicator Possible values: Z01 = High Z02 = Medium Z03 = Low ⁵
Mwcap	N	MW capping to be applied
ImpactedBid	N	List of Energy Bid Group Ids for which bids can be impacted by the corresponding CRI level
ImpactedDeliveryPoint	N	List of Delivery Points in an Energy Bid or a Backup DP interval that can be impacted by the corresponding CRI level

timeInterval

⁵ Low CRI levels will be sent as from the moment a medium or high level is detected and then for all subsequent versions. If no message is received, the CRI levels remained low for the whole day. Low levels will never be accompanied by impacted bids or Delivery Points.

Field	Mandatory	Description
start	Y	The start date and time of the interval
end	Y	The end date and time of the interval

ImpactedBid		
Field	Mandatory	Description
bidGroupld	Y	The Bid Group Id used in the bid submission messages

RegisteredResource		
Field	Mandatory	Description
mRID	Y	EAN code of a DeliveryPoint

10.14.4 CRI level acknowledged message

10.14.4.1 Message granularity

An acknowledgement must be sent for each CRI level message received.

10.14.4.2 Message timeframe

The acknowledgement message must be sent at the moment of the reception of the CRI level message.

10.14.4.3 Message description

As described in the definition of acknowledgement message (see [Acknowledgement and answer messages](#)).

Field Code Changed

10.15 Receiving a Market Party notification

10.15.1 Description

This message exchange is described in the following section: [Notification messages](#).

Field Code Changed

10.15.2 Queue information

The following tables contain the queues and exchanges to send and receive messages in a normal scenario:

Message Type	Description	Sender	Receiver	Queue/Exchange
Balancing Service Provider Market Notification Submitted	Submission of a Market Party notification	Elia	BSP	BalancingServiceProviderNotificationSubmitted.[TargetMarketPartyID].OutQ
Balancing Service Provider Market Notification Received	Reception confirmation of a Market Party notification	BSP	Elia	BalancingServiceProviderNotificationAcknowledged.In.Exch

Error queues

The following tables contain the queues and exchanges to send and receive message only in case of error:

Message Type	Sender	Receiver	Queue/Exchange
Balancing Service Provider Market Notification Submitted	BSP	Elia	BalancingServiceProviderNotificationSubmitted.Error.Exch
Balancing Service Provider Market Notification Received	Elia	BSP	BalancingServiceProviderNotificationAcknowledged.[TargetMarketPartyID].ErrorQ

10.16 Retrieving Energy Bids

10.16.1 Description

This message exchange allows the Balancing Service Provider to retrieve previously submitted Energy Bids⁶ via the External Communication Layer. Elia will only return the latest accepted Market Documents at the time of the query following the request.

This information flow describes the process of requesting bid details to the External Communication Layer.

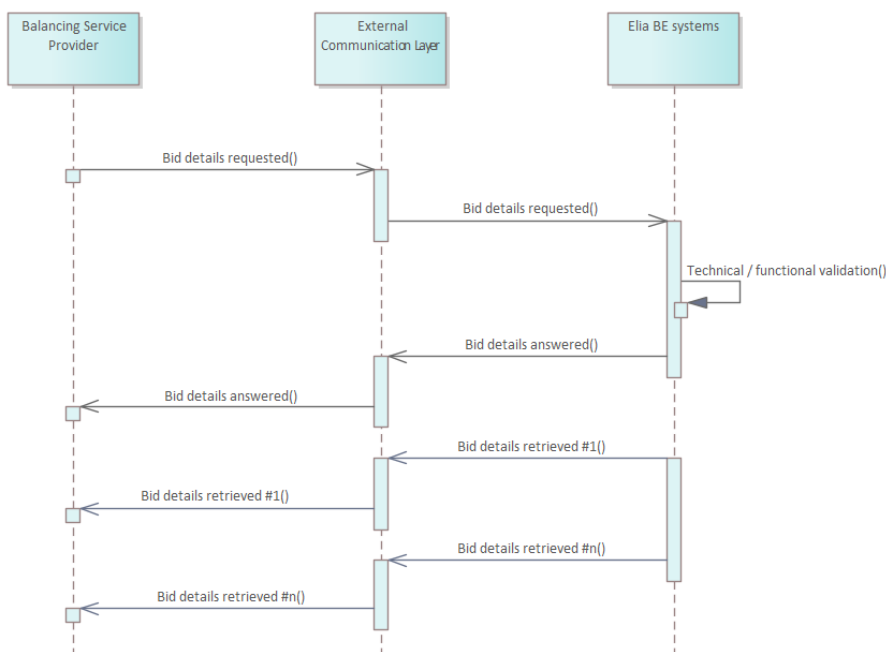

10.16.2 Queue information

This table contains the queues and exchanges to send and receive messages in a normal scenario. The Bid Details Answered queue will be used to indicate whether the request was valid and whether or not results were found. If the request was valid and results were found, they will be published on the Bid Details Retrieved queue.

aFRR

Message Type	Description	Sender	Receiver	Queue/Exchange
aFRR Bid Details Requested	Requesting Energy Bids to be retrieved	BSP	Elia	aFRREnergyBidDetailsRequested.In.Exch

⁶ Only Energy Bids can be requested, not Prequalification Bids nor Backup Delivery Points

aFRR Bid Details Retrieved	The result of the requested Energy Bids	Elia	BSP	aFRREnergyBidDetailsRetrieved.[TargetMarketPartyID].OutQ
aFRR Bid Details Answered	The answer to the request message	Elia	BSP	aFRREnergyBidDetailsAnswered.[TargetMarketPartyID].OutQ

mFRR

Message Type	Description	Sender	Receiver	Queue/Exchange
mFRR Bid Details Requested	Requesting Energy Bids to be retrieved	BSP	Elia	mFRREnergyBidDetailsRequested.In.Exch
mFRR Bid Details Retrieved	The result of the requested Energy Bids	Elia	BSP	mFRREnergyBidDetailsRetrieved.[TargetMarketPartyID].OutQ
mFRR Bid Details Answered	The answer to the request message	Elia	BSP	mFRREnergyBidDetailsAnswered.[TargetMarketPartyID].OutQ

Error queues

This table contains the queues and exchanges to send and receive message only in case of error.

aFRR

Message Type	Sender	Receiver	Queue/Exchange
aFRR Bid Details Requested	Elia	BSP	aFRREnergyBidDetailsRequested.[TargetMarketPartyID].ErrorQ
aFRR Bid Details Retrieved	BSP	Elia	aFRREnergyBidDetailsRetrieved.Error.Exch
aFRR Bid Details Answered	BSP	Elia	aFRREnergyBidDetailsAnswered.Error.Exch

mFRR

Message Type	Sender	Receiver	Queue/Exchange
mFRR Bid Details Requested	Elia	BSP	mFRREnergyBidDetailsRequested.[TargetMarketPartyID].ErrorQ
mFRR Bid Details Retrieved	BSP	Elia	mFRREnergyBidDetailsRetrieved.Error.Exch
mFRR Bid Details Answered	BSP	Elia	mFRREnergyBidDetailsAnswered.Error.Exch

10.16.3 Energy bid details requested message

10.16.3.1 Message granularity

Requesting Energy Bids will be limited to one execution day and can be filtered using input parameters. If these are not used, all relevant Market Documents for the requested period will be returned. In the retrieval, Elia will send back each Market Document in a separate message.

10.16.3.2 Message timeframe

Requests will be limited in frequency and period for performance reasons as described in the validation rules.

10.16.3.3 Message description

A document [Request_MarketDocument](#) is used for the Energy Bid Request.

Field Code Changed

Request_MarketDocument (exactly one element per message)		
Field	Mandatory	Description
mRID	Y	Unique identification of the Request Market Document
type	Y	Type of market document. Z14 = Bid Request
process.processType	Y	Code for type of process: A47 = Manual frequency restoration reserve A51 = Automatic frequency restoration reserve
sender_MarketParticipant.mRID	Y	The identification of the sender (EIC code)
sender_MarketParticipant.marketRole.type	Y	The role code associated with the sender: A46 = Balancing Service Provider
receiver_MarketParticipant.mRID	Y	The identification number of the sender (EIC code). Fixed value: 10X1001A1001A094 = Elia
receiver_MarketParticipant.marketRole.type	Y	The role code associated with sender. Fixed value: A04 = System Operator
createdDateTime	Y	The date and time of the Request Market Document
request_Period.timeInterval	Y	The beginning and ending date and time of the period covered by the document. This cannot exceed an execution day.
Request_TimeSeries	Y	Request_TimeSeries contained in the message

Request_TimeSeries		
Field	Mandatory	Description
mRID	Y	Unique identification of the Request_TimeSeries within the market document
flowDirection.direction	Y	The coded identification of the direction of energy flow. A01 = UP A02 = DOWN A03 = UP & DOWN
requested_MarketDocument.mRID	N	The Market Document mRID can be set here if a specific Market Document is requested. If not used, this filter is not applied.
RequestedProvidingGroup	N	The Delivery Points that form the Providing Group to which these bids are related. When used, the exact set of Delivery Points in the Providing Group must match or no results will be returned. If not used, this filter is not applied.

timeInterval		
Field	Mandatory	Description
start	Y	The start date and time of the interval
end	Y	The end date and time of the interval

RegisteredResource		
Field	Mandatory	Description
mRID	Y	EAN code of a DeliveryPoint

10.16.4 Validation of an energy bid details requested message

This information flow will be subject to all generic validation rules. These and the validation rules listed in the table below are further described in the following section of this document: [Validation rules description](#).

Request messages that are rejected will be answered with the Answer message as described in the definition of answer message (see [Acknowledgement and answer messages](#)). When the request is valid, the Energy Bid Retrieval message described in the next section will be returned.

10.16.4.1 Validations on request process

ID	Validation Rule	Reply Status	Reason Code	Level
REQ_001	The request did not generate any results	Accepted with warnings	Y11	MarketDocument
REQ_002	The number of requests per 15 minutes cannot exceed the threshold limit	Reject message	Y10	MarketDocument
REQ_003	The request can cover maximum one execution day	Reject message	Y09	MarketDocument

10.16.5 Energy bid details retrieved message

10.16.5.1 Message granularity

For bidding, the granularity is set at the Providing Group and the bid execution date level. Meaning that for each combination of these objects, we will send exactly one single message. So if the request requires multiple Providing Groups, these will be split per message, similarly to the bid submission. In the retrieved message we will only send back the last accepted version of a Market Document.

10.16.5.2 Message timeframe

The message(s) will be returned as soon as possible after a valid request was made.

10.16.5.3 Message description

ReserveBid_MarketDocument (exactly one element per message)		
Field	Mandatory	Description
mRID	Y	Unique identification of the MarketDocument (UUID) that was retrieved
revisionNumber	Y	Version number for the market document that was retrieved
Type	Y	Type of MarketDocument. Fixed value: A24 = Bid Document
process.processType	Y	Code for type of process: A47 = Manual frequency restoration reserve

Field Code Changed

Field Code Changed

		A51 = Automatic frequency restoration reserve
sender_MarketParticipant.mRID	Y	The identification number of the sender (EIC code). Fixed value: 10X1001A1001A094 = Elia
sender_MarketParticipant.marketRole.type	Y	The role code associated with sender. Fixed value: A04 = System Operator
receiver_MarketParticipant.mRID	Y	The identification of the sender (EIC code)
receiver_MarketParticipant.marketRole.type	Y	The role code associated with the sender: A46 = Balancing Service Provider
createdDateTime	Y	The date and time of the reception of the Market Document by Elia
reserveBid_Period.timeInterval	Y	The begin and end date and time of the period covered by the document
Bid_TimeSeries	Y	Bid timeseries associated to the market document. It must contain at least one element.

Bid_TimeSeries		
Field	Mandatory	Description
mRID	Y	Unique identification of the bid timeseries within the MarketDocument
Status	N	Only used in case of cancellation, with the following code: A09 = Cancelled
auction.mRID	Y	Possible values : Z01 = Non-contracted Z02 = Contracted
businessType	Y	Identifies the trading nature of the timeseries: B74 = Offer
bidGroupId	Y	The unique identification used to identify associated bids with each other into a Bid Group. This identification is defined by the sender and must be unique
multipartBidIdentification	N	The identification used to associate parent child bids. If the bid is not part of parent child group then the attribute is not used. This identification is defined by the sender and must be unique
exclusiveBidsIdentification	N	The identification used to associate exclusive bids. If the bid is not exclusive then the attribute is not used. It allows only one element in this list. This identification is defined by the sender and must be unique
ProvidingGroup	Y	The Delivery Points that form the Providing Group to which these bids are related. The list should contain at least one element.
BidGroup	N	The specific Delivery Points to which the Bid Group is related.
flowDirection.direction	Y	The coded identification of the direction of energy flow. A01 = UP A02 = DOWN

maximum_ConstraintDuration.duration	N	Maximum Activation time (MAT) (in min) during which the maximum bid volume can be activated. If no value is provided, then there is no limitation on the maximum constraint duration.
Neutralization_Duration.duration	N	If the activation of a bid is not prolonged, the Neutralization Time (NT) (in min) is the time during which the bid volume cannot be activated after a previous activation If no value is provided, then there is no neutralization time.
Linked_BidTimeSeries	N	List of conditionally linked bid timeseries. There is a maximum of 6 elements allowed in this list.
Period	Y	List of periods associated to the timeseries. It should contain at least one element.

Period		
Field	Mandatory	Description
timeInterval	Y	The start and end date and time of the period
resolution	Y	PT15M = 15 minutes
point	Y	List of points associated to the period. It should contain as many point as needed to complete the period.

Point		
Field	Mandatory	Description
Position	Y	The interval number defining which position in the timeseries is indicated. It must start at 1.
Status	Y	Z01 – Validated Z02 – Waiting for confirmation Z03 – Rejected
quantity.quantity	Y	The maximum Bid Volume offered in the bid
lastConfirmed_Quantity.quantity	Y	The last validated maximum Bid Volume offered in the bid. Can be different from the last accepted volume when the status of the bid is not validated.
minimum_Quantity.quantity	N	The minimum volume that must be activated for this bid. If no value is provided, a default of 0 MW will be considered.
energy_Price.amount	Y	Price in euro for each offered MWh
maximum_EnergyLevel.energy	N	The Maximum Energy Level (MEL) indicates the maximum remaining energy for the Providing Group. If no value is provided, no limitation will be considered.
Standard_MarketProduct.marketProductType	N	Possible values: A05 = Standard mFRR product eligible for scheduled activation only A07 = Standard mFRR product eligible for scheduled and direct activation

		If no value is provided, a default value of A07 will be used.
PointGroup	N	The specific delivery points to which the interval of this bid is related.
Reason	N	List of reasons associated to the point. Maximum one element.

Linked_BidTimeSeries		
Field	Mandatory	Description
mRID	Y	The bidGroupID to which the conditional link refers to
status	Y	The condition of the conditional linked bid: A55 = Not available if linked bid activated A56 = Not available if linked bid rejected A57 = Not available for DA if linked bid subject to DA A58 = Not available for DA if linked bid subject to SA A59 = Not available if linked bid subject to SA A60 = Not available if linked bid subject to DA A67 = Available if linked bid activated A68 = Available if linked bid rejected A69 = Available if linked bid subject to SA A70 = Available if linked bid subject to DA A71 = Available for DA if linked bid subject to DA A72 = Available for DA if linked bid subject to SA
level	Y	The level determines the position of the bid within the linked Bid Group with respect to the current bid: 1 = refers to t-1 of the linked bid with respect to the current position of this bid 2 = refers to t-2 of the linked bid with respect to the current position of this bid

RegisteredResource		
Field	Mandatory	Description
mRID	Y	EAN code of a DeliveryPoint

Reason		
Field	Mandatory	Description
code	Y	Y24 = Forced Outage B46 = Internal Congestion (DP activated for redispatching) Y25 = Other Y07 = Disabled by Elia Y08 = CRI filtered <u>X86 = Activation at Own Expense</u>

Formatted: Font: Bold

timeInterval		
Field	Mandatory	Description
start	Y	The start date and time of the interval
end	Y	The end date and time of the interval

10.16.6 Energy bid details answered message

The bid answered message for Energy bid details requested is identical to the bid answered message of mFRR and aFRR Energy Bids.

As described in the definition of answer message (see [Acknowledgement and answer messages](#)).

Field Code Changed

10.17 Retrieving schedule update for mFRR baseline

10.17.1 Description

This message exchange allows the Balancing Service Provider to retrieve previously submitted schedule updates for mFRR baseline via the External Communication Layer. Elia will only return the latest accepted Market Documents at the time of the query following the request.

This information flow describes the process of requesting schedule update details via the External Communication Layer.

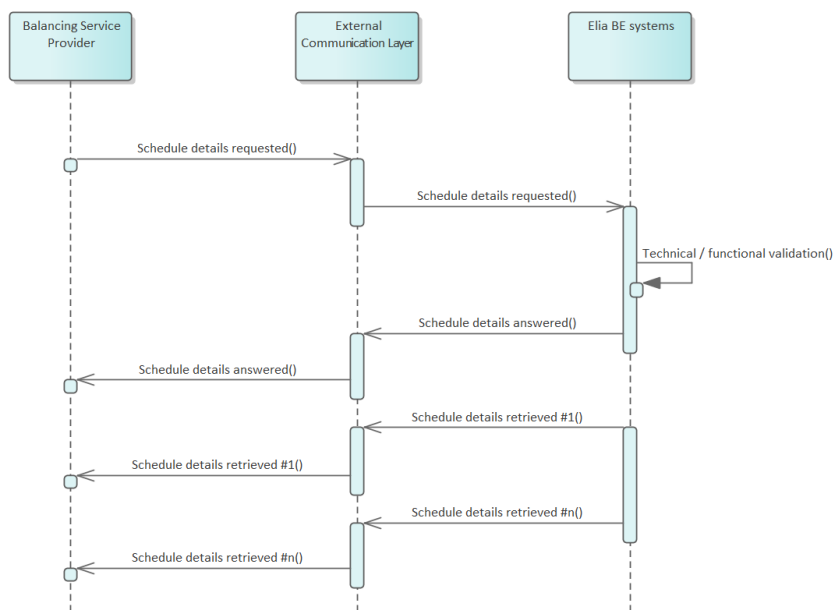

10.17.2 Queue information

This table contains the queues and exchanges to send and receive messages in a normal scenario. The Schedule Details Answered queue will be used to indicate whether the request was valid and whether or not results were found. If the request was valid and results were found, they will be published on the Schedule Retrieved queue.

Message Type	Description	Sender	Receiver	Queue/Exchange
Schedule Update Details Requested	Requesting Schedule updates to be retrieved	BSP	Elia	ScheduleBaselineUpdateDetailsRequested.In.Exch
Schedule Update Details Retrieved	The result of the requested Schedule updates	Elia	BSP	ScheduleBaselineUpdateDetailsRetrieved.[TargetMarketPartyID].OutQ
Schedule Update Details Answered	The answer to the request message	Elia	BSP	ScheduleBaselineUpdateDetailsAnswered.[TargetMarketPartyID].OutQ

Error queues

This table contains the queues and exchanges to send and receive messages only in case of error.

Message Type	Sender	Receiver	Queue/Exchange
Schedule Update Details Requested	Elia	BSP	ScheduleBaselineUpdateDetailsRequested.[TargetMarketPartyID].ErrorQ
Schedule Update Details Retrieved	BSP	Elia	ScheduleBaselineUpdateDetailsRetrieved.Error.Exch
Schedule Update Details Answered	SA	Elia	ScheduleBaselineUpdateDetailsAnswered.Error.Exch

10.17.3 Schedule details requested message

10.17.3.1 Message granularity

Requesting Schedule updates for mFRR baseline will be limited to one execution day and can be filtered using input parameters. If these are not used, all relevant Market Documents for the requested period will be returned. In the retrieval, Elia will send back each Market Document in a separate message.

10.17.3.2 Message timeframe

Requests will be limited in frequency and period for performance reasons as described in the validation rules.

10.17.3.3 Message description

A document [Request_MarketDocument](#) is used for the Schedule Request.

Field Code Changed

Request_MarketDocument (exactly one element per message)		
Field	Mandatory	Description

mRID	Y	Unique identification of the Request Market Document
type	Y	Type of market document. A46 = Schedule update for mFRR baseline Request
process.processType	Y	Code for type of process: A17 = Schedule day
sender_MarketParticipant.mRID	Y	The identification of the sender (EIC code)
sender_MarketParticipant.marketRole.type	Y	The role code associated with the sender: A46 = Balancing Service Provider
receiver_MarketParticipant.mRID	Y	The identification number of the Receiver(EIC code). Fixed value: 10X1001A1001A094 = Elia
receiver_MarketParticipant.marketRole.type	Y	The role code associated with sender. Fixed value: A04 = System Operator
createdDateTime	Y	The date and time of the creation of the Request Market Document
request_Period.timeInterval	Y	The beginning and ending date and time of the period covered by the document. This cannot exceed an execution day.
Request_TimeSeries	Y	Request_TimeSeries contained in the message

Request_TimeSeries		
Field	Mandatory	Description
mRID	Y	Unique identification of the Request_TimeSeries within the market document
requested_MarketDocument.mRID	N	The Market Document mRID can be set here if a specific Market Document is requested. If not used, this filter is not applied.
Requested_RegisteredResource.mRID	N	The delivery point EAN representing the point for which the schedule is sent. If not used, this filter is not applied.

timeInterval		
Field	Mandatory	Description
start	Y	The start date and time of the interval
end	Y	The end date and time of the interval

RegisteredResource		
Field	Mandatory	Description
mRID	Y	EAN code of a DeliveryPoint

10.17.4 Validation of a schedule details requested message

This information flow will be subject to all generic validation rules. These and the validation rules listed in the table below are further described in the following section of this document: [Validation rules description](#).

Request messages that are rejected will be answered with the Answer message as described in the definition of answer message (see [Acknowledgement and answer messages](#)). When the request is valid, the Schedule Retrieval message described in the next section will be returned.

Field Code Changed

Field Code Changed

10.17.4.1 Validations on request process

ID	Validation Rule	Reply Status	Reason Code	Level
REQ_001	The request did not generate any results	Accepted with warnings	Y11	MarketDocument
REQ_002	The number of requests per 15 minutes cannot exceed the threshold limit	Reject message	Y10	MarketDocument
REQ_003	The request can cover maximum one execution day	Reject message	Y09	MarketDocument

10.17.5 Schedule details retrieved message

10.17.5.1 Message granularity

For scheduling, the granularity is set at the Delivery Point and the execution date level. Meaning that for each combination of these objects, we will send exactly one single message. So, if the request requires multiple Delivery Points, these will be split per message. In the retrieved message we will only send back the last accepted version of a Market Document.

10.17.5.2 Message timeframe

The message(s) will be returned as soon as possible after a valid request was made.

10.17.5.3 Message description

Schedule_MarketDocument (Exactly one element per message)		
Field	Mandatory	Value(s)
mRID	Y	Unique identification of the market document (UUID)
revisionNumber	Y	Version number for the market document
type	Y	Type of market document. Fixed value: A46 = Active Power Schedule Update Document
process.processType	Y	Code for type of process: A17 = Schedule day
process.classificationType	Y	Defines whether the schedule is an aggregation or a classification. Fixed value: A01 = detail type
sender_MarketParticipant.mRID	Y	The identification of the receiver (EIC code). Fixed value: 10X1001A1001A094 = Elia
sender_MarketParticipant.marketRole.type	Y	The role code associated with receiver. Fixed value: A04 = System Operator
receiver_MarketParticipant.mRID	Y	The identification of the sender (EIC code)
receiver_MarketParticipant.marketRole.type	Y	The role code associated with sender: A46 = Balancing Service Provider
createdDateTime	Y	The date and time of the reception of the Market Document by Elia
schedule_Time_Period.timeInterval	Y	The start and end date and time of the day to which the schedule update refers to (execution date)
domain.mRID	Y	10YBE-----2 = Belgian bidding zone
TimeSeries	Y	This list only allows 1 element

TimeSeries		
Field	Mandatory	Value(s)
mRID	Y	Sender's identification of the timeseries.
Version	Y	Fixed value: 1
businessType	Y	Identifies the trading nature of the timeseries: Z12 = Net Consumption – Production
product	Y	The energy product of the schedule timeseries. Fixed value: 8716867000016 = active power
objectAggregation	Y	Identifies how the object is aggregated. Fixed value: Z01 = Delivery Point
registeredResource.mRID	Y	The delivery point EAN representing the point for which the schedule is sent
measurement_Unit.name	Y	MAW = expressed scheduled power is in Megawatt
Period	Y	This list only allows 1 element

Period		
Field	Mandatory	Value(s)
timeInterval	Y	The start and end date and time to which the schedule timeseries refer to
resolution	Y	Amount of time for each interval in which a data value is defined. Fixed value: PT15M = 15 minutes
Point	Y	List of points associated to the period. It should contain as many point as needed to complete the period.

Point		
Field	Mandatory	Value(s)
position	Y	The interval number defining which position in the timeseries is indicated. It must start at 1.
Quantity	Y	The list of schedule intervals in which the value (MW) of the scheduled power is given. We require an accuracy of 0.1 MW.

timeInterval		
Field	Mandatory	Value(s)
start	Y	The start date and time of the interval
end	Y	The end date and time of the interval

10.17.6 Schedule details answered message

The bid answered message for Schedule details requested is identical to the Schedule answered message.

As described in the definition of answer message (see [Acknowledgement and answer messages](#)).

Field Code Changed

11 Merged Energy Bids Guide

11.1 Role overview

It is possible that Market Parties at the same time have a Balancing Service Provider role and a Scheduling Agent role. For such Market Parties, Elia facilitates the submission of Merged Energy Bids. A Merged Energy Bid is a bid document which allows submitting mFRR and Redispatching Energy bids simultaneously.

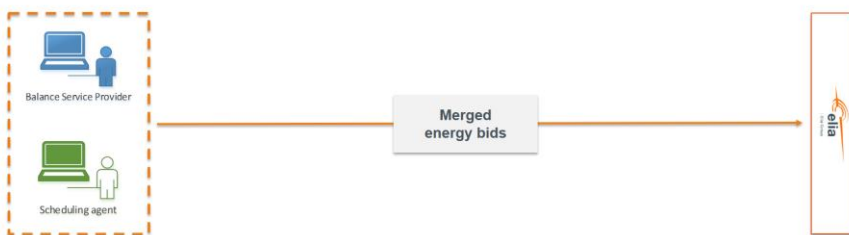

11.1.1 Mechanisms for Merged Energy Bids

11.1.2 Splitting Merged Energy Bids

Upon receipt, the Merged Energy Bid message is split by Elia into an mFRR Energy Bid message and a Redispatching Energy Bid message. Once the message is split, the mFRR Energy Bid message and Redispatching Energy Bid message are processed separately and independently of each other.

Please note that this means that the mFRR Energy Bid message could be accepted while the Redispatching Energy Bid message is rejected and vice-versa. An answered message is provided on the mFRR Bid Answered queue and Redispatching Bid Answered queue respectively.

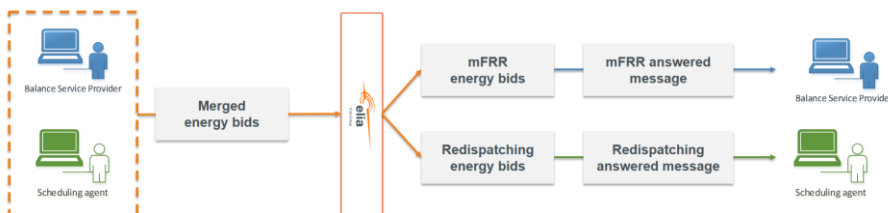

The following mechanisms are applied when splitting the Merged Energy Bid into mFRR Energy Bids and Redispatching Energy Bids.

- The majority of the fields provided in the Merged Energy Bid message are used to create both the mFRR Energy Bids and the Redispatching Energy Bids. This means that no manipulations are done when doing the split of the Merged Bid message and the values of these fields are the same in both messages after the split.

- Fields which are not relevant for a product, are not used in the concerned product.

- In the Merged Energy Bid message, two price fields are provided. The first price field is used for the mFRR Energy Bids and the second price field is used for the Redispatching Energy Bids. This allows the Elia back-end system to differentiate the price between mFRR Energy Bids and Redispatching Energy Bids.

- When splitting the Merged Energy Bid message, fixed values are used for some of the fields. This is done to ensure that the split of the Merged Energy Bid into an mFRR Energy Bid and a Redispatching Energy Bid is correctly executed. The fixed value corresponds with the values needed for mFRR Energy Bids and Redispatching Energy Bids respectively. These fields are:
 - o process.processType:
 - The process type for mFRR (A47) is used for the mFRR Energy Bids.
 - The process type for Redispatching (A41) is used for the Redispatching Energy Bids.
 - o sender_MarketParticipant.marketRole.type:
 - The market role type for Balancing Service Provider (A46) is used for the mFRR Energy Bids.
 - The market role type for Scheduling Agent (Z02) is used for the Redispatching Energy Bids.
 - o activation_ConstraintDuration.duration (FAT):
 - For the mFRR Energy Bids the Full-Activation Time is not relevant and therefore this field is not used in mFRR Energy Bid messages.
 - A fixed value of 12,5 minutes is used for the Full-Activation Time for Redispatching Energy Bids.

- For Bid Timeseries which are representing **contracted** mFRR Energy bids, no equivalent Redispatching Energy Bids are created.

The detailed mapping and use of the fields when splitting the Merged Energy Bid is described in the next paragraph.

11.1.3 Updating Merged Energy Bids

Merged Energy Bid messages contain a version number, just like any other Energy Bid message. Therefore it is possible to update Merged Energy Bids by incrementing the version number of the Merged Energy Bid message and submitting this new version. Both mFRR Energy bids message and Redispatching Energy Bids message inherit the version from Merged bid message.

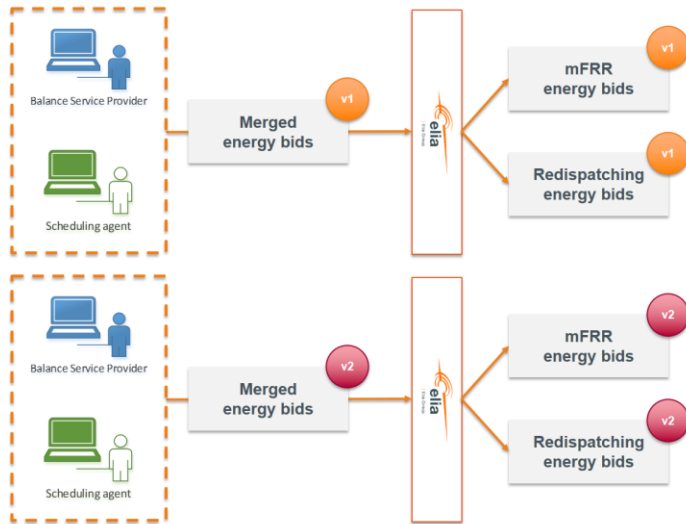

mFRR Energy Bids and Redispatching Energy Bids which are submitted via a Merged Energy Bid message can still be updated via individual mFRR Energy Bids messages or Redispatching Energy Bid messages. This can be done by using the same mRIDs and Providing Group as in the Merged Energy Bid message and by ensuring that the version number of the individual message is higher than the current accepted Energy Bid messages.

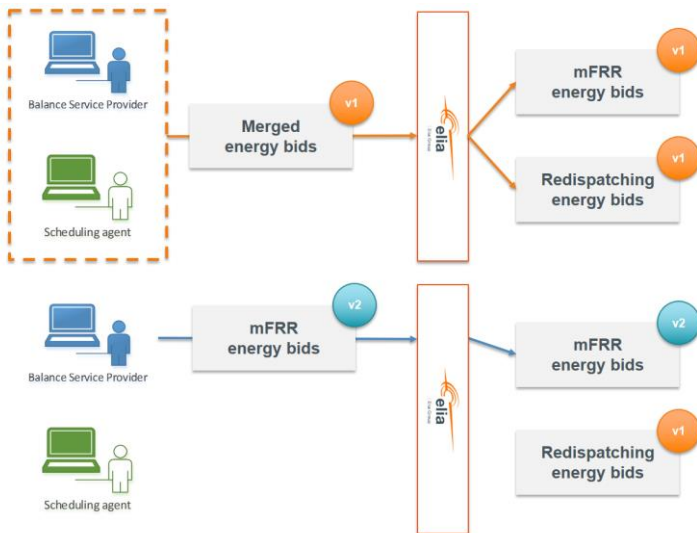

Finally, it is also possible to update the mFRR Energy Bids and Redispatching Energy Bids again via a Merged Energy Bid message. This can be done by using the same mRIDs and Providing Group as in the initial Merged Energy Bid message and by ensuring that the version number of the Merged Energy Bid message is higher than the current accepted Energy Bid messages.

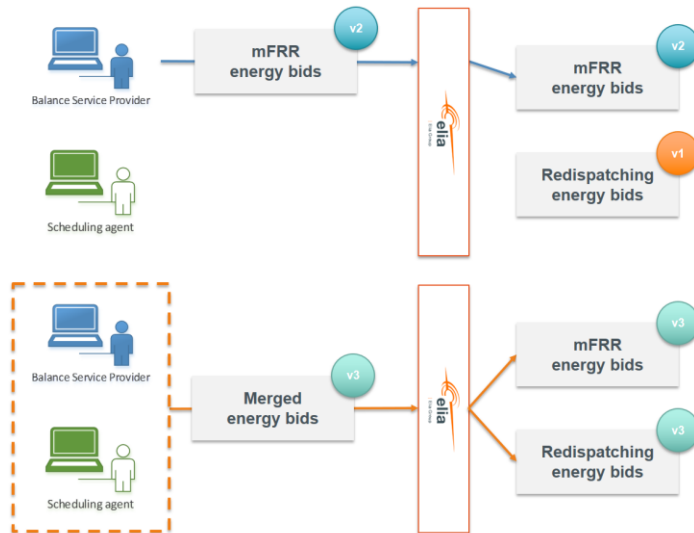

11.2 Submission of merged mFRR and Redispatching Energy Bids

11.2.1 Description

This information flow describes the process of submitting Merged Bids to the External Communication Layer.

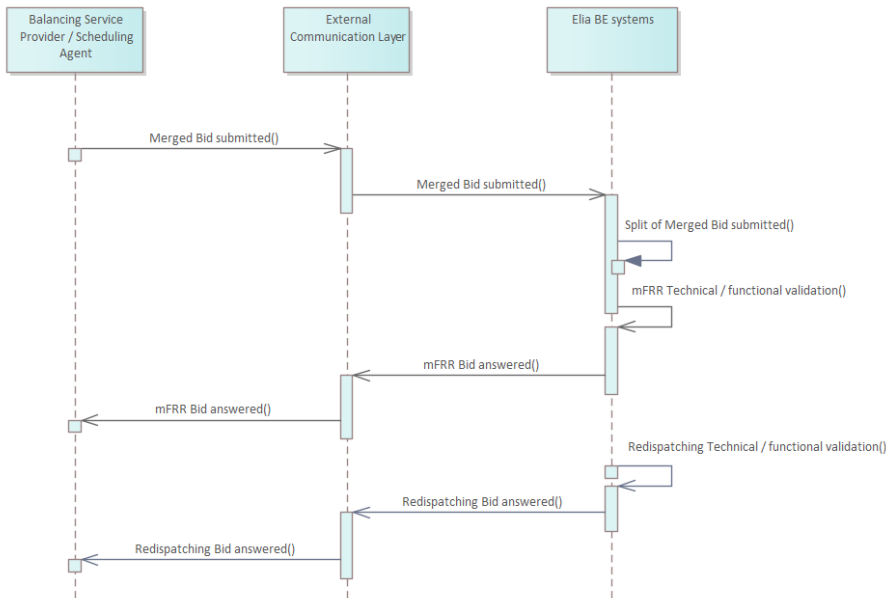

The BSP/SA will send a Merged bid message asynchronously to Elia. The External Communication Layer will treat the message in an asynchronous manner and will reply to it with the result of the validation done in the Elia backend systems.

11.2.2 Queue information

This table contains the exchange to send messages in a normal scenario:

Message Type	Description	Sender	Receiver	Queue/Exchange
Merged Energy Bid Submitted	Submission of new bid or bid update	BSP/SA	Elia	mFRRRedispatchingMergedEnergyBidSubmitted.In.Exch

The answer to the Merged Energy Bid message is provided on the mFRR Bid Answered queue and Redispatching Bid Answered queue respectively. There is no dedicated answer queue for the Merged Energy Bid messages.

Error queues

This table contains the queue to receive messages only in case of error:

Message Type	Sender	Receiver	Queue/Exchange
Merged Bid Submitted	Elia	BSP/SA	mFRRRedispatchingMergedEnergyBidSubmitted.[TargetMarketPartyID].ErrorQ

11.2.3 Bid submitted message

11.2.3.1 Message granularity

For bidding, the granularity is set at the **Providing Group** and the **bid execution date** level. Meaning that for each combination of these objects, we expect exactly one single message per sent version.

This means that the providing group used in the Merged Energy Bid message is the same for the mFRR Energy Bid message and the Redispatching Energy Bid message after the split.

11.2.3.2 Message timeframe

To allow the right context, the timeframe in which Merged Energy bids can be submitted is described here. Note however that the Merged Energy Bids are not processed as such. The Merged Energy Bid message is split into an mFRR Energy Bid message and a Redispatching Energy Bid message and these are then processed separately and independently. This means that the timing of each part is validated separately and independently. Please refer to the validations on timelines for each product in the sections above (9.5 [Submitting redispatching bids](#), and 10.3 Submission of mFRR Energy Bids).

Merged Energy Bids can be submitted between D-7 and BE GCT. Please note that:

- The standstill period is only relevant for Redispatching Energy Bids;
- The GCT for mFRR Energy Bids (i.e. the BE GCT) and the GCT for Redispatching Energy Bids are different.

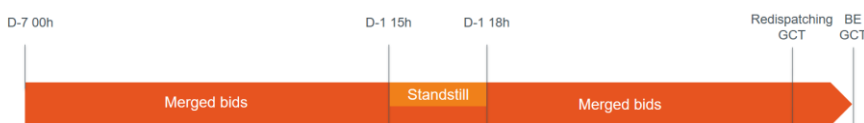

Deleted: Submitting redispatching bids

11.2.3.3 Message description

A [ReserveBid_MarketDocument](#) is the message that must be used in order to submit the bids.

Optional fields of the MarketDocument that are not described in this chapter cannot be used.

ReserveBid_MarketDocument (exactly one element per message)			Values used after split	
Field	Mandatory	Description	mFRR	RD
mRID	Y	Unique identification of the MarketDocument (UUID)	Same for both	
revisionNumber	Y	Version number for the market document	Same for both	
type	Y	Type of MarketDocument. Fixed value: A24 = Bid Document	Same for both	
process.processType	Y	Code for type of process: A47A41	A47	A41

		Remark: Value provided in this field is not validated		
sender_MarketParticipant.mRID	Y	The identification of the sender (EIC code)	Same for both	
sender_MarketParticipant.marketRole.type	Y	The role code associated with the sender: A46Z02 Remark: Value provided in this field is not validated	A46	Z02
receiver_MarketParticipant.mRID	Y	The identification of the receiver (EIC code). Fixed value: 10X1001A1001A094 = Elia	Same for both	
receiver_MarketParticipant.marketRole.type	Y	The role code associated with the receiver: A04 = System Operator	Same for both	
createdDateTime	Y	The date and time of the creation of the document	Same for both	
reserveBid_Period.timeInterval	Y	The begin and end date and time of the period covered by the document	Same for both	
Bid_TimeSeries	Y	Bid timeseries associated to the market document. It must contain at least one element.	All bid timeseries provided in the Merged Energy Bid are used in the mFRR Energy Bid	Only timeseries where auction.mRID = Z01 are used in the Redispatching Energy Bid message If there are no such timeseries, then no Redispatching Energy Bids are created

Bid_TimeSeries			Values used after split	
Field	Mandatory	Description	mFRR	RD
mRID	Y	Unique identification of the bid timeseries within the MarketDocument	Same for both	
status	N	Only used in case of cancellation, with the following code: A09 = Cancelled	Same for both	

auction.mRID	Y	Possible values : Z01 = Non-contracted Z02 = Contracted	Used	Not used
businessType	Y	Identifies the trading nature of the timeseries: B74 = Offer Remark: Value provided in this field is not validated	Used	Used If the value Z11 (prequalification bid) is used the Redispatching Energy Bid message will be rejected
bidGroupIid	Y	The unique identification used to identify associated bids with each other into a Bid Group. This identification is defined by the sender and must be unique	Same for both	
multipartBidIdentification	N	The identification used to associate parent child bids. If the bid is not part of parent child group then the attribute is not used. This identification is defined by the sender and must be unique	Same for both	
exclusiveBidsIdentification	N	The identification used to associate exclusive bids. If the bid is not exclusive then the attribute is not used. This identification is defined by the sender and must be unique	Used If multiple elements are found the mFRR Energy Bid message will be rejected	Used
ProvidingGroup	Y	The Delivery Points that form the Providing Group to which these bids are related. The list should contain at least one element.	Same for both	

BidGroup	N	The specific Delivery Points to which the Bid Group is related.	Same for both	
flowDirection.direction	Y	The coded identification of the direction of energy flow. A01 = UP A02 = DOWN	Same for both	
activation_ConstraintDuration.duration	N	Full-Activation Time (FAT) (in min) necessary to reach the offered maximum bid volume For Redispatching Energy Bids a fixed value of 12,5 minutes is used.	Not used	Fixed value: 12,5 minutes <u>Remark:</u> The value submitted in the Merged Energy Bid message is not imported
maximum_ConstraintDuration.duration	N	Maximum Activation time (MAT) (in min) during which the maximum bid volume can be activated If no value is provided, then there is no limitation on the maximum constraint duration.	Same for both	
minimum_ConstraintDuration.duration	N	Minimum Activation time (MIT) (in min) during which the bid needs to be activated If no value is provided, then there is no minimum activation time.	Not used	Used
neutralization_Duration.duration	N	If the activation of a bid is not prolonged, the Neutralization Time (NT) (in min) is the time during which the bid volume cannot be activated after a previous activation If no value is provided, then there is no neutralization time.	Used	Not used
Linked_BidTimeSeries	N	List of conditionally linked bid timeseries.	Same for both	

		There is a maximum of 6 elements allowed in this list.	
Period	Y	List of periods associated to the timeseries. It should contain at least one element.	Same for both

Period			Values used after split	
Field	Mandatory	Description	mFRR	RD
timeInterval	Y	The start and end date and time of the period	Same for both	
resolution	Y	PT15M = 15 minutes	Same for both	
point	Y	List of points associated to the period. It should contain as many point as needed to complete the period.	Same for both	

Point			Values used after split	
Field	Mandatory	Description	mFRR	RD
position	Y	The interval number defining which position in the timeseries is indicated. It must start at 1.	Same for both	
quantity.quantity	Y	The maximum Bid Volume offered in the bid	Same for both	
minimum_Quantity.quantity	N	The minimum volume that must be activated for this bid. If no value is provided, a default of 0 MW will be considered.	Same for both	
energy_Price.amount	Y	Price in euro for each offered MWh	Used	Not used
energy_SecondaryPrice.amount	Y	Price in euro for each offered MWh	Not used	Used
maximum_EnergyLevel.energy	N	The Maximum Energy Level (MEL) indicates the maximum remaining energy for the Providing Group. If no value is provided, no limitation will be considered.	Used	Used
standard_MarketProduct.marketProductType	N	Possible values:	Used	Not used

		A05 = Standard mFRR product eligible for scheduled activation only A07 = Standard mFRR product eligible for scheduled and direct activation If no value is provided, a default value of A07 will be used.		
PointGroup	N	The specific delivery points to which the interval of this bid is related.	Same for both	
Reason	N	List of reasons associated to the point. Maximum one element.	Same for both	

Linked_BidTimeSeries			Values used after split	
Field	Mandatory	Description	mFRR	RD
mRID	Y	The bidGroupid to which the conditional link refers to	Same for both	
status	Y	The condition of the conditional linked bid: A55 = Not available if linked bid activated A56 = Not available if linked bid rejected A67 = Available if linked bid activated A68 = Available if linked bid rejected	Same for both	
level	Y	The level determines the position of the bid within the linked Bid Group with respect to the current bid: 1 = refers to t-1 of the linked bid with respect to the current position of this bid 2 = refers to t-2 of the linked bid with respect to the current position of this bid	Same for both	

RegisteredResource			Values used after split	
Field	Mandatory	Description	mFRR	RD
mRID	Y	EAN code of a DeliveryPoint	Same for both	

Reason			Values used after split	
Field	Mandatory	Description	mFRR	RD
code	Y	<p>Y24 = Forced Outage The concerned contracted or non-contracted mFRR or Redispatching Energy Bid is impacted by a Forced Outage.</p> <p>B46 = Internal Congestion (DP activated for redispatching) A Redispatching Energy Bid, provided by a Delivery Point Dpsu also included in the concerned non-contracted mFRR Energy Bid, is activated by ELIA.</p> <p>Y25 = Other The concerned non-contracted mFRR Energy Bid contains (a) Delivery Point(s) that is (are) operated to balance the perimeter of the concerned BRP (i.e. for self-balancing), to balance the ELIA LFC Block (i.e. for reactive balancing) or to perform a trade on the intraday market.</p>	Used	Used If other reason codes than Y24 are found, the Redispatching Energy Bid message will be rejected

timeInterval			Values used after split	
Field	Mandatory	Description	mFRR	RD
start	Y	The start date and time of the interval	Same for both	
end	Y	The end date and time of the interval	Same for both	

11.2.4 Validation of a bid submitted message

This information flow will be subject to generic validation rule GEN_001. This validation rule is described in the following section of this document: [Validation rules description](#).

In order for the Merged Energy Bid message to be split into an mFRR Energy Bid message and a Redispatching Energy Bid message, the message format must be correct. If the message format is not correct, the message will be rejected and transferred to the error queue.

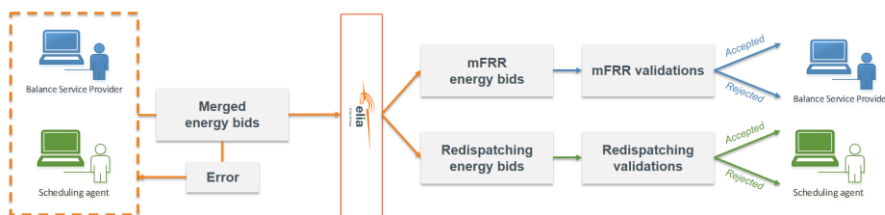

Field Code Changed

No other validation rules are applied on the Merged Energy Bid message. The Merged Energy bid message is split into an mFRR Energy Bid message and a Redispatching Energy Bid message. After this split, the validation rules for mFRR Energy Bid messages and Redispatching Energy Bid message are applied on the mFRR part and Redispatching part respectively.

11.2.5 Bid answered message

The answer to the Merged Energy Bid message is provided via the mFRR Bid Answered message for mFRR Energy Bids and via the Redispatching Bid Answered message for Redispatching Energy Bids. There is no dedicated answer message for the Merged Energy Bid messages.

12 Validation rules description

This chapter includes the generic validation rules that will be applied to all messages as well as the descriptions of the validation rules that are referenced in the validation rule sections of the respective guides.

12.1 Generic

All MarketDocuments submitted to Elia are subject to a technical validation of the message.

In case one of the rules for technical validation fails, the message will be rejected and the answer message will indicate the code of the error and a descriptive text inside a Reason object.

The values for the Reason code are fixed and described in this guide. However, the descriptive text can be changed at any moment by Elia.

Example:

```

"Reason": [
  {
    "code": "A51",
    "text": "A higher version of the message already exists"
  }
]
    
```

This chapter describes the technical validation rules that apply to all MarketDocuments described in the subsequent sections, and their corresponding codes.

The Reason object can either be associated to the MarketDocument or to a specific timeseries.

Note: Level indicates if the rule applies to the whole MarketDocument or to the timeseries individually.

ID	Validation Rule	Reply Status	Reason Code	Level
GEN_001	Message format must be correct	Reject message	Not applicable. Message will be transferred to error queue	Not applicable
GEN_002	Mandatory fields must be present	Reject message	A69	MarketDocument
GEN_003	Data formats must be respected	Reject message	Y29	MarketDocument
GEN_004	Value of fields must be known	Reject message	Y28	MarketDocument
GEN_005	Time interval start date and time must be smaller than the end date and time	Reject message	Y97	MarketDocument Timeseries
GEN_006	The timeseries mRID must be unique within the MarketDocument	Reject message	A55	Timeseries
GEN_007	Timeseries period must fall within the MarketDocument period	Reject message	A81	Timeseries
GEN_008	No overlap of periods allowed for the same timeseries within the message	Reject message	Y96	Timeseries

GEN_009	The revisionNumber of the incoming message must be greater than an existing revisionNumber for the same MarketDocument mRID	Reject message	A51	MarketDocument
GEN_010	The number of points must match with the time interval of the period	Reject message	A49	Timeseries
GEN_011	The position of a point within a period must be correct	Reject message	Y95	Timeseries
GEN_012	Business key must be known by Elia <ul style="list-style-type: none"> - Delivery point - Sender company 	Reject message	A05	MarketDocument
GEN_013	sender_MarketParticipant.mRID must contain the EIC code of the Market Party linked to the user-id of the message	Reject message	A78	MarketDocument
GEN_014	A MarketDocument with revisionNumber n must contain all timeseries contained in revision n-1	Reject message	A52	MarketDocument
GEN_015	MarketDocument mRID must be unique	Reject message	Y94	MarketDocument
GEN_016	Field cannot be used	Reject message	Y93	MarketDocument
GEN_017	MarketDocuments provided on message queues must be processed within a specific time window	Reject message	Y06	MarketDocument
GEN_018	Market Document waiting for confirmation becomes obsolete due to valid intermediary update	Reject message	X97	MarketDocument

GEN_001 – Message format must be correct

The file format of the message provided on the message queue must be correct. If the message does not have the correct file format, the message will be rejected and transferred to the corresponding error queue.

GEN_002 – Mandatory fields must be present

The message must contain a value for all mandatory fields. The mandatory fields per message can be found in the message specifications. If a value is missing for a mandatory field in the message, the message will be rejected.

GEN_003 – Data formats must be respected

The data format of the fields in the message must be respected. The data format per field can be found in the message specifications. If a message contains a value of an incorrect data format for a field, the message will be rejected.

GEN_004 – Value of fields must be known

The value of the fields in the message must be known by the receiver. The allowed values per field can be found in the message specifications. If a message contains a value which is not known to the receiver, the message will be rejected.

Example:

For a field that has only two possible values: “A60” or “A61”.

This rule will check that the value received for the field is either “A60” or “A61”.

GEN_005 – Time interval start date and time must be smaller than the end date and time

In the message a time interval can be specified:

- On the MarketDocument level
- For every period within the message

For both of these time intervals the start date and time must be smaller than the end date and time. If the start date and time is greater than or equal to the end date and time, the message will be rejected.

GEN_006 – The timeseries mRID must be unique within the MarketDocument

For every timeseries in a message a unique mRID must be provided. This mRID must be unique within the message. If a message contains two or more timeseries with the same mRID, the message will be rejected.

GEN_007 – Timeseries period interval must fall within the MarketDocument period interval

In the message a time interval can be specified:

- On the MarketDocument level
- For every period within the message

The time interval specified on a timeseries period must fall within the time interval specified on the MarketDocument. This means that for every period:

- the start date and time of the period time interval must be greater than or equal to the start date and time of the MarketDocument time interval
AND that
- The end date and time of the period time interval must be smaller than or equal to the end date and time of the MarketDocument time interval

If the time interval of a period does not fall within the time interval of the MarketDocument, the message will be rejected.

GEN_008 – No overlap of periods allowed for the same timeseries within the message

A timeseries within the message contains one or multiple periods. For every period a time interval is specified. The time intervals of periods within the same timeseries cannot overlap. If there are periods with overlapping time intervals within the same timeseries, the message is rejected.

Example:

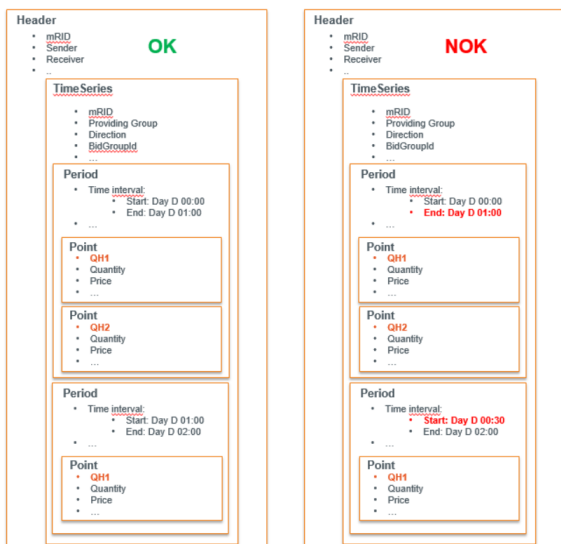

GEN_009 – The revisionNumber of the incoming message must be greater than an existing revisionNumber for the same MarketDocument mRID

For messages updates can be submitted. When submitting an update of a message the same MarketDocument mRID must be used and the revisionNumber must be increased. The message with the greatest revisionNumber is assumed to be latest and most up to date version of the message.

If a message is received where a greater revisionNumber for the same MarketDocument mRID already exists, the message will be rejected.

GEN_010 – The number of points must match with the time interval of the period

A time interval is specified for every period in the message. The period must contain a point for every quarter hour in the period, if not the message will be rejected.

Example:

- A period has a time interval of 20:15 to 21:30 on day D
- This means that the duration of this time interval is 75 minutes or 5 quarters
 - o This means that there must be 5 positions in the period

If message contains too few or too many points for the concerned period, the message will be rejected

A full day must account for 96 quarter hours. There is an exception for the days when the change to summer or winter time takes place.

- The last Sunday of October must account for 100 quarter hours for a full day

⋮ *The last Sunday of March must account for 92 quarter hours for a full day*

Example 2: summer time to winter time in Belgium in 2020.

Since all dates must be in UTC, a period from midnight until 3am (local time) for the day 2020-10-25, corresponds to the following period in UTC: 2020-10-24T22:00Z until 2020-10-25T02:00Z.

This means that 16 positions are expected for that period.

Example 3: winter time to summer time in Belgium in 2020.

Since all dates must be in UTC, a period from midnight until 4 am (local time) for the day 2020-03-29, corresponds to the following period in UTC: 2020-03-28T23:00Z until 2020-03-29T02:00Z.

This means that 12 positions are expected for that period.

GEN_011 – The position of a point within a period must be correct

A position indicates the position of a period related to the time interval of the period. Every position is numbered starting at one for the first point and is incremented by one for every subsequent point within the period.

For example:

- A period has time interval of 20:15 to 21:30 on date x
- As indicated above, 5 positions are expected for this period
- This means that position values between 1 and 5 are allowed.

Position	Description	Time interval
1	First quarter	20:15 – 20:30
2	Second quarter	20:30 – 20:45
3	Third quarter	20:45 – 21:00
4	Fourth quarter	21:00 – 21:15
5	Fifth quarter	21:15 – 21:30

If the message contains incorrect position values relative to the period time interval, the message will be rejected.

GEN_012 – Business key must be known by Elia

The value of eventual business keys in the message must be known by Elia. The message specifications indicate for which fields in the message business keys must be used. If a message contains a business key which is not known by Elia, the message will be rejected.

The following business keys are identified:

- Delivery point
- Sender market participant

GEN_013 – sender_MarketParticipant.mRID must contain the EIC code of the Market Party linked to the user-id of the message

Every Market Party will have a dedicated user to connect to the External Communication Layer. Every message sent by a Market Party will include a user-id in the header of the message.

Elia will control that the user-id corresponds to the Market Party EIC code specified in the MarketDocument, in field sender_MarketParticipant.mRID.

GEN_014 – A MarketDocument with revisionNumber n must contain all timeseries contained in revision n-1

A MarketDocument with revisionNumber “n” must contain all timeseries contained in the previous accepted revisionNumber, unless the entire period of a timeseries block falls in the past.

Example:

MarketDocument A with revisionNumber = 1 contains time series A, B and C.

MarketDocument A with revisionNumber = 2 must contain A, B, C and any other additional timeseries.

Example 2:

MarketDocument A with revisionNumber = 1 is created at 10:47 and contains a timeseries B, with a Period that ends at 12:15.

MarketDocument A with revisionNumber = 2 is created at 11:32, it must contain timeseries B.

MarketDocument A with revisionNumber = 3 is created at 12:23, it does not require the resent of timeSeries B, because the period of the timeseries has ended.

GEN_015 – MarketDocument mRID must be unique

MarketDocument mRID must be unique.

The same mRID can only be used (and must be used) when submitting a new revisionNumber of the same MarketDocument.

GEN_016 – Field cannot be used

Fields of the MarketDocument that are not applicable for a specific message cannot be used or should include a null value.

GEN_017 – MarketDocuments provided on message queues must be processed within a specific time window

When MarketDocuments are provided to Elia, the time of posting the MarketDocument on the message queue will be compared with the time of processing the message in the back-end application. If the processing of the message cannot be executed within a specific time window, the MarketDocument will be rejected.

GEN_018 – Market Document waiting for confirmation becomes obsolete due to valid intermediary update

Some validation rules in the different guides require an extended confirmation period between reception and validation or rejection of a Market Document for specific reasons (ex. Need for manual validation by Elia).

Following states in confirmation messages can be expected for these cases:

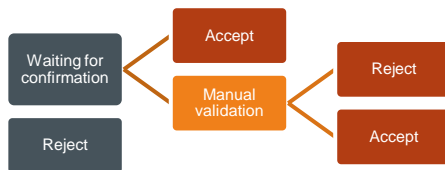

When a message is technically or functionally rejected, this will immediately be confirmed to the Market Party. When it is functionally correct, it will come into the waiting for confirmation state. Subsequently it gets either accepted by a certain trigger (ex. End of the standstill period) or needs to undergo a manual validation process which can still end up in a Reject or an Accept as a result.

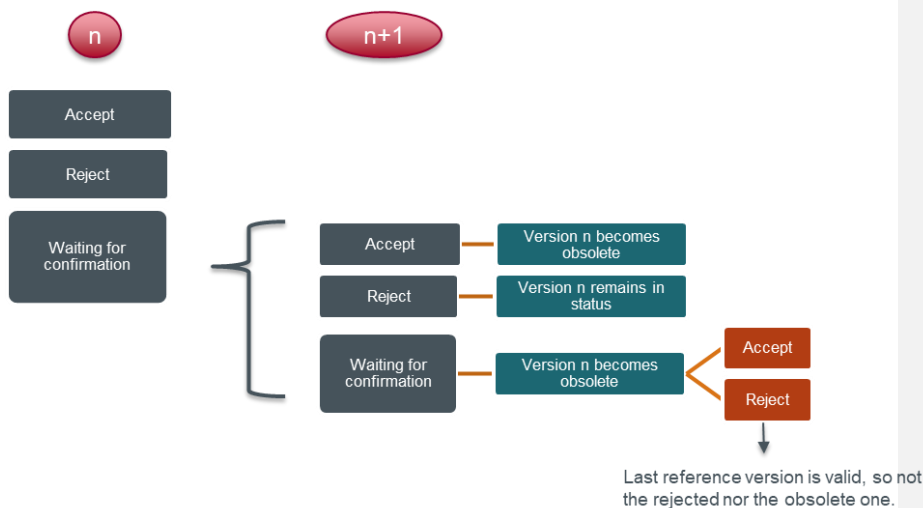

When an update (n+1) of that Market Document is sent while the latest known valid version (n) was still in a “Waiting for confirmation” status, the following scenarios are possible

- Update n+1 is accepted, meaning that version n becomes obsolete. A confirmation message will be sent for
 - Version n : a reject with the code of the here described rule
 - Version n+1 : an accept

- Update n+1 is rejected, meaning that version n remains the last valid reference version as if no update was sent. A confirmation message will be sent for
 - Version n+1 : a reject with the code of the rule triggering the reject
- Update n+1 is in waiting for confirmation, meaning that version n becomes obsolete. A confirmation message will be sent for
 - Version n : a reject with the code of the here described rule
 - Version n+1 : a waiting for confirmation with the code of the rule triggering a waiting for confirmation reason

Note that in the last scenario, if a reject of version n+1 would subsequently take place, this would mean that version n and version n+1 are both rejected and the last accepted version becomes the last reference version of the Market Document.

Internal error

In exceptional cases, Elia could reject a message due to an internal error.

Reply Status	Reason Code	Level
Reject message	999	MarketDocument

12.2 Outage Planning

OPL_001 – Planned unavailability submitted before unavailability start date’s related ready-to-run process

Planned unavailabilities (Planned outage or Testing) should be submitted after the end of the unavailability start date’s related ready-to-run process.

	W-1							W 0						
	Monday	Tuesday (ready-to-run GCT at 18:00 for W0)	Wednesday	Thursday	Friday	Saturday	Sunday	Monday	Tuesday	Wednesday	Thursday	Friday	Saturday	Sunday
Unavailability event starting in week 0 sent on X	x	x	x	x	x	x	x	x	x	x	x	x	x	x
	Before 18:00 – Rejected		Waiting for confirmation (needs manual validation from Elia)											
	Rejected		Waiting for confirmation (needs manual validation from Elia)											
	After 18:00 – Waiting for confirmation (needs manual validation from Elia)		Waiting for confirmation (needs manual validation from Elia)											

- Deleted:** The unavailability start date should fall between D-1 and D+12 for new planned unavailabilities
- Formatted:** Font: Bold
- Formatted:** Font: Bold
- Formatted:** Normal
- Formatted:** Font: (Default) +Body (Calibri), Font color: Auto

OPL_002 – The unavailability start date should fall before current date + 12 for updates of unavailabilities

In the MarketDocument the timeInterval is specified. This timeInterval represents the unavailability period for the unavailability indicated in the message. The following is imposed for planned unavailabilities (Planned outage or Testing):

$$\text{Unavailability period start date} \leq \text{Current date} + 12 \text{ days}$$

OPL_003 – The unavailability end date should lie after D-1

In the MarketDocument the timeInterval is specified. This timeInterval represents the unavailability period for the unavailability indicated in the message. The following is imposed:

- Deleted:** In the MarketDocument the timeInterval is specified. This timeInterval represents the unavailability period for the unavailability indicated in the message. The following is imposed for planned unavailabilities (Planned outage or Testing): ¶

Current date – 1 day ≤ Unavailability period end date

OPL_004 – The unavailability period of the MarketDocument must be the same as the period of the unavailability event

The MarketDocument timeInterval must be equal to the Timeseries timeInterval as we only allow one unavailability event per MarketDocument. This does not apply when the unavailabilities from the Ready-to-Run procedure are withdrawn as described in the [Updates and withdrawals](#) section of the OPA Guide as the Timeseries block is not used in that case.

Field Code Changed

OPL_005 – The Delivery Point must be included in an OPA contract valid for the availability period for this Outage Planning Agent

The Outage Planning Agent must have the Delivery Point included in a valid Outage Planning contract for the entire unavailability period.

OPL_006 – Unavailability event periods cannot overlap across Market Documents

As unavailabilities cannot have overlapping periods, it is not allowed to have overlapping periods for **different** Market Documents (Market Documents that are not an update, meaning they have a different Market Document mRID).

OPL_007 – Planned unavailabilities need manual verification

When a planned unavailability (Planned outage or Testing) is created or updated, this requires manual verification by Elia. For Forced Outages this is not the case.

OPL_008 – The maximum available capacity should always be expressed in absolute values

The maximum available capacity in MW should always be expressed in absolute value.

OPL_009 – The unavailability start date should fall between D-1 and next QH after real time for new forced outages

In the MarketDocument the timeInterval is specified. This timeInterval represents the unavailability period for the unavailability indicated in the message. The following is imposed:

Current date – 1 day ≤ Unavailability period start date ≤ Next QH after real time

OPL_010 – The updated start date of a forced outage should lie on the same day than the start date of the original forced outage

In the MarketDocument the timeInterval is specified. This timeInterval represents the unavailability period for the unavailability indicated in the message. The following is imposed:

Current forced outage start day = Updated forced outage start day

OPL_011 – Forced outage updates need manual verification when updated end date lies before current end date

When a forced outage is updated, this requires manual verification by Elia whenever the updated end date of the forced outage lies before the current forced outage's end date.

Current forced outage end date > Updated forced outage end date

12.3 Scheduling

SCH_001 – Redispatching GCT must be respected

The required scheduling timing depends on the timeframe in which the message is sent. All messages that are not received within D – 7 and D – 45 minutes will be rejected. In case of a Forced Outage, the schedule can be updated until realtime for which the corresponding Reason field must be set.

SCH_002 – Scheduled power must be within technical capacity

It is not allowed to provide scheduled values that lie below the minimum technical capacity or maximum capacity of the delivery point, unless in case of a startup or shutdown scenario. In the case we have a startup (0 to above Pmin) or a shutdown (from above Pmin to 0), this needs to be completed within a maximum of two execution days.

When a start of stop is detected, the sequence of values must be in the same direction or at least the same value. This check is done until we reach the completion of a startup or shutdown or the execution day ends.

This check is not activated during activations.

SCH_003 – The Delivery Point must be included in an SA contract valid on the execution date for this Scheduling Agent

The Scheduling Agent must have a valid scheduling contract right for the delivery point used in the message on schedule execution date.

SCH_004 – The MW schedule must be expressed in one fraction digit

The power precision of the MW schedule must be expressed with one fraction digit (0.X).

SCH_005 – A schedule cannot be updated in the opposite direction of a redispatching activation on the same period

If a schedule update is requested on a Delivery Point that is included in a RD Energy bid which is activated in the opposite direction with respect to the requested schedule update, then the schedule update is automatically rejected.

The example below illustrates an upward RD activation between 22:00 and 23:45 (first case) and a downward RD activation between 22:00 and 23:45 (second case). In the first case only an upward schedule is allowed and in the second case only a downward schedule.

	21:30	21:45	22:00	22:15	22:30	22:45	23:00	23:15	23:30	23:45
RD activation UP			40	40	40	40	40	40	40	40
Active valid schedule	100	100	100	100	100	100	100	100	100	100
New schedule ex 1	100	80	80	80	80	80	80	80	100	100
New schedule ex 2	120	120	120	120	120	120	120	120	120	120
RD activation DOWN			40	40	40	40	40	40	40	40
Active valid schedule	100	100	100	100	100	100	100	100	100	100
New schedule ex 1	100	100	80	80	80	80	80	80	100	100
New schedule ex 2	120	120	120	120	120	120	120	120	120	120

SCH_006 – Incremental update requested during a storm is subject to manual validation

In case the scheduled power is increased during the period of a storm event, this rule will initiate a request for manual validation by Elia.

The example below illustrates a storm event taking place between 19h30 and 22h30. Each schedule update request is subject to manual validation in case the scheduled power of at least one of the quarter hours is increased on the period of a storm event.

	19:30	19:45	20:00	20:15	20:30	20:45	21:00	21:15	21:30	21:45	22:00	22:15	22:30	22:45	23:00	23:15	23:30
Storm																	
Active valid schedule	50	50	50	50	50	50	50	50	0	0	0	0	0	0	0	0	0
New schedule ex 1	0	0	0	0	0	0	0	0	0	0	0	0	0	0	0	0	0
New schedule ex 2	0	0	0	0	0	0	0	0	0	0	50	50	50	50	50	50	50

SCH_007 – Update requested in violation with Must Run or May Not Run Status is not allowed

If a Must Run or May Not Run status exists on the execution date and a schedule update message contains an update violating this status, then the message will be rejected.

The example below illustrates a Must Run obligation of min 20 MW between 22:00 and 23:45 (first case) and a May Not Run obligation above 40 MW between 22:00 and 23:45 (second case).

	21:30	21:45	22:00	22:15	22:30	22:45	23:00	23:15	23:30	23:45
Must Run			20	20	20	20	20	20	20	20
Active valid schedule	100	100	100	100	100	100	100	100	100	100
New schedule ex 1	100	80	80	80	50	50	50	20	10	10
New schedule ex 2	120	120	120	120	120	100	100	80	50	50
May not run			40	40	40	40	40	40	40	40
Active valid schedule	0	0	0	0	0	0	0	0	0	0
New schedule ex 1	100	100	0	0	0	0	0	0	10	10
New schedule ex 2	120	120	0	0	0	0	0	0	30	50

SCH_008 – The MarketDocument time period must exactly cover one day

In the message a time interval is specified on the message level. This time interval must exactly cover one full calendar day. In the message the date and time fields are expressed in UTC time.

In local time this means that:

- The start date and time for the message on day D is expected to be 'date day D' 00:00:00
- The end date and time for the message on day D is expected to be 'date day D+1' 00:00:00

In UTC time this means that:

In the period where summer time applies (from the last Sunday in March to the last Sunday of October):

- The start date and time for the message on day D is expected to be 'date day D' 22:00:00
- The end date and time for the message on day D is expected to be 'date day D+1' 22:00:00

In the period where winter time applies (from the last Sunday of October to the last Sunday in March):

- The start date and time for the message on day D is expected to be 'date day D' 23:00:00
- The end date and time for the message on day D is expected to be 'date day D+1' 23:00:00

If the message time interval covers less or more than one full day, the message will be rejected.

SCH_009 – The schedule is received within the standstill period

When a schedule is received within the standstill period it will not be confirmed immediately. On the moment the standstill period ends, a second reply with the respective confirmation will be sent. Automatic rejects on the messages received within the standstill period will be sent immediately, in which case no 'Waiting for confirmation' reply will be communicated.

SCH_010 – A schedule must always cover a complete calendar day

A schedule should always cover a complete calendar day, meaning that any version sent before intraday should contain 96 quarter hours (winter-summer (92) summer-winter (100)). When updating a schedule in intraday, the past is ignored so it is expected to receive at least from the ongoing quarter hour until end of day (as described in chapter 4.3).

SCH_011 – Schedule reverted due to inconsistency with Redispatching bid

Elia will perform coherency control between schedules and Redispatching bids. The schedules that are detected to be incoherent will be verified manually by the operator. The operator subsequently has the right to revert the schedule (meaning a reject is sent for an already accepted schedule), when it is inconsistent with the corresponding Redispatching bid. The last valid schedule that was active before the reverted schedule will become active again.

SCH_012 – The Delivery Point must be included in a BSP contract valid on the execution date for this Balancing Service Provider

The Balancing Service Provider must have a valid contract right for the delivery point used in the message on schedule execution date.

SCH_013 – The schedule update can only cover the quarter hours between Redispatching GCT and the start of the current Qh + 5 minutes

The schedule update can only contain quarter hours for which the Redispatching GCT has been passed and quarter hours for which the start + 5 minutes is not yet passed. This means it is only possible to update quarter hours within the specific timeframe of after Redispatching GCT and T+5. If the schedule update contains quarter hours which fall before Redispatching GCT or for which start has been passed with more than 5 minutes, the schedule message will be rejected.

The example below illustrates the quarter hours which can be updated with a green 'X' for a given current time.

	RD GCT	20:45	21:00	21:15	21:30	21:45	22:00	22:15	22:30	22:45	23:00
Current time	Qh	21:30	21:45	22:00	22:15	22:30	22:45	23:00	23:15	23:30	23:45
22:04		-	-	X	X	X	X	-	-	-	-
22:27		-	-	-	-	X	X	X	-	-	-

SCH_014 – Schedule updates in the direction of a medium or high CRI level are not allowed

It is not allowed to update the schedule in the direction of a medium or high CRI level. If a schedule update is submitted for a Delivery Point located in an electrical zone with a medium or high CRI level and the update goes in the direction CRI level, the message will be rejected.

The example below illustrates the updates which are allowed for a given CRI level, for a given direction.

	21:30	21:45	22:00	22:15	22:30	22:45	23:00	23:15	23:30	23:45
Active valid schedule	50	50	50	50	50	50	50	50	50	50
CRI High upwards										
New schedule ex 1	20	20	60	60						
CRI Medium downwards										
New schedule ex2							60	60	40	40

SCH_015 – Incremental update requested during a storm is not allowed

In case the scheduled update message includes an update where the power is increased during the period of a storm event, the message will be rejected.

The example below illustrates a storm event taking place between 19h30 and 22h30. Each schedule update message is rejected in case the scheduled power of at least one of the quarter hours is increased on the period of a storm event.

	19:30	19:45	20:00	20:15	20:30	20:45	21:00	21:15	21:30	21:45	22:00	22:15	22:30	22:45	23:00	23:15	23:30
Storm																	
Active valid schedule	50	50	50	50	50	50	50	50	0	0	0	0	0	0	0	0	0
New schedule ex 1	0	0	0	0	0	0	0	0	0	0	0	0	0	0	0	0	0
New schedule ex 2	0	0	0	0	0	0	0	0	0	0	50	50	50	50	50	50	50

SCH_016 – Schedule updates for mFRR baseline are not allowed in case no valid schedule has been submitted by the Scheduling Agent

In case that no valid schedule has been submitted by the Scheduling agent for the Delivery Point, all schedule updates for mFRR baseline for that Delivery Point will be rejected.

SCH_017 – Schedule updates for mFRR baseline are not allowed for quarter hours where a (partial) FO has been submitted by the Scheduling Agent

For quarter hours where a full or partial forced outage has been submitted by the Scheduling agent for the Delivery Point, the schedule updates for mFRR baseline will be rejected. This means that it is not possible to submit a schedule update for mFRR baseline for quarter hours with a full or partial forced outage.

12.4 Bidding

BID_001 – The time period of the Energy Bid message must exactly cover one day

In the Energy Bid message a time interval is specified. This time interval must exactly cover one full day. In the Energy Bid message the date and time fields are expressed in UTC time.

In local time this means that:

- The start date and time for the message on day D is expected to be 'date day D' 00:00:00
- The end date and time for the message on day D is expected to be 'date day D+1' 00:00:00

In UTC time this means that:

In the period where summer time applies (from the last Sunday in March to the last Sunday of October):

- The start date and time for the message on day D is expected to be 'date day D-1' 22:00:00
- The end date and time for the message on day D is expected to be 'date day D' 22:00:00

In the period where winter time applies (from the last Sunday of October to the last Sunday in March):

- The start date and time for the message on day D is expected to be 'date day D-1' 23:00:00
- The end date and time for the message on day D is expected to be 'date day D' 23:00:00

If the message time interval covers less or more than one full day, the message will be rejected.

BID_002 – All timeseries within the same message must have the same Providing Group

For all timeseries provided within a message, the same Providing Group is expected. If within a message, there are timeseries with different Providing Groups, the message will be rejected.

BID_003 – The bid timeseries period interval must be a multiple of the resolution (default 15 min)

In the message a time interval is specified for every period within the message. This time interval must be a multiple of 15 minutes and these time intervals must be aligned with the MTUs.

This means that the start and end time of the period time interval in UTC is expected to be:

xx:00:00

- xx:15:00
- xx:30:00
- xx:45:00

If the time interval of a period is not a multiple of 15 minutes or is not aligned with the MTUs, the message will be rejected.

BID_004 – No overlap of periods allowed for timeseries of the same Bid Group

On each timeseries a Bid Group Id must be specified. This Bid Group Id is used to technically link timeseries within and across messages and is used for activations in combination with the period for the consecutive quarter hourly bids to activate. Timeseries which are linked together via a Bid Group Id cannot have overlapping periods making each bid per MTU unique. If there are periods with overlapping time intervals for timeseries which are linked, the message is rejected.

Example:

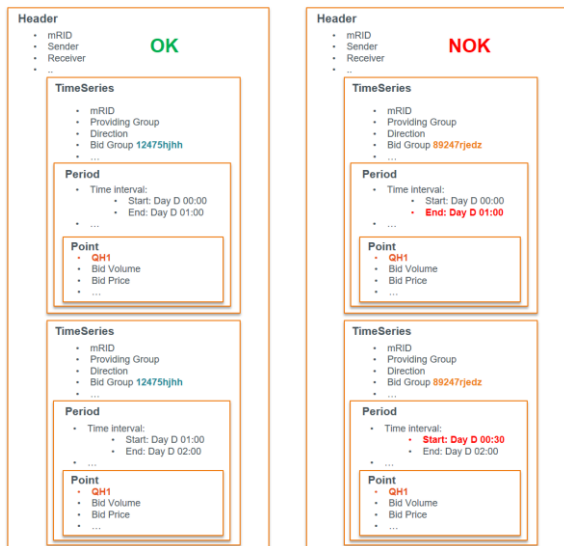

BID_005 – The same MarketDocument mRID must be used per Providing Group, per MarketDocument time interval

For a given MarketDocument time interval (= execution date) and a given Providing Group the same MarketDocument mRID must be used. This means that when providing updates for an execution date, for a Providing Group, the same MarketDocument mRID must be used and the revisionNumber must be incremented. When providing updates for a Providing Group on a given execution date, the MarketDocument mRID must remain unchanged.

If a message is received for another MarketDocument mRID for the same execution date and the same Providing Group, the message will be rejected.

Example:

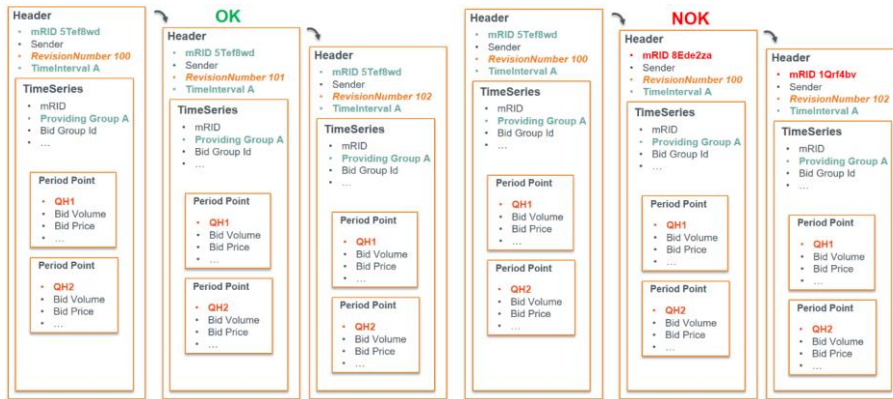

BID_006 – The Full-Activation Time (FAT) must be equal to 12,5 minutes or must be a multiple of 15 minutes

For redispaching bids the Full-Activation Time (FAT) can be provided in the timeseries. If no value is provided it is assumed that the FAT is 12,5 minutes. If a value is provided, this value must be greater than zero. This activation constraint duration must be:

- Either equal to 12,5 minutes
- Either a multiple of 15 minutes

If the FAT for redispaching Energy Bids is not equal to 12,5 minutes or a multiple of 15 minutes (except 0), the message will be rejected.

BID_007 – The Maximum Activation Time (MAT) must be a multiple of 15 minutes

For redispaching or mFRR Energy Bids, the Maximum Activation Time (MAT) can be provided in the timeseries. This MAT must be a multiple of 15 minutes and must be greater than zero. If the MAT for redispaching or mFRR Energy Bids is not a multiple of 15 minutes (except 0), the message will be rejected.

BID_008 – A Delivery Point can only be part of one Providing Group on one quarter hour on an execution date

For bidding, the message granularity is set at the Providing Group and the bid execution date level. Meaning that for each Providing Group, a message is sent per execution date.

On the bid timeseries in the message, the Providing Group is indicated. This Providing Group is a list with one or multiple Delivery Points. A Delivery Point can only be part of one Providing Group on one quarter hour on an execution date. If a Delivery Point is already included in another Providing Group for the same quarter hour on the same execution date, the message will be rejected.

Example:

OK			NOK		
Header <ul style="list-style-type: none"> mRID 4Esz2dK Sender RevisionNumber 100 TimeInterval A 	Header <ul style="list-style-type: none"> mRID 5Tef8wd Sender RevisionNumber 101 TimeInterval A 	Header <ul style="list-style-type: none"> mRID 5Tef8wd Sender RevisionNumber 102 TimeInterval A 	Header <ul style="list-style-type: none"> mRID 4Esz2dK Sender RevisionNumber 100 TimeInterval A 	Header <ul style="list-style-type: none"> mRID 5Tef8wd Sender RevisionNumber 101 TimeInterval A 	Header <ul style="list-style-type: none"> mRID 5Tef8wd Sender RevisionNumber 102 TimeInterval A
TimeSeries <ul style="list-style-type: none"> mRID Providing Group = DP A, DP B, DP C Bid Group Id ... 	TimeSeries <ul style="list-style-type: none"> mRID Providing Group = DP D, DP E, DP F Bid Group Id ... 	TimeSeries <ul style="list-style-type: none"> mRID Providing Group = DP D, DP E, DP F Bid Group Id ... 	TimeSeries <ul style="list-style-type: none"> mRID Providing Group = DP A, DP B, DP C Bid Group Id ... 	TimeSeries <ul style="list-style-type: none"> mRID Providing Group = DP A, DP E, DP F Bid Group Id ... 	TimeSeries <ul style="list-style-type: none"> mRID Providing Group = DP A, DP E, DP F Bid Group Id ...
Period Point <ul style="list-style-type: none"> QH1 Bid Volume Bid Price ... 	Period Point <ul style="list-style-type: none"> QH1 Bid Volume Bid Price ... 	Period Point <ul style="list-style-type: none"> QH1 Bid Volume Bid Price ... 	Period Point <ul style="list-style-type: none"> QH1 Bid Volume Bid Price ... 	Period Point <ul style="list-style-type: none"> QH1 Bid Volume Bid Price ... 	Period Point <ul style="list-style-type: none"> QH1 Bid Volume Bid Price ...
Period Point <ul style="list-style-type: none"> QH2 Bid Volume Bid Price ... 	Period Point <ul style="list-style-type: none"> QH2 Bid Volume Bid Price ... 	Period Point <ul style="list-style-type: none"> QH2 Bid Volume Bid Price ... 	Period Point <ul style="list-style-type: none"> QH2 Bid Volume Bid Price ... 	Period Point <ul style="list-style-type: none"> QH2 Bid Volume Bid Price ... 	Period Point <ul style="list-style-type: none"> QH2 Bid Volume Bid Price ...

There are no overlapping Providing Groups for the same quarter hours on the same execution date between the messages 4Esz2dk and 5Tef8wd.

DP A is in both message 4Esz2dk and 5Tef8wd for Qh1 and Qh2 on the same execution date. This is not allowed.

BID_009 – The Delivery Points of the Bid Group must belong to the Providing Group, if the Bid Group is defined

In the message it is possible to optionally specify the Delivery Points for a certain Bid Group. The Delivery Points which are specified for a Bid Group must belong to the Providing Group which is specified on the timeseries of the concerned point. If the Delivery Points of the Bid Group do not belong to the Providing Group of the message, the message will be rejected.

Example:

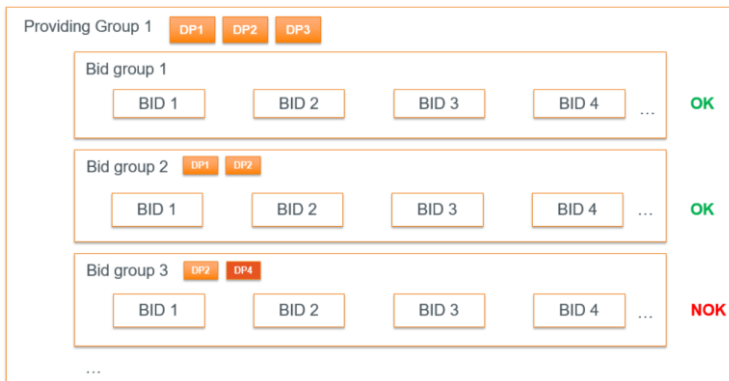

BID_010 – The Delivery Points in a specific quarter hour bid must belong to the Providing Group

In the message it is possible to optionally specify the Delivery Points for a specific quarter hour bid. The Delivery Points which are specified in a specific quarter hour bid must belong to the Providing

Group which is specified on the timeseries. If the Delivery points of the specific quarter hour bid do not belong to the Providing Group of the timeseries, the message will be rejected.

Example:



BID_011 – The Delivery Point must be included in a contract valid on the execution date for the bids

In the header of the MarketDocument the sender market participant is indicated. This sender market participant must have a valid contract with the receiver market participant which:

- Is valid for the MarketDocument time interval (= execution date)
- Is valid for the type of contract (mFRR, aFRR or scheduling (redispatching))
- The Delivery Points specified in the Providing Group of all timeseries must be included in the contract/pool of the Market Party

All of the above conditions must be met. If one of these conditions is not met, the message will be rejected.

BID_012 – If a DPSU Delivery Point is included in the Providing Group, then all other Delivery Points from that Providing Group must belong to the same Technical Facility

In every timeseries of the MarketDocument, a Providing Group is defined. This Providing Group lists the Delivery Points related to the bids. If a DP_{SU} is provided in the Providing Group, then all other Delivery Points from that Providing Group must belong to the same Technical Facility. If not all Delivery Points from that Providing Group belong to the same Technical Facility, the message will be rejected.

BID_013 – A DP_{PG} Delivery Point cannot be listed in an mFRR/aFRR bid or as an mFRR/aFRR backup Delivery Point for the same quarter hour on the same execution date

In the bid message the Delivery Points are specified. The DP_{PG} Delivery Points used in the mFRR/aFRR bid message cannot be listed in an aFRR/mFRR bid or as an aFRR/mFRR backup Delivery Point for the same quarter hour on the same execution date. If the bid message contains a DP_{PG} Delivery Point which is listed in an aFRR/mFRR bid or as an aFRR/mFRR backup Delivery Point for the same quarter hour on the same executed date, the message will be rejected.

BID_014 – A Delivery Point cannot be listed as a Prequalification Bid for the same execution date

In the bid message the Delivery Points are specified. The Delivery Points used in the bid message cannot be used in an already submitted Prequalification Bid on the same execution date. If the bid

message contains a Delivery Point which is used in an already submitted Prequalification Bid on the same execution date, the message will be rejected.

BID_015 – The Minimum Bid Volume must be greater than or equal to zero and must be smaller than or equal to the Bid Volume

The Minimum Bid Volume provided in a bid must be greater than or equal to zero. If the Minimum Bid Volume is negative for a bid, the message will be rejected.

The Minimum Bid Volume provided in a bid must be smaller than or equal to the Bid Volume provided in the concerned quarter hour bid. If the Minimum Bid Volume is greater than the Bid Volume for a quarter hour bid, the message will be rejected.

In a situation where the Bid Volume is updated to zero after Gate Closure Time, then the Minimum Bid Volume is allowed to be greater than the Bid Volume.

BID_016 – The Bid Volume must be greater than or equal to zero

The Bid Volume in a bid must be greater than or equal to zero. If the Bid Volume is negative for a bid, the message will be rejected.

BID_017 – For bids submitted before Gate Closure Time the Bid Volume must be greater than or equal to 1 MW

For bids submitted or updated before Gate Closure Time the Bid Volume must be greater than or equal to 1 MW. However in case of Forced Outage, a Bid Volume equal to zero is allowed before Gate Closure Time on the condition that it is a bid update. If a message which is submitted before Gate Closure Time, contains a Bid Volume which is smaller than 1 MW and the reason provided is not equal to Forced Outage, the message will be rejected.

BID_018 – Bid Volume granularity is equal to 1 MW

The granularity of the Bid Volume provided in a bid is equal to 1 MW. If the Bid Volume has a higher granularity for a bid, the message will be rejected.

Example:

A Bid Volume of 2,5 MW has a higher granularity than 1 MW and therefore a message containing a bid with a Bid Volume of 2,5 MW will be rejected.

BID_019 – Minimum Bid Volume granularity is equal to 1 MW

The granularity of the Minimum Bid Volume provided in a bid is equal to 1 MW. If the Minimum Bid Volume has a higher granularity for a bid, the message will be rejected.

BID_020 – The Bid Volume must be smaller than or equal to the sum of the values of $DP_{mFRR,max}$

For mFRR bids, the Bid Volume must be smaller than or equal to the sum of the $DP_{mFRR,max}$ of the Delivery Points included in the bid. If the Bid Volume of the bid is greater than the sum of the $DP_{mFRR,max}$ of the Delivery Points included in the bid, the message will be rejected.

$$Bid\ Volume \leq \sum_i DP_{mFRR,max}\ of\ DP_i$$

Example:

Bid Volume	30 MW
DP included in the bid	DP A, DP B and DP C
DP _{mFRR,max} DP A	15 MW
DP _{mFRR,max} DP B	12 MW
DP _{mFRR,max} DP C	5 MW

$30 \text{ MW} \leq 32 \text{ MW}$. The Bid Volume is smaller than the sum of the DP_{mFRR,max} of the Delivery Points included in the bid. This means that this bid will be accepted.

Bid Volume	40 MW
DP included in the bid	DP A, DP B and DP C
DP _{mFRR,max} DP A	15 MW
DP _{mFRR,max} DP B	12 MW
DP _{mFRR,max} DP C	5 MW

$40 \text{ MW} > 32 \text{ MW}$. The bid volume is greater than the sum of the DP_{mFRR,max} of the Delivery Points included in the bid. This means that this bid will be rejected.

BID_021 – Per Providing Group of DP_{pg}, the Bid Volume must be smaller than or equal to 100 MW

Per Providing Group, the sum for the DP_{pg} Delivery Points of:

- the Bid Volume of all bids without a conditional link that are not part of an exclusive group
- the maximum Bid Volume per exclusive group
- all bids with a conditional link of type A55 to A60

must be smaller than or equal to 100 MW for all quarter hours.

If the sum of the Bid Volume of all bids without a conditional link, the maximum Bid Volume per exclusive group and all bids with a conditional link of type A55 to A60 is greater than 100 MW for a certain quarter hour, the message will be rejected. The threshold value of 100 MW is defined via a parameter and is subject to change.

BID_022 – The Bid Volume must be smaller than or equal to the sum of the values for technical maximum power

The Bid Volume must be smaller than or equal to the sum of the values for technical maximum power (or Technical P_{max}) for redispatching of the Delivery Points included in the bid. If the Bid Volume is greater than the sum of the values for Technical P_{max} for redispatching of the Delivery Points included in the bid, the message will be rejected.

$$\text{Bid Volume} \leq \sum_i \text{Technical } P_{\max} \text{ of } DP_i$$

Example:

Bid Volume	30 MW
DP included in the bid	DP A, DP B and DP C
Technical P _{max} DP A	15 MW
Technical P _{max} DP B	12 MW
Technical P _{max} DP C	5 MW

30 MW ≤ 32 MW. The Bid Volume is smaller than the sum of the Technical P_{max} of the Delivery Points included in the bid. This means that this bid will be accepted.

Bid Volume	40 MW
DP included in the bid	DP A, DP B and DP C
Technical P _{max} DP A	15 MW
Technical P _{max} DP B	12 MW
Technical P _{max} DP C	5 MW

40 MW > 32 MW. The Bid Volume is greater than the sum of the Technical P_{max} of the Delivery Points included in the bid. This means that this bid will be rejected.

BID_023 – The Bid Volume must be smaller than or equal to the sum of the values of DP_{aFRR,max}

For aFRR bids, the Bid Volume must be smaller than or equal to the sum of the DP_{aFRR,max} of the Delivery Points included in the bid. If the Bid Volume of the bid is greater than the sum of the DP_{aFRR,max} of the Delivery Points included in the bid, the message will be rejected.

$$Bid\ Volume \leq \sum_i DP_{aFRR,max}\ of\ DP_i$$

Example:

Bid Volume	30 MW
DP included in the bid	DP A, DP B and DP C
DP _{aFRR,max} DP A	15 MW
DP _{aFRR,max} DP B	12 MW
DP _{aFRR,max} DP C	5 MW

30 MW ≤ 32 MW. The Bid Volume is smaller than the sum of the DP_{aFRR,max} of the Delivery Points included in the bid. This means that this bid will be accepted.

Bid Volume	40 MW
DP included in the bid	DP A, DP B and DP C
DP _{aFRR,max} DP A	15 MW
DP _{aFRR,max} DP B	12 MW
DP _{aFRR,max} DP C	5 MW

40 MW > 32 MW. The Bid Volume is greater than the sum of the DP_{aFRR,max} of the Delivery Points included in the bid. This means that this bid will be rejected.

BID_024 – Per Providing Group of DP_{pg}, the sum of bid volumes must be smaller than or equal to 50 MW

Per Providing Group of DP_{pg}, the sum of the bid volumes must be smaller than or equal to 50 MW for all quarter hours. If the sum of the Bid Volume is greater than 50 MW for a certain quarter hour, the message will be rejected. The threshold value of 50 MW is defined via a parameter and is subject to change.

BID_025 – No overlap of periods allowed for timeseries of the same Bid Group and for the same direction

On each timeseries a Bid Group Id must be specified. This Bid Group Id is used to link timeseries within a message and links the upward and downward volume of a Providing Group. Timeseries which are linked together via a Bid Group Id and which have the same direction of energy flow cannot have overlapping periods making each bid per direction, per MTU unique. If there are periods with overlapping time intervals for timeseries which are linked and which have the same direction of energy flow, the message is rejected.

Example:

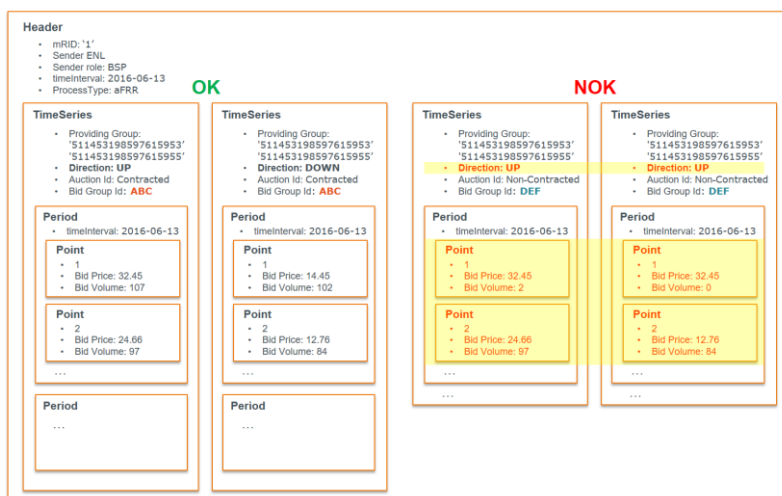

BID_026 – Bid Price granularity is equal to 0,01 €/MWh

The granularity of the Bid Price provided in a bid is equal to 0,01 €/MWh. If the Bid Price has a higher granularity for a bid, the message will be rejected.

BID_027 – The Bid Price must be greater than or equal to a minimum threshold price and must be smaller than or equal to a maximum threshold price

The Bid Price provided in a bid must be:

- greater than or equal to a maximum threshold price determined by Elia
- AND must be smaller than or equal to a minimum threshold price determined by Elia.

If the Bid Price is smaller than the minimum threshold price or greater than the maximum threshold price, the message will be rejected. The values for these thresholds will be determined by Elia.

BID_028 – A warning will be given if the Bid Price is falls out of a threshold range determined by Elia

In every bid in the message, a Bid Price is provided. If this Bid Price falls out of a threshold range determined by Elia, the message will be accepted and a warning will be provided. If the Bid Price falls within the threshold range, the message will be accepted and no warning will be provided.

There will two ranges for the Energy Bids. Elia will set a Bid Price range for Energy Bids in an upward direction and a Bid Price range for Energy Bids in a downward direction. Based on the direction, the Bid Price will be compared with the respective Bid Price range.

BID_029 – Bids with the same parent-child identification must have the same Providing Group

A parent-child identification can be provided in the timeseries. Bids with the same parent-child identification must have the same Providing Group. If there are timeseries where the parent-child identification is identical and where the Providing Group is not identical, the message will be rejected.

Example:

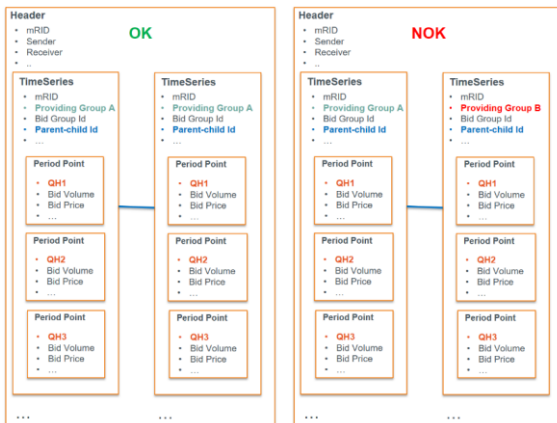

BID_030 – Bids with the same parent-child identification must have the same direction

A direction can be provided in the timeseries. Bids with the same parent-child identification must have the same direction. If there are timeseries where the parent-child identification is identical and where direction is not identical, the message will be rejected.

Example:

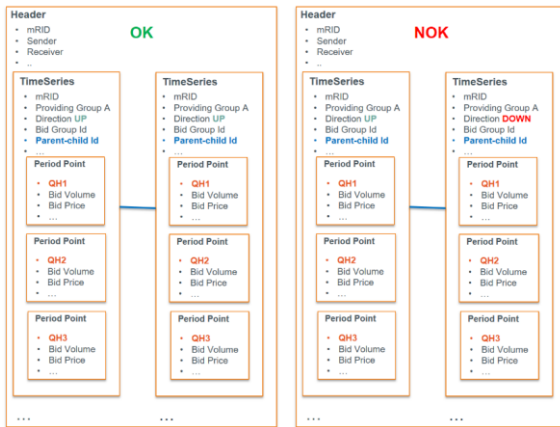

BID_031 – Bids with the same parent-child identification must have the same activation type

For mFRR bids an activation type can be provided for every bid in the timeseries. Bids with the same parent-child identification must have the same activation type for corresponding quarter hours. If there are mFRR bids where the parent-child identification is identical and where the activation type for corresponding quarter hours is not identical, the message will be rejected.

Example:

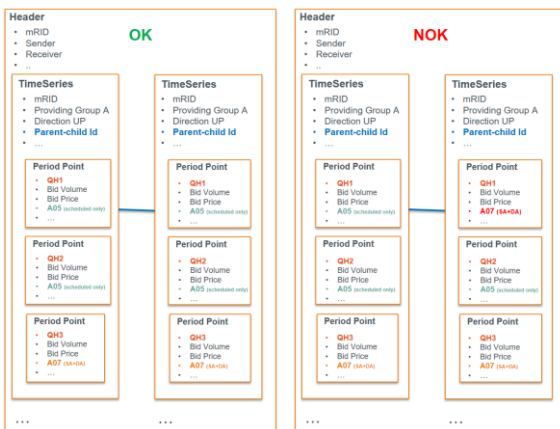

BID_032 – Bids with the same parent-child identification must have different Bid Prices

A parent-child identification can be provided in the timeseries. Bids with the same parent-child identification must have different Bid Prices for corresponding quarter hours. If there are bids where the parent-child identification is identical and where the Bid Price for corresponding quarter hours is the same, the message will be rejected.

Example:

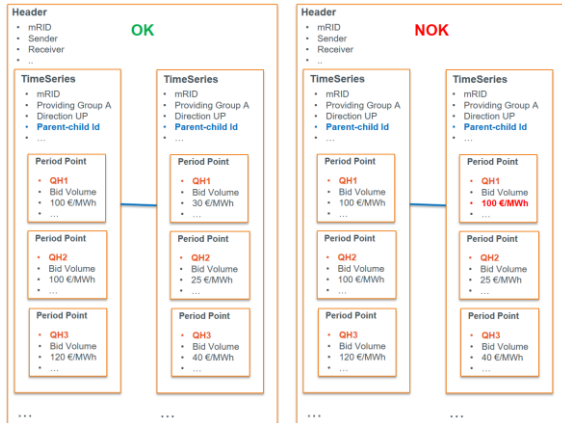

BID_033 – Bids with a parent-child identification cannot have any conditionally linked bid timeseries

A parent-child identification can be provided for bids in the timeseries. Bids with a parent-child identification cannot have any conditionally linked bid timeseries. If a bid contains timeseries with both a parent-child identification and conditionally linked bid timeseries, the message will be rejected.

Example:

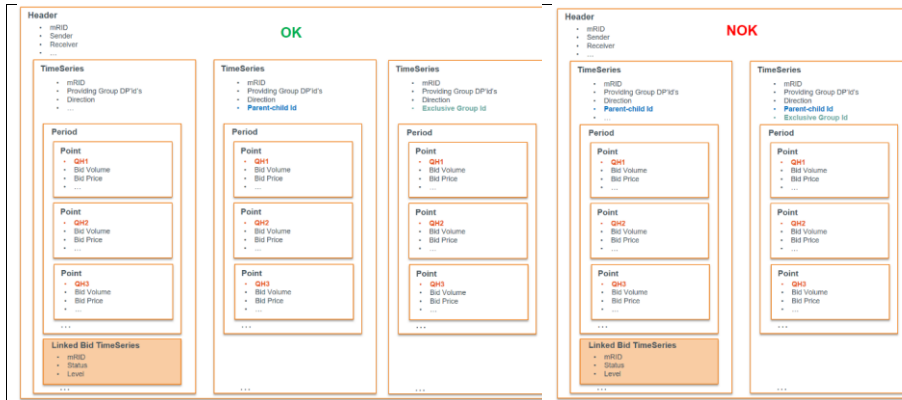

BID_034 – Bids with an exclusive bid identification cannot have any conditionally linked bid timeseries

For mFRR bids, an exclusive bid identification can be provided in the timeseries. If an mFRR bid contains timeseries with both an exclusive bid identification and conditionally linked bid timeseries, the message will be rejected.

Example:



BID_035 – Bids can have maximum one exclusive bid identification

For mFRR bids an exclusive bid identification can be provided in the timeseries. mFRR bids can have maximum one exclusive bid identification per timeseries. If an mFRR bid contains multiple exclusive bid identifications in one timeseries, the message will be rejected.

Example:



Multiple exclusive bid identifications are allowed for redispatching bids.

BID_036 – Bids cannot have both an exclusive bid identification and a parent-child identification

A bid can either have an exclusive bid identification or either a parent-child identification but never both in the same timeseries. If a bid contains a timeseries with both an exclusive bid identification and a parent-child identification, the message will be rejected.

Example:

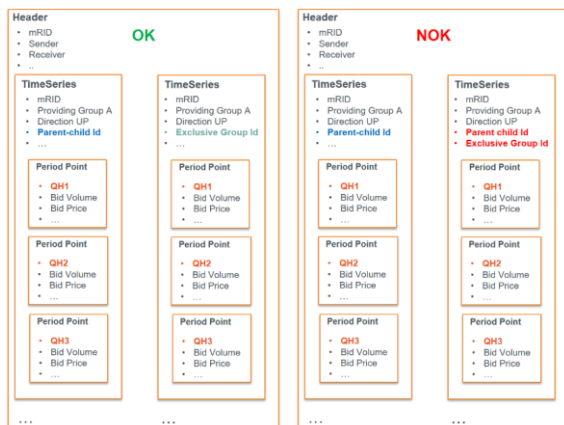

BID_037 – A maximum of six conditionally linked bid timeseries can be provided.

For a timeseries a number of conditionally linked bid timeseries can be provided. The maximum number of conditionally linked bid timeseries that can be provided for a timeseries is six. If a message contains a timeseries with more than six conditionally linked bid timeseries, the message will be rejected.

Additionally, on the linked bid timeseries, a level can be defined. Every timeseries can contain maximum three conditionally linked bid timeseries of level one and maximum three conditionally linked bid timeseries of level two. If a message contains more than three conditionally linked bid timeseries of level one or more than three conditionally linked bid timeseries of level two, the message will be rejected.

Example:

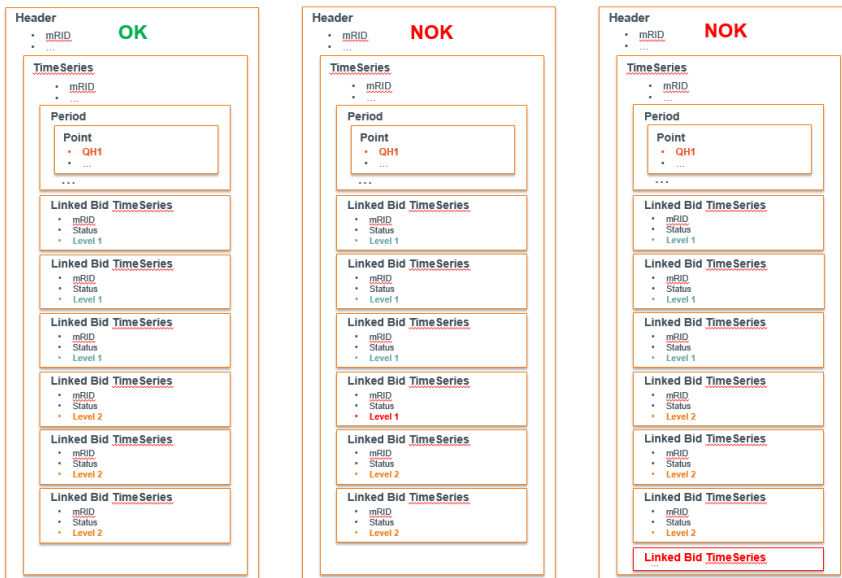

BID_038 – The number of bids in one exclusive group must be smaller than or equal to a specific value for every quarter hour

For mFRR bids, an exclusive bid identification can be provided in the timeseries. The number of bids in one exclusive group must be smaller than or equal to a specific value for every quarter hour. This specific value will be determined at a later stage. If the message contains one or more exclusive groups which have more bids for a quarter hour than a specific value, the message will be rejected.

BID_039 – The number of exclusive groups in every quarter hour must be smaller than or equal to specific value

For mFRR bids, an exclusive bid identification can be provided in the timeseries. The number of exclusive groups used in a quarter hour must be smaller than or equal to a specific value. This specific value will be determined at a later stage. If the message contains a quarter hour for which there are more exclusive groups than a specific value, the message will be rejected.

BID_040 – No technical linking is allowed across Providing Groups

It is not allowed to technically link bids from different Providing Groups. The Bid Group Id is used to technically link bids together. If a message is submitted with a Bid Group Id which is already used for a different Providing Group, the message will be rejected.

Example:

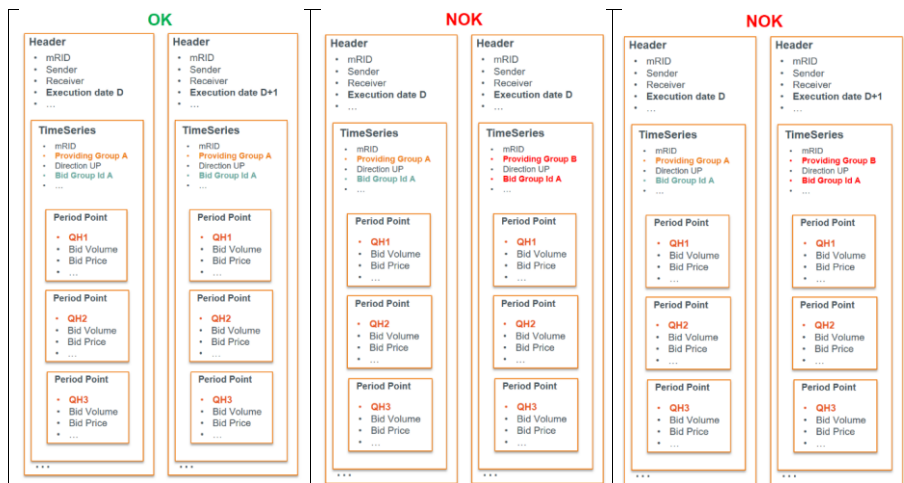

BID_042 – No new Energy Bids can be submitted after Gate Closure Time

It is not allowed to submit new Energy Bids (new Bid Groups or new bids within existing Bid Groups for which bids fall after GCT) after Gate Closure Time. If a message contains new energy bids for a quarter hour of which Gate Closure Time is passed, the message will be rejected.

BID_043 – If bids are updated after BE GCT it is only allowed to reduce the Bid Volume

In exceptional cases (e.g. forced outage,) it is allowed to update bids after Gate Closure Time. When this happens it is only allowed to reduce the Bid Volume for quarter hours for which the Gate Closure Time has passed. All other bid properties for those quarter hours must remain unchanged. If the message contains bids for quarter hours for which the Gate Closure Time has passed and the change is different from a decreasing Bid Volume associated with a reason, the message will be rejected.

It is allowed to reduce the Bid Volume to zero for quarter hours for which the Gate Closure Time has passed. In this case Elia will translate this bid as 'unavailable'.

BID_044 – If bids are updated after the Redispatching Gate Closure Time in case of a forced outage it is only allowed to reduce the Bid Volume

When a Forced Outage occurs, it is allowed to update bids after the Redispatching GCT. When this happens it is only allowed to reduce the Bid Volume for quarter hours for which the Redispatching GCT has already passed and a reason should be set accordingly for those quarter hours. All other bid properties for these quarter hours must remain unchanged. If the message contains new bids or updated bids for quarter hours for which the Redispatching GCT has already passed and the change is different from a decreasing volume associated with the forced outage reason, the message will be rejected.

BID_045 – If bids are updated after BE GCT a reason needs to be provided

For every quarter hour for which the gate closure time has passed and for which the bids are updated, a reason needs to be provided. If the message contains updated bids for quarter hours for which the Gate Closure Time has passed and for which a reason is missing, the message will be rejected.

BID_046 – If bids are updated after the Redispatching Gate Closure Time a reason needs to be provided

For every quarter hour for which the Redispatching GCT has already passed and for which the bids are updated, a reason indicating a forced outage (“Y24 = Forced Outage”) needs to be provided. If the message contains updated bids for quarter hours for which the Redispatching GCT has already passed and for which the reason forced outage (“Y24 = Forced Outage”) is missing, the message will be rejected.

BID_047 – If the Bid Volume is reduced after BE GCT, a warning will be provided to the BSP

In exceptional cases (e.g. forced outage) it is allowed to update bids after Gate Closure Time. It is allowed to reduce the Bid Volume for quarter hours for which the Gate Closure Time has passed. When this happens a warning will be provided to the BSP and the message will be accepted.

BID_048 – The execution date in the message must be greater than or equal to the current date and must be smaller than or equal to current date + 7 days

In the MarketDocument the timeInterval is specified. This timeInterval represents the execution date for the bids included in the MarketDocument. This execution date must be greater than or equal to the current date and must be smaller than or equal to the current date +7 days. If the execution date is smaller than the current date, the message will be rejected. If the execution date is greater than the current date + 7 days, the message will be rejected.

$$\text{Current date} \leq \text{Execution date} \leq \text{Current date} + 7 \text{ days}$$

BID_049 – A Prequalification Bid must contain a bid for every quarter hour of the execution day

A Prequalification Bid must contain only one Bid Group with a bid for every quarter hour of the execution day. If the message does not contain only one Bid Group with a bid for every quarter hour of the execution day, the message will be rejected.

BID_050 – A Prequalification Bid message can only contain Prequalification Bids

In the message it is not allowed the mix Prequalification Bids with offer Energy Bids. An attribute is available on the timeseries to mark bids as a Prequalification Bid. If the message contains timeseries which are marked as Prequalification Bids and timeseries which are marked as offer Energy Bids, the message will be rejected.

BID_051 – A Delivery Point used in a Prequalification Bid cannot be included in an mFRR bid or an aFRR bid or in another Prequalification Bid or be listed as an mFRR Backup Delivery Point or as an aFRR Backup Delivery Point on the same execution date

In a Prequalification Bid message the Delivery Points for the prequalification process are defined. A Delivery Point which is included in a Prequalification Bid cannot be included in an mFRR bid or an aFRR bid or an aFRR Prequalification Bid or an mFRR Prequalification Bid or be listed as an mFRR Backup Delivery Point or as an aFRR Backup Delivery Point on the same execution date. If a Delivery Point from the Prequalification Bid message is used in an mFRR bid or an aFRR bid or in an mFRR or aFRR

Prequalification Bid or in an mFRR or aFRR Backup Delivery Point on the same execution date, the message will be rejected.

BID_052 – The Bid Volume must be greater than zero

The Bid Volume in a bid must be greater than zero. If the Bid Volume is equal to zero or negative for a bid, the message will be rejected.

BID_053 – Bid Volume granularity for Prequalification Bids is equal to 0,1 MW

The granularity of the Bid Volume provided in a Prequalification Bid is equal to 0,1 MW. If the Bid Volume has a higher granularity for a Prequalification bid, the message will be rejected.

Example:

A Bid Volume of 2,54 MW has a higher granularity than 0,1 MW and therefore a message containing a bid with a Bid Volume of 2,54 MW will be rejected.

BID_054 – The Bid Volume for all quarter hours in a Prequalification Bid message must be identical

The Bid Volume for all quarter hours in a Prequalification bid message must be identical. If the Prequalification Bid message contains a quarter hour for which the Bid Volume is different compared to other quarter hours, the message will be rejected.

BID_055 – The Bid Price for Prequalification Bids must be equal to zero

The Bid Price for all quarter hours in a Prequalification bid message must be equal to zero. If the Prequalification Bid message contains a quarter hour for which the Bid Price is not equal to zero, the message will be rejected.

BID_056 – The execution date in the message must be greater than the current date

In the MarketDocument the timeInterval is specified. This timeInterval represents the execution date for the bids included in the MarketDocument. This execution date must be greater than the current date. If the execution date is equal to or smaller than the current date, the message will be rejected.

$$\text{Current date} < \text{Execution date}$$

BID_057 – The Redispatching Energy Bid is received within the standstill period

When a Redispatching Energy Bid is received within the standstill period it will not be confirmed immediately. On the moment the standstill period ends, a second reply with the respective confirmation will be sent. Automatic rejects on the messages received within the standstill period will be sent immediately, in which case no 'Waiting for confirmation' reply will be communicated.

BID_058 – Contracted energy bids updated after BE GCT are only allowed with a reason "Forced Outage"

For every quarter hour for which the Gate Closure Time time has passed and for which contracted energy bids are updated, a reason of 'Forced Outage' needs to be provided. This means that for contracted energy bids updates after BE GCT are only allowed in case of 'Forced Outage'. If the message contains updated contracted bids for quarter hours for which the Gate Closure Time has passed and for which a different reason than 'Forced Outage' is provided, the message will be rejected.

BID_059 – The Delivery Points in a specific quarter hour bid must belong to the Bid Group, if the Bid Group is defined

In the message it is possible to optionally specify the Delivery Points for a specific quarter hour bid. The Delivery Points which are specified in a specific quarter hour bid must belong to the Bid Group if a Bid Group is specified on the timeseries. If the Delivery points of the specific quarter hour bid do not belong to the Bid Group of the timeseries, the message will be rejected.

Example:

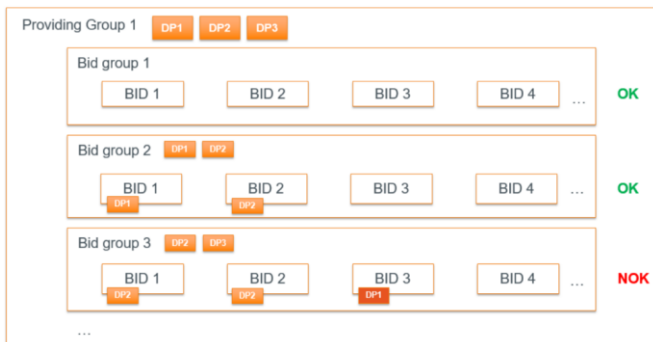

BID_060 – Bids with the same exclusive bid identification must have the same activation type

For mFRR bids an activation type can be provided for every bid in the timeseries. Bids with the same exclusive bid identification must have the same activation type for corresponding quarter hours. If there are mFRR bids where the exclusive bid identification is identical and where the activation type for corresponding quarter hours is not identical, the message will be rejected.

BID_061 – aFRR Energy Bids cannot be updated later than 5 minutes before the validity period of the bid

aFRR bids cannot be updated later than 5 minutes before the validity period of the bid. All bids that are updated after this deadline will be rejected immediately.

BID_062 – Increasing Bid Volume by submitting new or updated non contracted Energy Bids containing Delivery Points located in an electrical zone with a medium or high CRI level may be subject to filtering

Increasing the bid volume on non contracted Energy Bids that contain one or more Delivery Point(s) located in an electrical zone which is experiencing a medium or high CRI level in that period will be accepted but with a warning, as these bids might be filtered out due to congestion reasons at BE GCT. This will only be the case when the increased bid volume is in the same direction as the congestion.

BID_063 – Increasing Bid Volume by submitting new or updated contracted Energy Bids containing Delivery Points located in an electrical zone with a medium or high CRI level is not allowed

Increasing the bid volume on contracted Energy Bids that contain one or more Delivery Point(s) located in an electrical zone which is experiencing a medium or high CRI level in that period will be

rejected. This will only be the case when the increased bid volume is in the same direction as the congestion.

BID_064 – The Bid Volume in the upward and downward direction must be the same

For symmetrical aFRR prequalification Bids (where there is a volume in both directions), the Bid Volume in both directions (the upward and downward direction) must be the same. If an aFRR prequalification bid contains a bid where the Bid Volume for the upward direction is not the same as the Bid Volume for the downward direction, the message will be rejected.

BID_065 – It is not allowed to change the cancellation status for timeseries that have bids in the past

It is not allowed to change the cancellation status of a timeseries that has bids in the past. To resubmit bids of a timeseries that was cancelled and has bids in the past, ongoing or quarter hours that are past BE GCT, a new timeseries should be created.

BID_066 – It is not allowed to list a Delivery Point on Energy Bids for the same quarter hour in different Providing Groups

On a given Execution Date, a same Delivery Point cannot be listed in different bids on the same quarter hour in two different Providing Groups. Although Delivery Points can be used in multiple Providing Groups, they can only relate to different bids for the same quarter hour for an Execution Date within a specific Providing Group.

BID_067 – The Neutralization Time (NT) must be a multiple of 15 minutes

For mFRR Energy Bids, the Neutralization Time (NT) can be provided in the timeseries. This NT must be a multiple of 15 minutes and must be greater than zero. If the NT for mFRR Energy Bids is not a multiple of 15 minutes (except 0), the message will be rejected.

Bid_068 – Bids cannot be conditionally available and conditionally unavailable at the same time.

For a timeseries a number of conditionally linked bid timeseries can be provided. For every linked bid timeseries the status is indicated. There are two groups of statuses:

- Statuses which indicate a **conditional availability: A67 to A72**
 - **A67** = Available if linked bid activated
 - **A68** = Available if linked bid rejected
 - **A69** = Available if linked bid subject to SA
 - **A70** = Available if linked bid subject to DA
 - **A71** = Available for DA if linked bid subject to DA
 - **A72** = Available for DA if linked bid subject to SA
- Statuses which indicate a **conditional unavailability: A55 to A60**
 - **A55** = Not available if linked bid activated
 - **A56** = Not available if linked bid rejected
 - **A57** = Not available for DA if linked bid subject to DA
 - **A58** = Not available for DA if linked bid subject to SA
 - **A59** = Not available if linked bid subject to SA
 - **A60** = Not available if linked bid subject to DA

A bid cannot be conditionally available and conditionally unavailable at the same time. This means it is not allowed to combine statuses from both groups for the same linked bid timeseries. If a message contains a linked bid timeseries which indicates both a conditionally availability and a conditionally unavailability at the same time, the message will be rejected.

BID_069 – The Minimum Activation Time (MIT) must be a multiple of 15 minutes

For redispatching Bids the Minimum Activation Time (MIT) can be provided in the timeseries. This MIT must be a multiple of 15 minutes and must be greater than zero. If the MIT for redispatching Bids is not a multiple of 15 minutes, the message will be rejected.

BID_070 – Bids cannot have both a Minimum Activation Time (MIT) and a parent-child identification

A bid can either have a Minimum Activation Time greater than zero or either a parent-child identification but never both at the same time, in the same timeseries. If a message contains a timeseries with both a Minimum Activation Time greater than zero and a parent-child identification, the message will be rejected.

BID_071 – Bids cannot have a Minimum Activation Time (MIT) that is greater than the Maximum Activation Time (MAT)

It is possible for bids to have both a Minimum Activation Time (MIT) and a Maximum Activation Time (MAT). If both the Minimum Activation Time and the Maximum Activation Time are defined, then the Minimum Activation Time must be smaller than or equal to the Maximum Activation Time. If a message contains a timeseries with both a Minimum Activation Time and Maximum Activation Time which are greater than zero and the Minimum Activation Time is greater than the Maximum Activation Time, then the message will be rejected.

Deleted: both

Deleted: and

Deleted: a

BID_072 – Bids with a Minimum Activation Time (MIT) can be used only if a condition A67 as conditional link is included

A bid can only have a Minimum Activation Time greater than zero if the bid also has a conditional link with the condition A67. This means the bid needs to have a linked bid timeseries using the status A67 either in level 1 or level 2. If a message contains a timeseries with a Minimum Activation Time greater than zero without a conditional link with the condition A67, the message will be rejected.

Deleted: A bid can either have a Minimum Activation Time greater than zero or either a Maximum Activation Time (MAT) greater than zero but never both at the same time, in the same timeseries. If a message contains a timeseries with both a Minimum Activation Time greater than zero and a Maximum Activation Time greater than zero, the message will be rejected.

BID_073 – Bids cannot have both a Minimum Activation Time (MIT) and a Full Activation Time (FAT) higher than default value

A bid can either have a Minimum Activation Time greater than zero or either a Full Activation Time greater than the default value of 12,5 minutes but never both at the same time, in the same timeseries. If a message contains a timeseries with both a Minimum Activation Time greater than zero and a Full Activation Time greater than the default value of 12,5 minutes, the message will be rejected.

BID_074 – Updates for Bids for which an activation request has been sent are not allowed

It is not allowed to update an mFRR Energy Bid for which an activation request has been sent. If the message contains an update of an mFRR Energy bid for which an activation request has been sent, then the message will be rejected.

BID_075 – mFRR Energy Bids cannot be updated later than 5 minutes after the start of the validity period of the bid

mFRR bids cannot be updated later than 5 minutes after the start of the validity period of the bid. All bids that are updated after this deadline will be rejected immediately

BID_076 – RD Energy Bids cannot be updated later than the start of the validity period of the bid

RD bids cannot be updated later than the start of the validity period of the bid. All bids that are updated after this deadline will be rejected immediately.

BID_077 – Conditionally linked bid timeseries must exist

The conditionally linked bid timeseries, which is used for conditional linking must exist. If the conditionally linked bid timeseries does not exist (yet), the message will be accepted and a warning will be provided to the BSP/SA.

The MARI platform does not accept bids that are linked to a bid that do not exist. This means that for a bid timeseries linked to another bid timeseries in quarter-hours where it does not exist, Elia will remove the conditional links to quarter hours that do not exist before sending the information to MARI. To avoid such modification from Elia, the method described in the following remark must be followed.

This also means that bids with a link A55, A57, A58, A59, A60 and A68 will be considered as Available (for DA and/or SA according to the initial condition) if they are linked to a timeseries that do not exist in the previous quarter-hours and bids with a link A56, A67, A69, A70, A71, A72 will be considered as Not Available (for DA and/or SA according to the initial condition) if they are linked to a timeseries that do not exist in the previous quarter-hours.

Remark: This implies that a certain order must be respected when submitting the Energy Bids in order to avoid the warning. First the Energy bids to where the conditional link will be made, must be created. After that the Energy Bid from where the link is made can be created. Please also note that messages are not necessarily processed in exactly the same order as in which they are sent. As confirmation of the creation of the Energy Bid is advised to await for the bid answer message.

Remark: In case the bids do not cover a continuous period then special attention is needed for the first bid (in case of level 1 conditional linking) and the second bid (in case of level 2 conditional linking) of the starting period. Please see the example below.

- **Bid0** of BidGroup1 is conditionally linked to a bid that does not exist. There are no bids in BidGroup1 before Bid0 in Qh0.
- **Bid10** of BidGroup2 is conditionally linked to a bid that does not exist. There are no bids in BidGroup 1 before Bid0 in Qh0.
- **Bid11** of BidGroup2 is conditionally linked to a bid that does not exist. There are no bids in BidGroup 1 before Bid0 in Qh0.
- **Bid1** of BidGroup1 is conditionally linked to Bid0
- **Bid12** of BidGroup2 is conditionally linked to Bid0
- ...

		Qh0	Qh1	Qh2	Qh3	Qh4
BidGroup1	Timeserie	TimeseriesA				
	Bid	Bid0	Bid1	Bid2	Bid3	Bid4
	Conditional link	To: BidGroup1 Level 1 Status: Axx	To: BidGroup1 Level 1 Status: Axx	To: BidGroup1 Level 1 Status: Axx	To: BidGroup1 Level 1 Status: Axx	To: BidGroup1 Level 1 Status: Axx
BidGroup2	Timeserie	TimeseriesB				
	Bid	Bid10	Bid11	Bid12	Bid13	Bid14
	Conditional link	To: BidGroup1 Level 2 Status: Axx	To: BidGroup1 Level 2 Status: Axx	To: BidGroup1 Level 2 Status: Axx	To: BidGroup1 Level 2 Status: Axx	To: BidGroup1 Level 2 Status: Axx

This can be solved by creating multiple timeseries. Separate timeseries can be created for the first and second bid of a starting period when needed. These timeseries in that case should not contain any conditional links to bids which do not exist. Please see the example below.

		Qh0	Qh1	Qh2	Qh3	Qh4
BidGroup1	Timeserie	TimeseriesA	TimeseriesB			
	Bid	Bid0	Bid1	Bid2	Bid3	Bid4
	Conditional link		To: BidGroup1 Level 1 Status: Axx	To: BidGroup1 Level 1 Status: Axx	To: BidGroup1 Level 1 Status: Axx	To: BidGroup1 Level 1 Status: Axx
BidGroup2	Timeserie	TimeseriesC		TimeseriesD		
	Bid	Bid10	Bid11	Bid12	Bid13	Bid14
	Conditional link			To: BidGroup1 Level 2 Status: Axx	To: BidGroup1 Level 2 Status: Axx	To: BidGroup1 Level 2 Status: Axx

- Bid0 of BidGroup1 is now included in TimeseriesA which does not have any conditional links.
- Bid10 of BidGroup1 is now included in TimeseriesC which does not have any conditional links.
- Bid11 of BidGroup1 is now included in TimeseriesC which does not have any conditional links.
- Bid1 of BidGroup1 is conditionally linked to Bid0
- Bid12 of BidGroup2 is conditionally linked to Bid0
- ...

If the bidding period is continuous, then the bids in the previous quarter hours will exist and no warning will be provided.

BID_078 – Bids cannot be conditionally linked more than once to a given bid

It is not allowed to conditionally link an Energy Bid more than once to a given Energy Bid in level 1 or in level 2. If a bid is conditionally linked twice or more to the same bid on the same level, the message will be rejected.

Example:

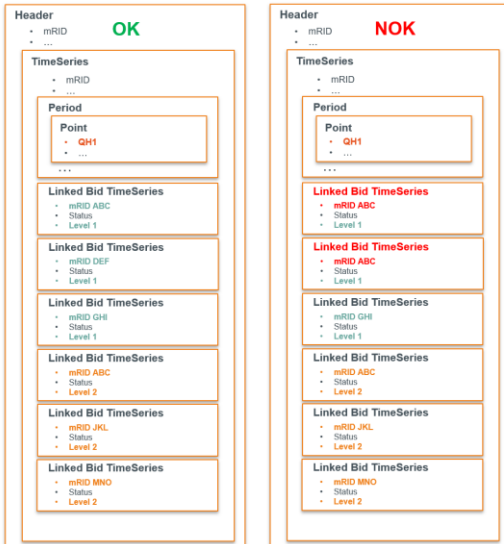

BID_079 – Bids cannot be cancelled if the Energy Bid is used in a conditional link

If an Energy Bid is used in a conditional link, then the Energy Bid cannot be cancelled. If such an Energy Bid needs to be cancelled, then first the conditional link in the other Energy Bid must be removed and then the concerned Energy Bid can be cancelled. If the message contains a cancellation of an Energy Bid which is used in a conditional link, then the message will be rejected.

Example:

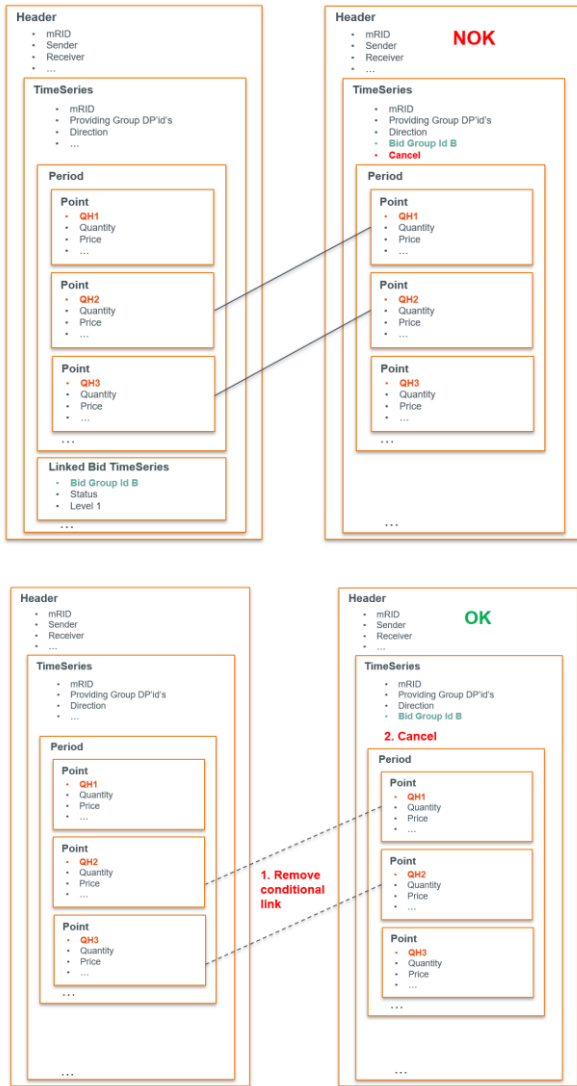

BID_080 – The Maximum Energy Level for bids of the same providing group must be the same per direction and per quarter hour

For bids belonging to the same Providing Group, the Maximum Energy Level must be the same per direction and per quarter hour. If the message contains bids from the same Providing Group for which the Maximum Energy Level is different for the same direction and the same quarter hour, the message will be rejected. The Maximum Energy Level is provided per Providing Group, per direction and per

quarter hour. For the same Providing Group it is allowed to change the Maximum Energy Level if the direction is different and/or if the quarter hour is different.

Example:

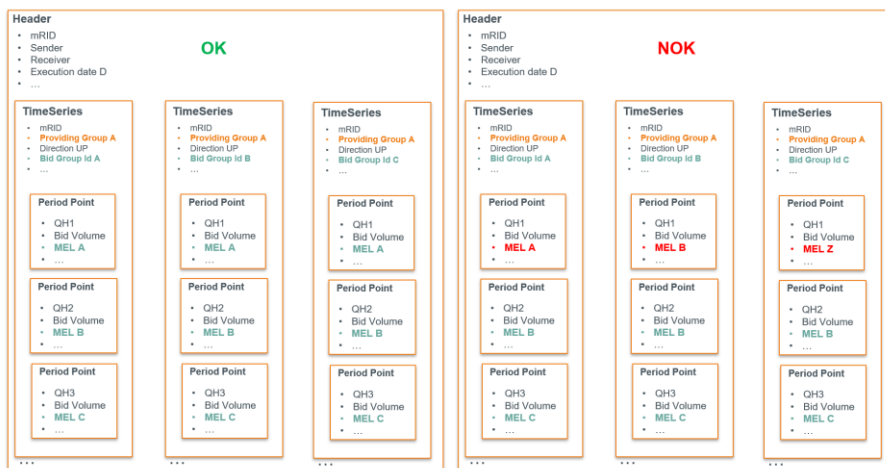

BID_081 – If a Maximum Energy Level is defined for a bid, then it must be defined for all bids from the Providing Group

If a Providing Group contains a bid where a Maximum Energy Level is defined, then a Maximum Energy Level must be defined for all bids from that Providing Group. If the message contains bids where the Maximum Energy Level is defined and also bids where the Maximum Energy Level is missing, then the message will be rejected.

BID_082 – The Maximum Energy Level must be greater than or equal to zero

The Maximum Energy Level in the bid must be greater than or equal to zero. If the Maximum Energy Level is negative, the message will be rejected.

BID_083 – Bids cannot have both a Maximum Energy Level and a Maximum Activation Time

An Energy Bid can either have a Maximum Energy Level or either a Maximum Activation Time, but never both. If the message contains an energy bid with a Maximum Energy Level and a Maximum Activation Time, the message will be rejected.

BID_084 – Bids with the same parent-child or exclusive group identification must have the same availability

The MARI platform requires that bids which have the same parent-child identification or same exclusive group identification have the same availability. When the volume of an mFRR Energy Bid in BIPLE is updated to zero, Elia translates the bid to 'unavailable' when submitting the bid to MARI. When submitting bids to MARI, Elia needs to ensure that either all bids in an exclusive or parent-child group are available or all bids in the group are unavailable.

In case the message contains a bid update which creates an exclusive group or parent-child group which contains bids with both an available and unavailable status, a warning will be provided to the BSP and the message will be accepted.

Please note that as soon as one of the bids from a parent-child group or an exclusive group is 'unavailable' then all bids from that group will be submitted as 'unavailable' to the MARI platform. Before GCT, this situation can be avoided by removing the unavailable bid(s) from the respective parent-child or exclusive group. After GCT, it is not allowed to change the composition of the parent-child groups or exclusive groups anymore. Which in that case means that all bids from that group will be submitted as 'unavailable' to the MARI platform. In order to avoid any local activations on the remaining available bids from the parent-child or exclusive group, the volume of all bids can be updated to zero by the Market party.

BID_085 – All bids from the same Bid Group must have the same direction

On each timeseries a Bid Group Id must be specified. A Bid Group Id can only be used for one direction. If a message contains a Bid Group which contains bids from different directions, the message will be rejected.

BID_086 – It is not allowed to update the Bid Group Id of existing timeseries

For all timeseries provided within a message, a Bid Group Id must be provided. Once a Bid Group Id has been provided for a certain timeseries then this Bid Group Id must remain unchanged. It is not allowed to change the bid Group Id of an existing timeseries. If a message, contains an update of the Bid Group Id for an existing timeseries, the message will be rejected.

In case a mistake was made when submitting a timeseries with a certain Bid Group Id, then the existing timeseries can be cancelled and one or multiple new timeseries can be created with the adjusted Bid Group Id(s).

Deleted: ¶

12.5 Backup Delivery Points

BACK_001 – The time period of the message must exactly cover one day

In the message a time interval is specified. This time interval must exactly cover one full day. In the message the date and time fields are expressed in UTC time.

In local time this means that:

- The start date and time for the message on day D is expected to be 'date day D' 00:00:00
- The end date and time for the message on day D is expected to be 'date day D+1' 00:00:00

In UTC time this means that:

In the period where summer time applies (from the last Sunday in March to the last Sunday of October):

- The start date and time for the message on day D is expected to be 'date day D-1' 22:00:00
- The end date and time for the message on day D is expected to be 'date day D' 22:00:00

In the period where winter time applies (from the last Sunday of October to the last Sunday in March):

- The start date and time for the message on day D is expected to be 'date day D-1' 23:00:00
- The end date and time for the message on day D is expected to be 'date day D' 23:00:00

If the message time interval covers less or more than one full day, the message will be rejected.

BACK_002 – The combination of MarketDocument mRID and the sender marketParty mRID must be unique per MarketDocument time interval

The combination of the MarketDocument mRID and sender marketParty mRID must be unique per MarketDocument time interval. This means that every sender marketParty must use the same MarketDocument mRID on a given MarketDocument time interval (= execution date). If a message is received from a sender marketParty on an execution date for which another MarketDocument mRID already exists, the message will be rejected.

BACK_003 – The BSP must have a valid BSP contract and all Delivery Points must be included in the pool of the BSP

In the header of the MarketDocument the BSP is indicated as sender market participant. The BSP must have a valid BSP contract for the respective type which is valid on the execution date of the MarketDocument and all Delivery Points used in the MarketDocument must be included in the pool of the BSP.

BACK_004 – The DP_{PG} backup Delivery Points cannot be listed in an aFRR bid or as an aFRR backup Delivery Point on the same quarter hour on the same execution date

The backup Delivery Points in the list cannot be listed in an aFRR bid or as an aFRR backup Delivery Point on the same quarter hour on the same execution date. If the list of back up Delivery Points contains a Delivery Point which is listed in an aFRR bid or as an aFRR backup Delivery Point on the same quarter hour on the same execution date, the message will be rejected.

BACK_005 – The DP_{PG} backup Delivery Points cannot be listed in an mFRR bid or as an mFRR backup Delivery Point on the same quarter hour on the same execution date

The backup Delivery Points in the list cannot be listed in an mFRR bid or as an mFRR backup Delivery Point on the same quarter hour on the same execution date. If the list of back up Delivery Points contains a Delivery Point which is listed in an mFRR bid or as an mFRR backup Delivery Point on the same quarter hour on the same execution date, the message will be rejected.

BACK_006 – The backup Delivery Points cannot be listed in a Prequalification Bid on the same execution date

The backup Delivery Points cannot be listed as a Prequalification Bid on the same execution date. If a backup Delivery Point is listed as a Prequalification Bid on the execution date, the message will be rejected.

BACK_007 – Updates to backup Delivery Points after Gate Closure Time are not allowed

It is not allowed to make updates to the submitted backup Delivery Points after Gate Closure Time. It is not allowed to add new or remove submitted backup Delivery Points after Gate Closure Time. If a message contains updates to backup Delivery Points for a quarter hour of which the Gate Closure Time is passed, the message will be rejected.

12.6 Activations

ACT_001 - Confirmation deadline not respected

The activation confirmation message is expected:

- for the 1st activation confirmation message: at the latest 5 minutes after the activation request
- for the 2nd activation confirmation message: 3 minutes after the end of the activation (8 mins after the end of the last quarter of activation)

Formatted: English (United States)

ACT_002 – TimeSeries not matching

This warning is triggered if the time series are not matching. For instance, if there are less or more time series than expected.

ACT_003 – Resolution inconsistency

This warning is triggered if the resolution is not “PT15M”

ACT_004 – Quantity inconsistency

This warning is triggered if the format of the quantity field is not respected

ACT_005 – Quantity increased

This warning is triggered if the point quantity in the activation confirmation message is higher than the point quantity in the activation requested message

The point quantity should be equal to the sum of registeredResource quantities in the activation confirmation messages

ACT_006 – Quantity decreased

This warning is triggered if the point quantity in the activation confirmation message is higher than the point quantity in the activation requested message

The point quantity should be equal to the sum of registeredResource quantities in the activation confirmation messages

ACT_007 – Resource Object Invalid

This warning is triggered if unexpected delivery points are received in the activation confirmation message.

The delivery points expected in the activation confirmation message are the delivery points included in the activated bids for the 1st activation confirmation message and the same or a subset of those delivery points for the 2nd activation confirmation message except for mFRR bids activated in the context of Balancing for which the expected delivery points are:

- for the 1st activation confirmation message: only delivery points included in the activated bids, other bids submitted for the concerned quarter-hour (and in the backup list for mFRR activations)
- for the 2nd activation confirmation message: only delivery points included in the 1st activation confirmation message. If the 1st activation confirmation message has not been received, the

rules for the 1st activation confirmation message applies to the 2nd activation confirmation message.

12.7 Requests

REQ_001 - The request did not generate any results

When no results are found based on the request, this request validation rule will be applied and inform the user that no results will be returned.

REQ_002 - The number of requests per 15 minutes cannot exceed the threshold limit

The number of requests per 15 minutes that Elia will process are limited. If the number of requests for an information flow per 15 minutes has reached the threshold limit determined by Elia, then no additional requests for this information flow will be processed. This means that if an additional request for the information flow⁷ is launched, the message will be rejected and that no results will be returned.

REQ_003 – The request can cover maximum one execution day

The request can only cover a period within one execution day.

⁷ For the Bidding information flows, a limit per Energy Bidding product per 15 minutes is determined by Elia
Page 239 of 262

13 MarketDocuments

This chapter contains the technical definition of the MarketDocuments used for all messages exchanged through the Elia External Communication Layer.

13.1 Schedule_MarketDocument

13.1.1 Format

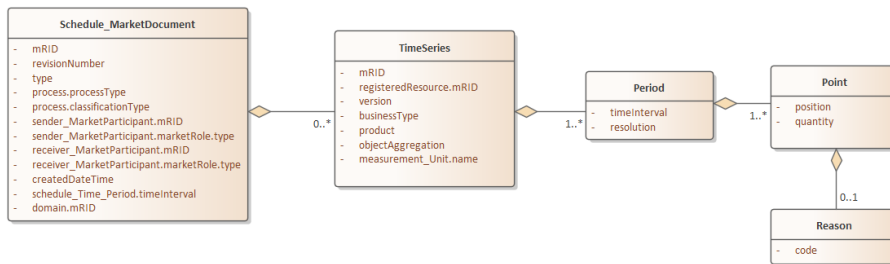

13.1.2 Attributes

Schedule_MarketDocument			
Field	Mandatory	Data Type	Description
mRID	Y	string	Unique identification of the MarketDocument
revisionNumber	Y	int	Version number for the market document
type	Y	string	The coded type of the market document
process.processType	Y	string	The identification of the nature of process that the document addresses
process.classificationType	Y	string	The classification mechanism used to group a set of objects together within a business process
sender_MarketParticipant.mRID	Y	string	The identification of the sender
sender_MarketParticipant.marketRole.type	Y	string	The role code associated with the sender
receiver_MarketParticipant.mRID	Y	string	The identification of the receiver
receiver_MarketParticipant.marketRole.type	Y	string	The role code associated with the receiver
createdDateTime	Y	Datetime	The date and time of the creation of the document
schedule_Time_Period.timeInterval	Y	timeInterval	The start and end date and time for a given interval
domain.mRID	Y	string	The unique identifier of the domain
TimeSeries	N	List of TimeSeries	The list of timeseries associated to the market document

TimeSeries			
Field	Mandatory	Data Type	Description
mRID	Y	string	Identification of the timeseries
version	Y	string	The identification of the version of the timeseries

businessType	Y	string	The identification of the nature of the timeseries
product	Y	string	The energy product of the schedule timeseries
objectAggregation	Y	string	The identification of the object that is used to aggregate a timeseries
registeredResource.mRID	Y	string	The delivery point EAN representing the point for which the schedule is sent
measurement_Unit.name	Y	string	The identification of the formal code for a measurement unit
Period	Y	List of Period	The list of periods associated to the timeseries

Period			
Field	Mandatory	Data Type	Description
timeInterval	Y	timeInterval	The start and end date and time for a given interval
resolution	Y	string	The definition of the number of units of time that compose an individual step within a period
Point	Y	List of Point	List of points associated the the period

Point			
Field	Mandatory	Data Type	Description
position	Y	int	A sequential value representing the relative position within a given time interval
quantity	Y	decimal	The principal quantity identified for a point
Reason	N	List of Reason	List of reasons associated to the point

Reason			
Field	Mandatory	Data Type	Description
code	Y	string	Code of the reason

timeInterval			
Field	Mandatory	Data Type	Description
start	Y	Datetime	The start date and time of the interval
end	Y	Datetime	The end date and time of the interval

13.2 ReserveBid_MarketDocument

13.2.1 Format

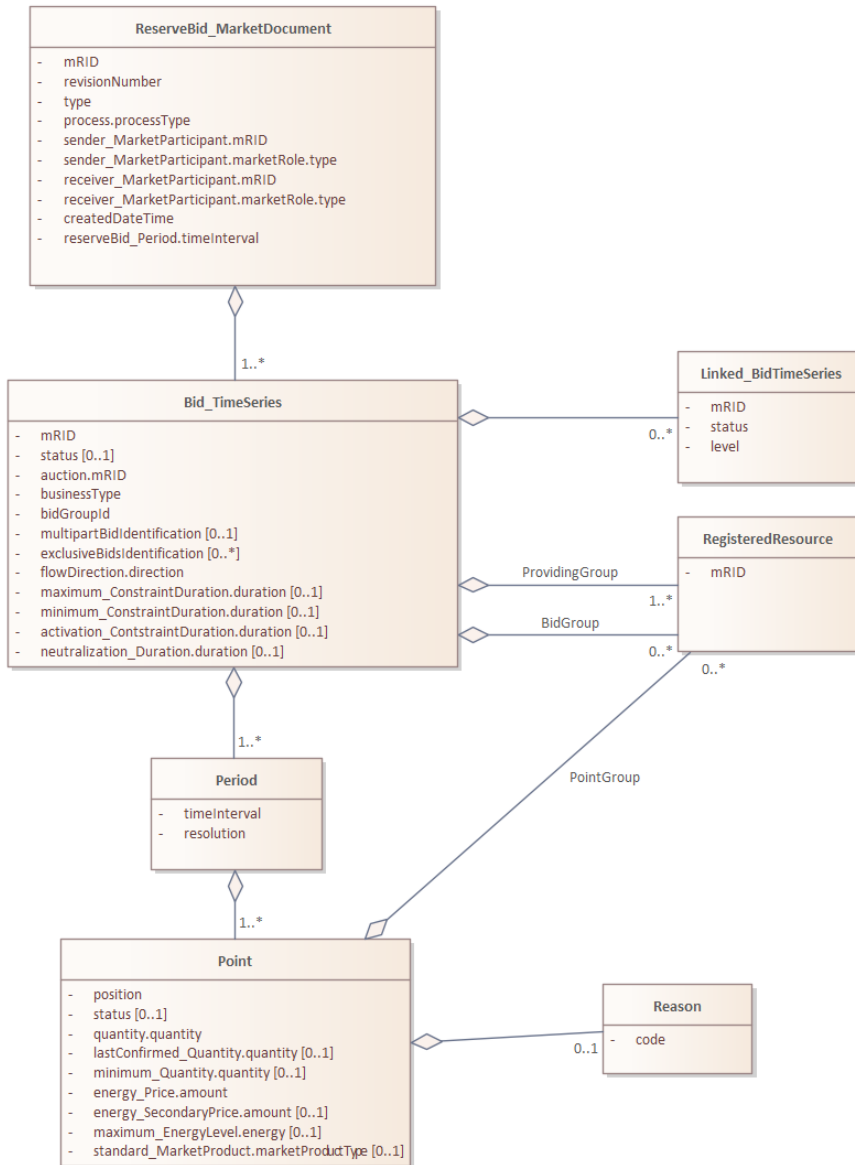

13.2.2 Attributes

ReserveBid_MarketDocument			
Field	Mandatory	Data Type	Description
mRID	Y	string	Unique identification of the MarketDocument
revisionNumber	Y	int	Version number for the MarketDocument
type	Y	string	The coded type of the MarketDocument
process.processType	Y	string	The identification of the nature of process that the document addresses
sender_MarketParticipant.mRID	Y	string	The identification of the sender
sender_MarketParticipant.marketRole.type	Y	string	The role code associated with the sender
receiver_MarketParticipant.mRID	Y	string	The identification of the receiver
receiver_MarketParticipant.marketRole.type	Y	string	The role code associated with the receiver
createdDateTime	Y	Datetime	The date and time of the creation of the document
reserveBid_Period.timeInterval	Y	timeInterval	The start and end date and time for a given interval
Bid_TimeSeries	Y	List of Bid_TimeSeries	The list of timeseries associated to the MarketDocument

Bid_TimeSeries			
Field	Mandatory	Data Type	Description
mRID	Y	string	Identification of the timeseries
status	N	string	The information about the status of the bid
auction.mRID	N	string	Indicates if the bid is contracted or not contracted
businessType	Y	string	The identification of the nature of the timeseries
bidGroupld	Y	string	The unique identification used to identify associated bids with each other
multipartBidIdentification	N	string	The identification used to associate multipart bids
exclusiveBidsIdentification	N	List of string	The identification used to associate exclusive bids
ProvidingGroup	Y	List of RegisteredResource	A list of registered resources that define the Providing Group
BidGroup	N	List of RegisteredResource	A list of registered resources for the Bid Group
flowDirection.direction	Y	string	The coded identification of the direction of an energy flow
activation_ConstraintDuration.duration	N	decimal	Delay to reach the requested maximum Bid Volume
maximum_ConstraintDuration.duration	N	decimal	Maximum duration for which the maximum bid volume can be activated

minimum_ConstraintDuration.duration	N	decimal	Minimum Activation time (in min) during which the bid needs to be activated
neutralization_Duration.duration	N	decimal	Time during which the bid volume cannot be activated after a previous activation that has ended
Linked_BidTimeSeries	N	List of Linked_BidTimeSeries	List of conditionally linked Bid Groups for the timeseries
Period	Y	List of Period	List of periods associated to the timeseries

Period			
Field	Mandatory	Data Type	Description
timeInterval	Y	timeInterval	The start and end date and time for a given interval
resolution	Y	string	The definition of the number of units of time that compose an individual step within a period
Point	Y	List of Point	List of points associated to the period

Point			
Field	Mandatory	Data Type	Description
position	Y	int	A sequential value representing the relative position within a given time interval
status	N	string	The confirmation status of the bid
quantity.quantity	Y	decimal	The quantity (or Bid Volume) that can be activated
lastConfirmed_Quantity.quantity	N	decimal	The confirmed quantity
minimum_Quantity.quantity	N	decimal	The minimum quantity (or Minimum Bid Volume (indivisible volume)that must be activated
energy_Price.amount	Y	decimal	The Bid Price expressed for each unit of quantity
energy_SecondaryPrice.amount	N	decimal	The Bid Price expressed for each unit of quantity. Only used for Merged Bids
maximum_EnergyLevel.energy	N	decimal	The Maximum Energy Level (MEL) indicates the maximum remaining energy for the Providing Group.
standard_MarketProduct.marketProductType	N	string	The type of product on a market view
PointGroup	N	List of RegisteredResource	A list of registered resources to which the interval of this bid is related
Reason	N	List of Reason	List of reasons associated to the point

Linked_BidTimeSeries

Field	Mandatory	Data Type	Description
mRID	Y	string	The identification to the linked element
status	Y	string	The condition for the conditional link
level	Y	string	The position of the linked bid with respect to the current bid

RegisteredResource			
Field	Mandatory	Data Type	Description
mRID	Y	string	EAN code of a delivery point

Reason			
Field	Mandatory	Data Type	Description
code	Y	string	Code of the reason

timeInterval			
Field	Mandatory	Data Type	Description
start	Y	Datetime	The start date and time of the interval
end	Y	Datetime	The end date and time of the interval

13.3 Activation_MarketDocument

13.3.1 Format

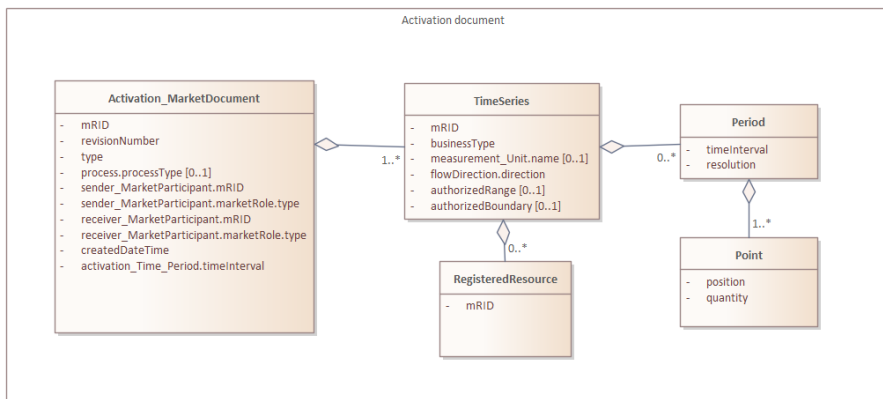

13.3.2 Attributes

Activation_MarketDocument

Field	Mandatory	Data Type	Description
mRID	Y	string	Unique identification of the MarketDocument
revisionNumber	Y	int	Version number for the MarketDocument
type	Y	string	The coded type of the MarketDocument
process.processType	N	string	The identification of the nature of process that the document addresses
sender_MarketParticipant.mRID	Y	string	The identification of the sender
sender_MarketParticipant.marketRole.type	Y	string	The role code associated with the sender
receiver_MarketParticipant.mRID	Y	string	The identification of the receiver
receiver_MarketParticipant.marketRole.type	Y	string	The role code associated with the receiver
createdDateTime	Y	Datetime	The date and time of the creation of the document
activation_Time_Period.timeInterval	Y	timeInterval	The start and end date and time for a given interval
TimeSeries	Y	List of TimeSeries	The list of timeseries associated to the MarketDocument

TimeSeries			
Field	Mandatory	Data Type	Description
mRID	Y	string	Identification of the timeseries
businessType	Y	string	The identification of the nature of the timeseries
measurement_Unit.name	N	string	The identification of the formal code for a measurement unit
RegisteredResource	N	List of RegisteredResource	The delivery point EAN(s)
flowDirection.direction	Y	string	The coded identification of the direction of an energy flow
authorizedRange	N	string	Range for a return to schedule
authorizedBoundary	N	Decimal	Boundary of the range for a return to schedule
Period	N	List of Period	This list of periods associated to the timeseries

Period			
Field	Mandatory	Data Type	Description
timeInterval	Y	timeInterval	The start and end date and time for a given interval
resolution	Y	string	The definition of the number of units of time that compose an individual step within a period
Point	Y	List of Point	List of points associated the period

Point			
Field	Mandatory	Data Type	Description
position	Y	int	A sequential value representing the relative position within a given time interval

quantity	Y	decimal	The principal quantity identified for a point
----------	---	---------	---

timeInterval			
Field	Mandatory	Data Type	Description
start	Y	Datetime	The start date and time of the interval
end	Y	Datetime	The end date and time of the interval

RegisteredResource			
Field	Mandatory	Data Type	Description
mRID	Y	string	EAN code of a delivery point

13.4 Unavailability_MarketDocument

13.4.1 Format

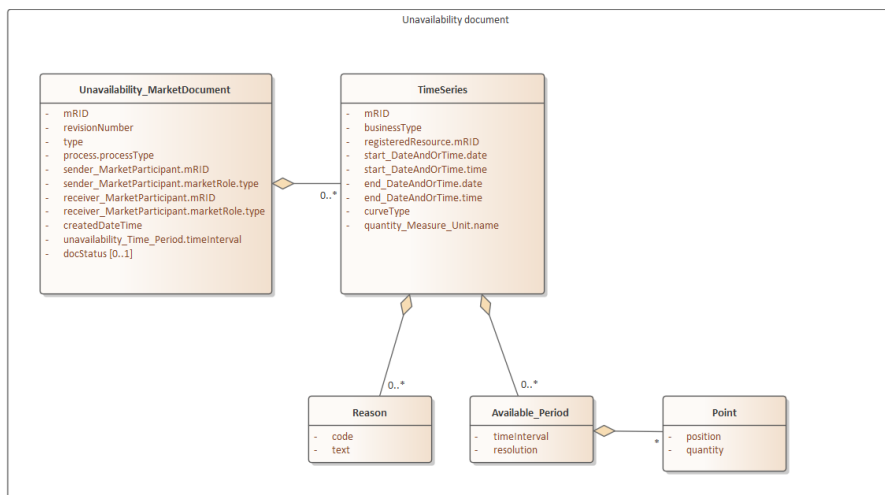

13.4.2 Attributes

Unavailability_MarketDocument			
Field	Mandatory	Data Type	Description
mRID	Y	string	Unique identifier for the MarketDocument
revisionNumber	Y	int	Version number for the MarketDocument.
type	Y	string	The coded type of the MarketDocument

process.processType	Y	string	The identification of the nature of process that the document addresses
sender_MarketParticipant.mRID	Y	string	The identification of the sender
sender_MarketParticipant.marketRole.type	Y	string	The role code associated with the sender
receiver_MarketParticipant.mRID	Y	string	The identification of the receiver
receiver_MarketParticipant.marketRole.type	Y	string	The role code associated with the receiver
createdDateTime	Y	string	The date and time of the creation of the document
unavailability_Time_Period.timeInterval	Y	timeInterval	The start and end date and time for a given interval
docStatus	N	string	Status of the MarketDocument
TimeSeries	N	List of TimeSeries	List of timeseries associated to the MarketDocument

TimeSeries			
Field	Mandatory	Data Type	Description
mRID	Y	string	Identification of the timeseries
businessType	Y	string	The identification of the nature of the timeseries
registeredResource.mRID	Y	string	The delivery point EAN representing the point for which the unavailability is sent
start_DateAndOrTime.date	Y	date	The start date
start_DateAndOrTime.time	Y	time	The start time
end_DateAndOrTime.date	Y	date	The end date
end_DateAndOrTime.time	Y	time	The end time
curveType	Y	string	Type of period
quantity_Measure_Unit.name	Y	string	The identification of the formal code for a measurement unit
Reason	N	List of Reason	List of reasons associated to the timeseries
Available_Period	N	List of Period	List of periods associated to the timeseries

Available_Period			
Field	Mandatory	Data Type	Description
timeInterval	Y	timeInterval	The start and end date and time for a given interval
resolution	Y	string	The definition of the number of units of time that compose an individual step within a period
Point	Y	List of Point	List of points associated the period

Reason			
Field	Mandatory	Data Type	Description
code	Y	string	The code that represents the reason
text	Y	string	The text associated with the reason code

Point			
Field	Mandatory	Data Type	Description
position	Y	int	A sequential value representing the relative position within a given time interval
quantity	Y	decimal	The principal quantity identified for a point

timeInterval			
Field	Mandatory	Data Type	Description
start	Y	Datetime	The start date and time of the interval
end	Y	Datetime	The end date and time of the interval

13.5 Notification_MarketDocument

13.5.1 Format

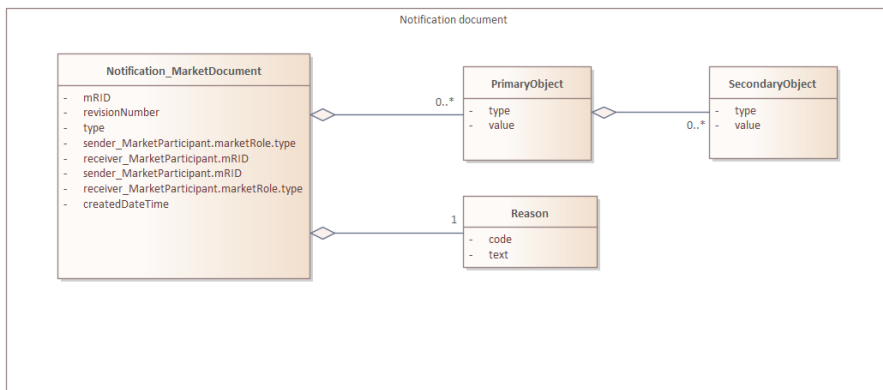

13.5.2 Attributes

Notification_MarketDocument			
Field	Mandatory	Data Type	Description
mRID	Y	string	Unique identifier for the MarketDocument
revisionNumber	Y	Int	Version number for the MarketDocument
type	Y	string	The coded type of the MarketDocument
sender_MarketParticipant.mRID	Y	string	The identification of the sender
sender_MarketParticipant.marketRole.type	Y	string	The role code associated with the sender
receiver_MarketParticipant.mRID	Y	string	The identification of the receiver
receiver_MarketParticipant.marketRole.type	Y	string	The role code associated with the receiver

createdDateTime	Y	Datetime	The date and time of the creation of the document
Reason	Y	List of Reason	List of reasons associated to the MarketDocument
PrimaryObject	N	List of Object	List of PrimaryObject instances related to the notification reason

PrimaryObject			
Field	Mandatory	Data Type	Description
type	Y	string	Code representing the type of the object
value	Y	string	Value of the object
SecondaryObject	N	List of Object	List of Secondary Object instances linked to the PrimaryObject

SecondaryObject			
Field	Mandatory	Data Type	Description
type	Y	string	Code representing the type of the object
value	Y	string	Value of the object

Reason			
Field	Mandatory	Data Type	Description
code	Y	string	The code that represents the reason
text	Y	string	The text associated with the reason code

13.6 Acknowledgement_MarketDocument

13.6.1 Format

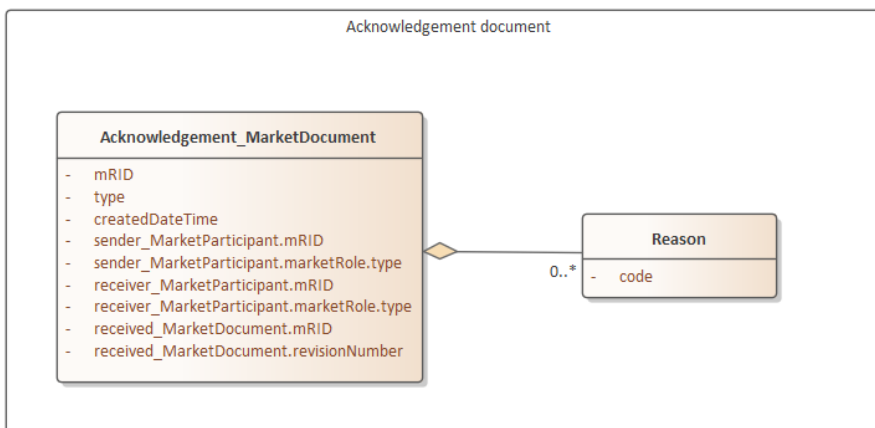

13.6.2 Attributes

Acknowledgement_MarketDocument			
Field	Mandatory	Data Type	Description
mRID	Y	string	Unique identifier for the MarketDocument
type	Y	string	The coded type of the MarketDocument
createdDateTime	Y	Datetime	The date and time of the creation of the document
sender_MarketParticipant.mRID	Y	string	The identification of the sender
sender_MarketParticipant.marketRole.type	Y	string	The role code associated with the sender
receiver_MarketParticipant.mRID	Y	string	The identification of the receiver
receiver_MarketParticipant.marketRole.type	Y	string	The role code associated with the receiver
received_MarketDocument.mRID	Y	string	The market document identification to which is acknowledged
received_MarketDocument.revisionNumber	Y	Int	The market document revision number to which is acknowledged
Reason	N	List of Reason	List of reasons associated to the MarketDocument

Reason			
Field	Mandatory	Data Type	Description
code	Y	string	The code that represents the acknowledgement status

13.7 Confirmation_MarketDocument

13.7.1 Format

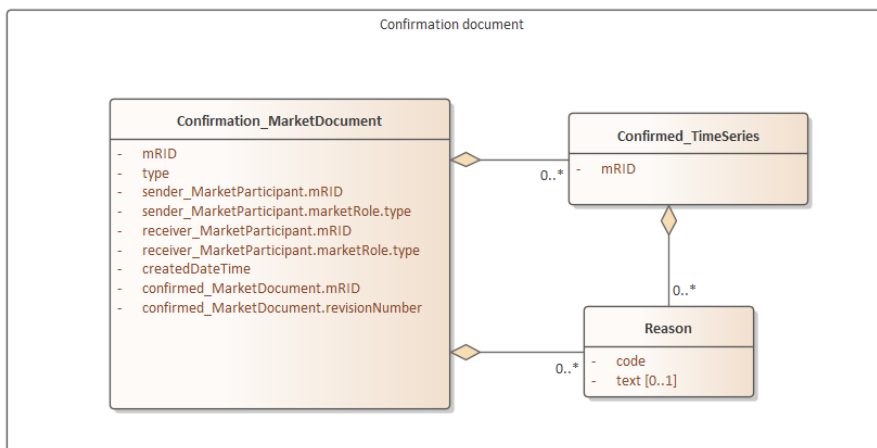

13.7.2 Attributes

Confirmation_MarketDocument			
Field	Mandatory	Data Type	Description
mRID	Y	string	Unique identifier for the MarketDocument.
type	Y	string	The coded type of the market document
sender_MarketParticipant.mRID	Y	string	The identification of the sender
sender_MarketParticipant.marketRole.type	Y	string	The role code associated with the sender
receiver_MarketParticipant.mRID	Y	string	The identification of the receiver
receiver_MarketParticipant.marketRole.type	Y	string	The role code associated with the receiver
createdDateTime	Y	Datetime	The date and time of the creation of the document
confirmed_MarketDocument.mRID	Y	string	The MarketDocument identification to which is replied
confirmed_MarketDocument.revisionNumber	Y	Int	The MarketDocument revision number to which is replied
Reason	N	List of Reason	List of reasons associated to the MarketDocument
Confirmed_TimeSeries	N	List of Confirmed_TimeSeries	List of timeseries that are replied to

Confirmed_TimeSeries			
Field	Mandatory	Data Type	Description
mRID	Y	string	Identification of the timeseries
Reason	N	List of Reason	List of reasons associated to the timeseries

Reason			
Field	Mandatory	Data Type	Description
code	Y	string	The code that represents the reply status.
text	Y	string	The text associated with the status code

13.8 BackupDeliveryPoints_MarketDocument

13.8.1 Format

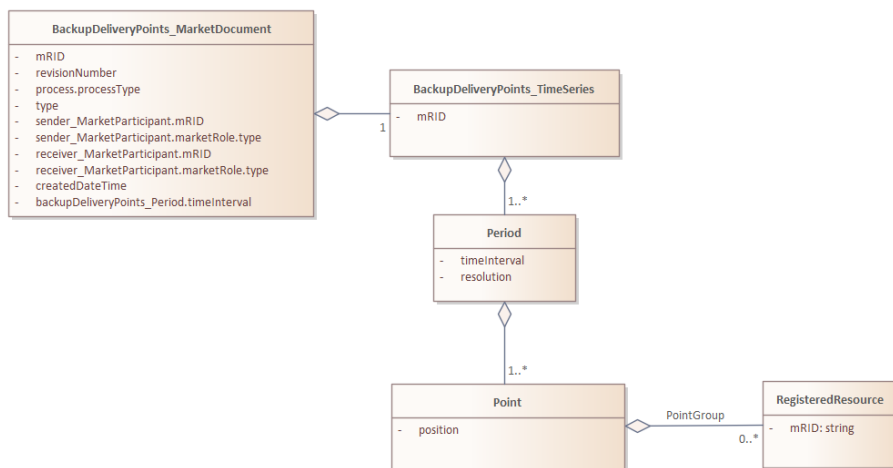

13.8.2 Attributes

BackupDeliveryPoints_MarketDocument			
Field	Mandatory	Data Type	Description
mRID	Y	string	Unique identifier for the MarketDocument
revisionNumber	Y	Int	Version number for the MarketDocument
type	Y	string	The coded type of the MarketDocument
process.processType	Y	string	The identification of the nature of process that the document addresses
sender_MarketParticipant.mRID	Y	string	The identification of the sender
sender_MarketParticipant.marketRole.type	Y	string	The role code associated with the sender
receiver_MarketParticipant.mRID	Y	string	The identification of the receiver
receiver_MarketParticipant.marketRole.type	Y	string	The role code associated with the receiver
createdDateTime	Y	Datetime	The date and time of the creation of the document
backupDeliveryPoints_Period.timeInterval	Y	timeInterval	The start and end date and time for a given interval
BackupDeliveryPoints_TimeSeries	Y	List of TimeSeries	List of BackupDeliveryPoints_TimeSeries

BackupDeliveryPoints_TimeSeries			
Field	Mandatory	Data Type	Description
mRID	Y	string	Identification of the timeseries

Period	Y	List of Period	List of periods associated to the timeseries
--------	---	----------------	--

Period			
Field	Mandatory	Data Type	Description
timeInterval	Y	timeInterval	The start and end date and time for a given interval
resolution	Y	string	The definition of the number of units of time that compose an individual step within a period
Point	Y	List of Point	List of points associated the period

Point			
Field	Mandatory	Data Type	Description
position	Y	int	A sequential value representing the relative position within a given time interval
PointGroup	N	List of RegisteredResource	A list of registered resources to which the interval of this bid is related

RegisteredResource			
Field	Mandatory	Data Type	Description
mRID	Y	string	EAN code of a Delivery Point

timeInterval			
Field	Mandatory	Data Type	Description
start	Y	Datetime	The start date and time of the interval
end	Y	Datetime	The end date and time of the interval

13.9 CRILevel_MarketDocument

13.9.1 Format

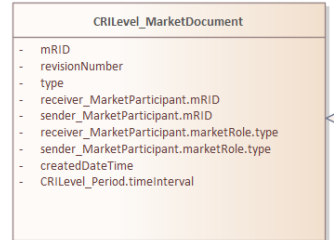
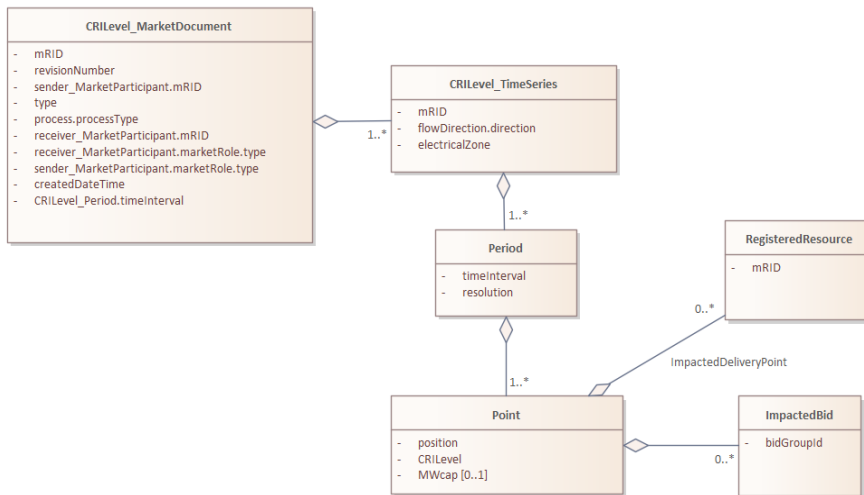

Deleted:

13.9.2 Attributes

CRILevel_MarketDocument			
Field	Mandatory	Data Type	Description
mRID	Y	string	Unique identifier for the MarketDocument
revisionNumber	Y	Int	Version number for the MarketDocument
type	Y	string	The coded type of the MarketDocument
<u>process.processType</u>	<u>Y</u>	<u>string</u>	<u>Code for type of process</u>
sender_MarketParticipant.mRID	Y	string	The identification of the sender
sender_MarketParticipant.marketRole.type	Y	string	The role code associated with the sender
receiver_MarketParticipant.mRID	Y	string	The identification of the receiver
receiver_MarketParticipant.marketRole.type	Y	string	The role code associated with the receiver
createdDateTime	Y	Datetime	The date and time of the creation of the document
CRILevel_Period.timeInterval	Y	timeInterval	The start and end date and time for a given interval
CRILevel_TimeSeries	Y	List of TimeSeries	List of CRILevel_TimeSeries

CRILevel_TimeSeries			
Field	Mandatory	Data Type	Description
mRID	Y	string	Identification of the timeseries
flowDirection.direction	Y	string	The coded identification of the direction of an energy flow
electricalZone	Y	string	Name of the electrical zone
Period	Y	List of Period	List of periods associated to the timeseries

Period			
Field	Mandatory	Data Type	Description
timeInterval	Y	timeInterval	The start and end date and time for a given interval
resolution	Y	string	The definition of the number of units of time that compose an individual step within a period
Point	Y	List of Point	List of points associated the period

Point			
Field	Mandatory	Data Type	Description
position	Y	int	A sequential value representing the relative position within a given time interval
CRILevel	Y	string	Category of the CRI level
MWcap	N	decimal	MW cap
ImpactedBid	N	List of ImpactedBid	List of impacted bids
ImpactedDeliveryPoint	N	List of RegisteredResource	List of impacted delivery points

ImpactedBid			
Field	Mandatory	Data Type	Description
bidGroupld	Y	string	The unique identification used to identify associated bids with each other

timeInterval			
Field	Mandatory	Data Type	Description
start	Y	Datetime	The start date and time of the interval
end	Y	Datetime	The end date and time of the interval

RegisteredResource			
Field	Mandatory	Data Type	Description
mRID	Y	string	EAN code of a delivery point

13.10 ActivationConfirmation_MarketDocument

13.10.1 Format

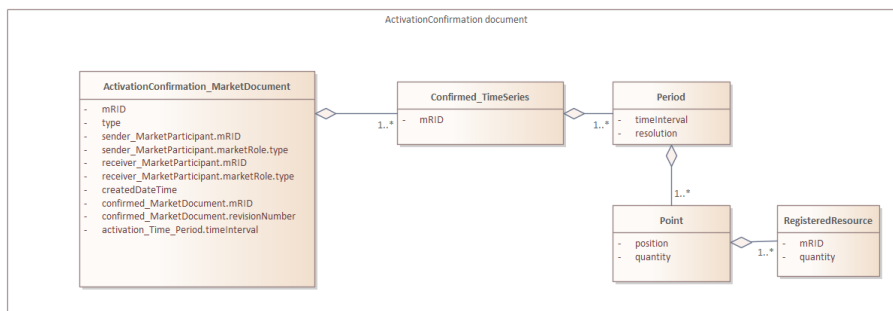

13.10.2 Attributes

ActivationConfirmation_MarketDocument			
Field	Mandatory	Data Type	Description
mRID	Y	string	Unique identifier for the MarketDocument.
type	Y	string	The coded type of the market document
sender_MarketParticipant.mRID	Y	string	The identification of the sender
sender_MarketParticipant.marketRole.type	Y	string	The role code associated with the sender
receiver_MarketParticipant.mRID	Y	string	The identification of the receiver
receiver_MarketParticipant.marketRole.type	Y	string	The role code associated with the receiver
createdDateTime	Y	Datetime	The date and time of the creation of the document
confirmed_MarketDocument.mRID	Y	string	The MarketDocument identification to which is replied
confirmed_MarketDocument.revisionNumber	Y	Int	The MarketDocument revision number to which is replied
activation_Time_Period.timeInterval	Y	timeInterval	The start and end date and time for a given interval
Confirmed_TimeSeries	Y	List of Confirmed_TimeSeries	List of timeseries that are replied to

Confirmed_TimeSeries			
Field	Mandatory	Data Type	Description
mRID	Y	string	Identification of the timeseries
Period	Y	List of Period	List of periods associated to the timeseries

Period			
Field	Mandatory	Data Type	Description

timeInterval	Y	timeInterval	The start and end date and time for a given interval
resolution	Y	string	The definition of the number of units of time that compose an individual step within a period
Point	Y	List of Point	List of points associated the period

Point			
Field	Mandatory	Data Type	Description
position	Y	int	A sequential value representing the relative position within a given time interval
quantity	Y	int	The principal quantity identified for a point
RegisteredResource	Y	List of RegisteredResource	List of registered resources associated to the point

timeInterval			
Field	Mandatory	Data Type	Description
start	Y	Datetime	The start date and time of the interval
end	Y	Datetime	The end date and time of the interval

RegisteredResource			
Field	Mandatory	Data Type	Description
mRID	Y	string	EAN code of a delivery point
quantity	Y	int	Expected contribution per delivery point. The principal quantity identified for a point. We require an accuracy of 1 MW.

Reason			
Field	Mandatory	Data Type	Description
code	Y	string	The code that represents the reply status.
text	Y	string	The text associated with the status code

13.11 BidConfirmation_MarketDocument

13.11.1 Format

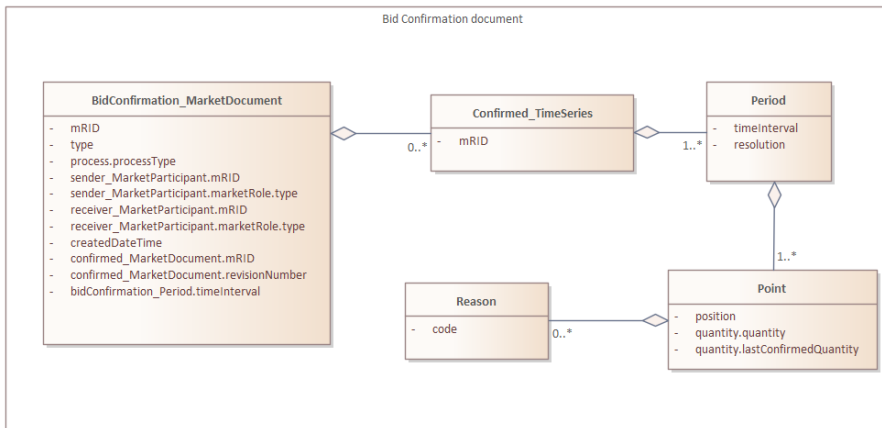

13.11.2 Attributes

BidConfirmation_MarketDocument			
Field	Mandatory	Data Type	Description
mRID	Y	string	Unique identification of the MarketDocument
type	Y	string	The coded type of the MarketDocument
process.processType	Y	string	The identification of the nature of process that the document addresses
sender_MarketParticipant.mRID	Y	string	The identification of the sender
sender_MarketParticipant.marketRole.type	Y	string	The role code associated with the sender
receiver_MarketParticipant.mRID	Y	string	The identification of the receiver
receiver_MarketParticipant.marketRole.type	Y	string	The role code associated with the receiver
createdDateTime	Y	Datetime	The date and time of the creation of the document
confirmed_MarketDocument.mRID	Y	string	The MarketDocument identification to which is replied
confirmed_MarketDocument.revisionNumber	Y	Int	The MarketDocument revision number to which is replied
bidConfirmation_Period.timeInterval	Y	timeInterval	The beginning and ending date and time of the period covered by the document
Confirmed_TimeSeries	Y	List of Confirmed_TimeSeries	List of timeseries that are replied to

Confirmed_TimeSeries			
Field	Mandatory	Data Type	Description
mRID	Y	string	Identification of the timeseries
Period	Y	List of Period	List of periods associated to the timeseries

Period			
Field	Mandatory	Data Type	Description
timeInterval	Y	timeInterval	The start and end date and time for a given interval
resolution	Y	string	The definition of the number of units of time that compose an individual step within a period
Point	Y	List of Point	List of points associated to the period

Point			
Field	Mandatory	Data Type	Description
position	Y	int	A sequential value representing the relative position within a given time interval
quantity.quantity	Y	decimal	The quantity (or Bid Volume)
quantity.lastConfirmedQuantity	Y	decimal	The last confirmed quantity (or Bid Volume)
Reason	N	List of Reason	List of reasons associated to the point

Reason			
Field	Mandatory	Data Type	Description
code	Y	string	Code of the reason

timeInterval			
Field	Mandatory	Data Type	Description
start	Y	Datetime	The start date and time of the interval
end	Y	Datetime	The end date and time of the interval

13.12 Request_MarketDocument

13.12.1 Format

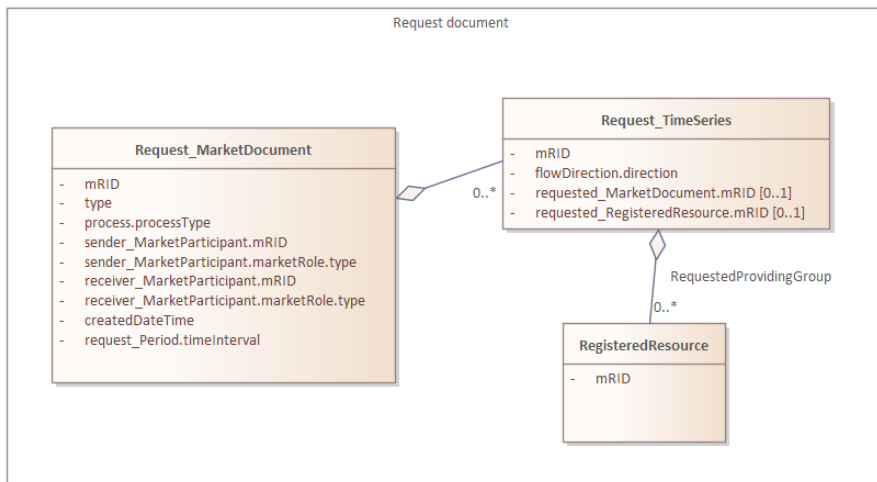

13.12.2 Attributes

Request_MarketDocument			
Field	Mandatory	Data Type	Description
mRID	Y	string	Unique identification of the MarketDocument
type	Y	string	The coded type of the MarketDocument
process.processType	Y	string	The identification of the nature of process that the document addresses
sender_MarketParticipant.mRID	Y	string	The identification of the sender
sender_MarketParticipant.marketRole.type	Y	string	The role code associated with the sender
receiver_MarketParticipant.mRID	Y	string	The identification of the receiver
receiver_MarketParticipant.marketRole.type	Y	string	The role code associated with the receiver
createdDateTime	Y	Datetime	The date and time of the creation of the document
request_Period.timeInterval	Y	timeInterval	The beginning and ending date and time of the period covered by the document
Request_TimeSeries	Y	List of Confirmed_TimeSeries	List of timeseries that are part of the request

Request_TimeSeries			
Field	Mandatory	Data Type	Description

mRID	Y	string	Identification of the timeseries
flowDirection.direction	Y	string	The coded identification of the direction of an energy flow
requested_MarketDocument.mRID	N	String	Unique identification of the requested MarketDocument
requested_RegisteredResource.mRID	N	String	EAN code of a delivery point
RequestedProvidingGroup	N	List of RegisteredResource	A list of registered resources that define a Providing Group

timeInterval			
Field	Mandatory	Data Type	Description
start	Y	Datetime	The start date and time of the interval
end	Y	Datetime	The end date and time of the interval

RegisteredResource			
Field	Mandatory	Data Type	Description
mRID	Y	string	EAN code of a delivery point