

iCAROS phase 1 – Schedules

Implementation guide

07/11/2022 – Training SA part 1

Agenda

1. General presentation
2. Demo
3. Questions

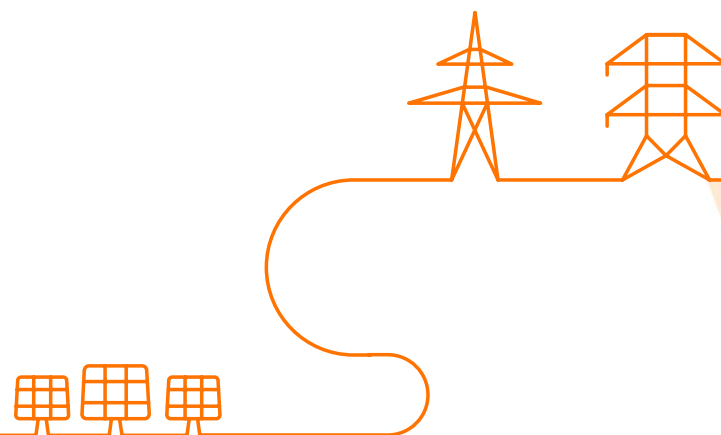

iCAROS = Integrated Coordination of Assets for Redispatching and Operational Security

Business Scope

Exchange of operational data [from LT to real-time]

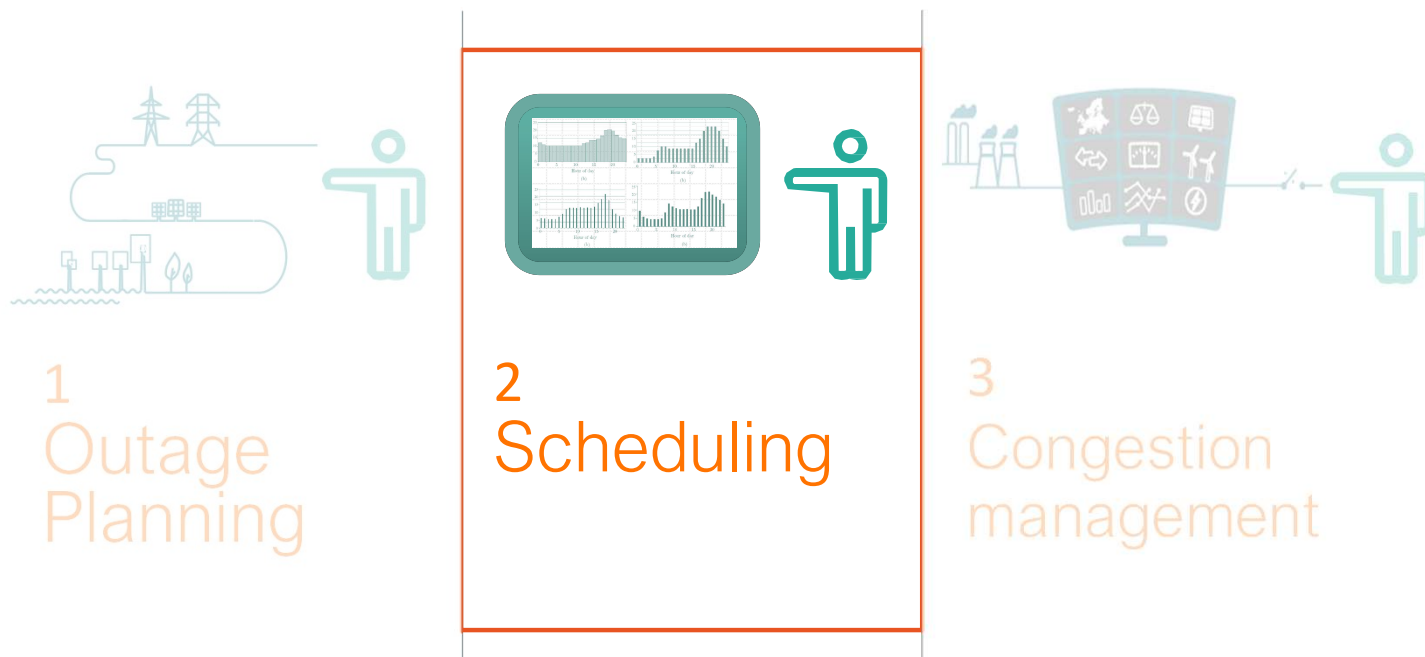

iCAROS
Phase 1

- **Technical Facility >= 25 MW**: Mandatory signature of SA contract

SCHEDULING

AS IS process to be replaced in iCAROS phase 1

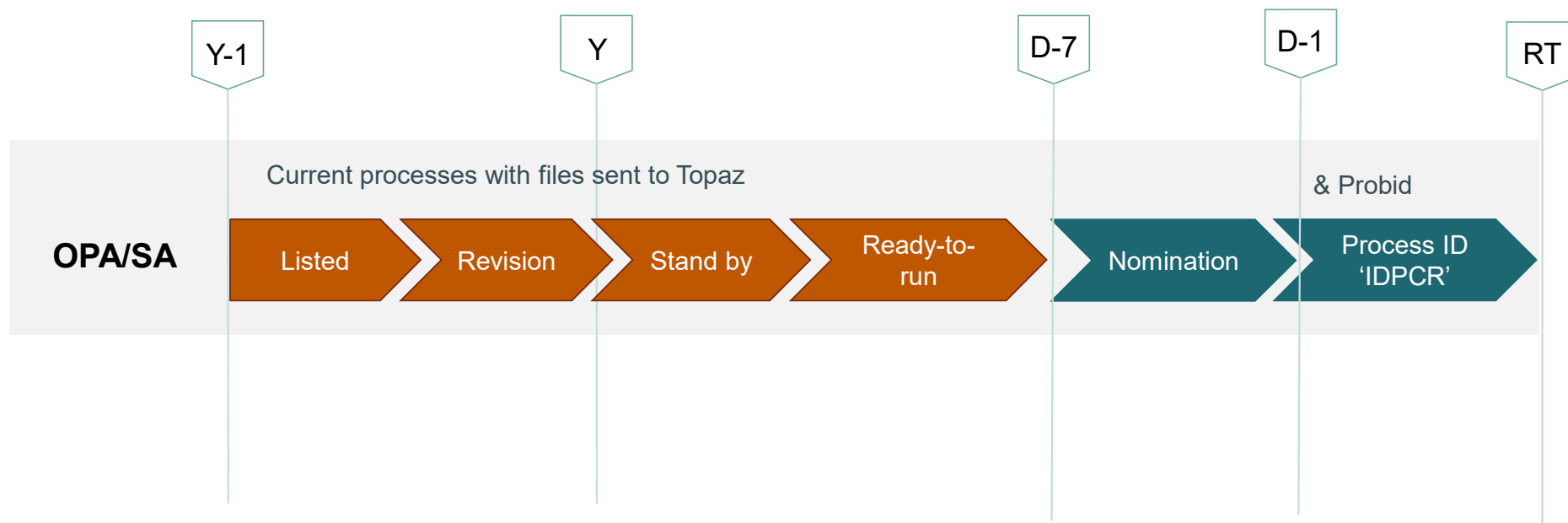

SCHEDULING

TO BE – iCAROS Phase 1

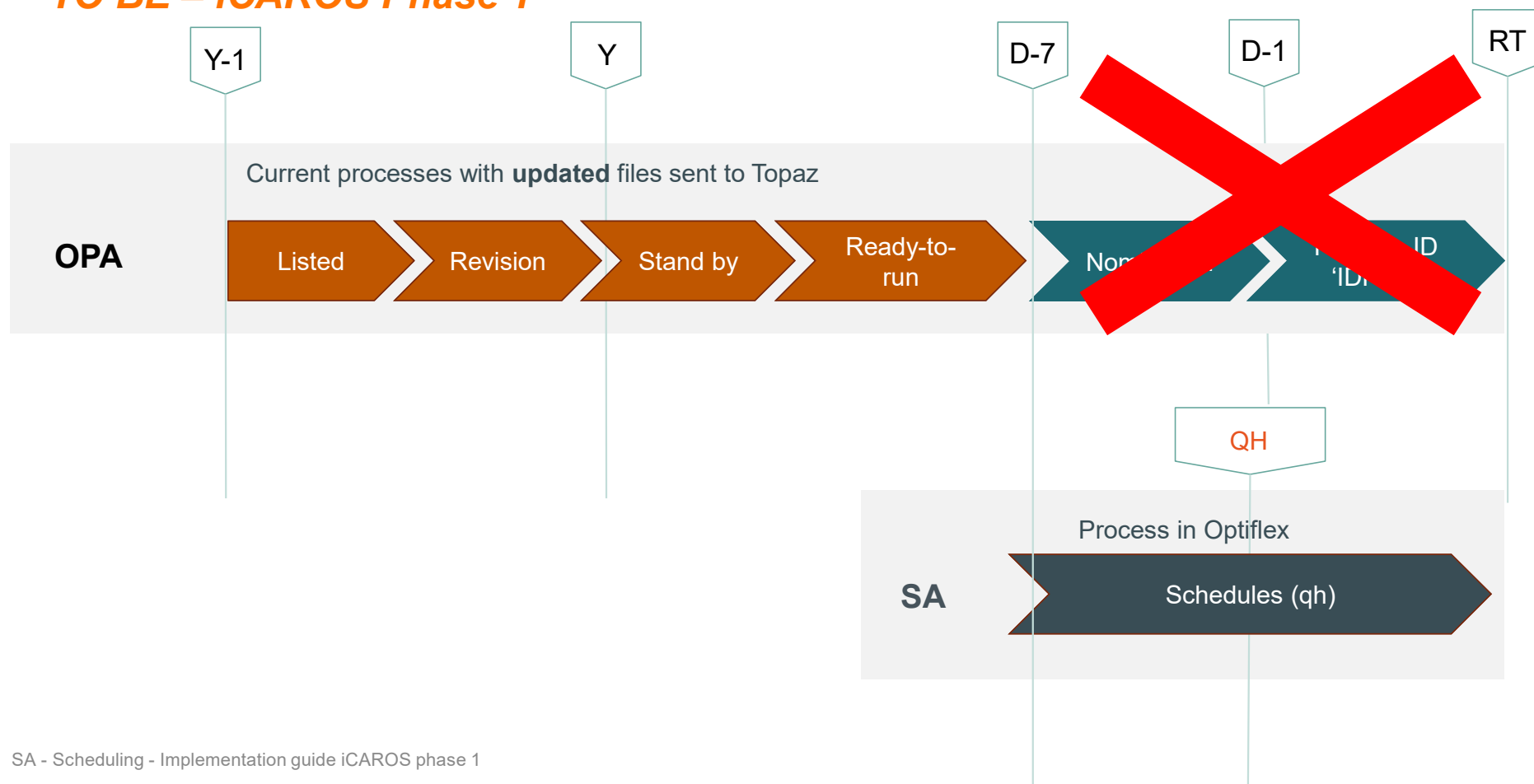

SCHEDULING

Processes

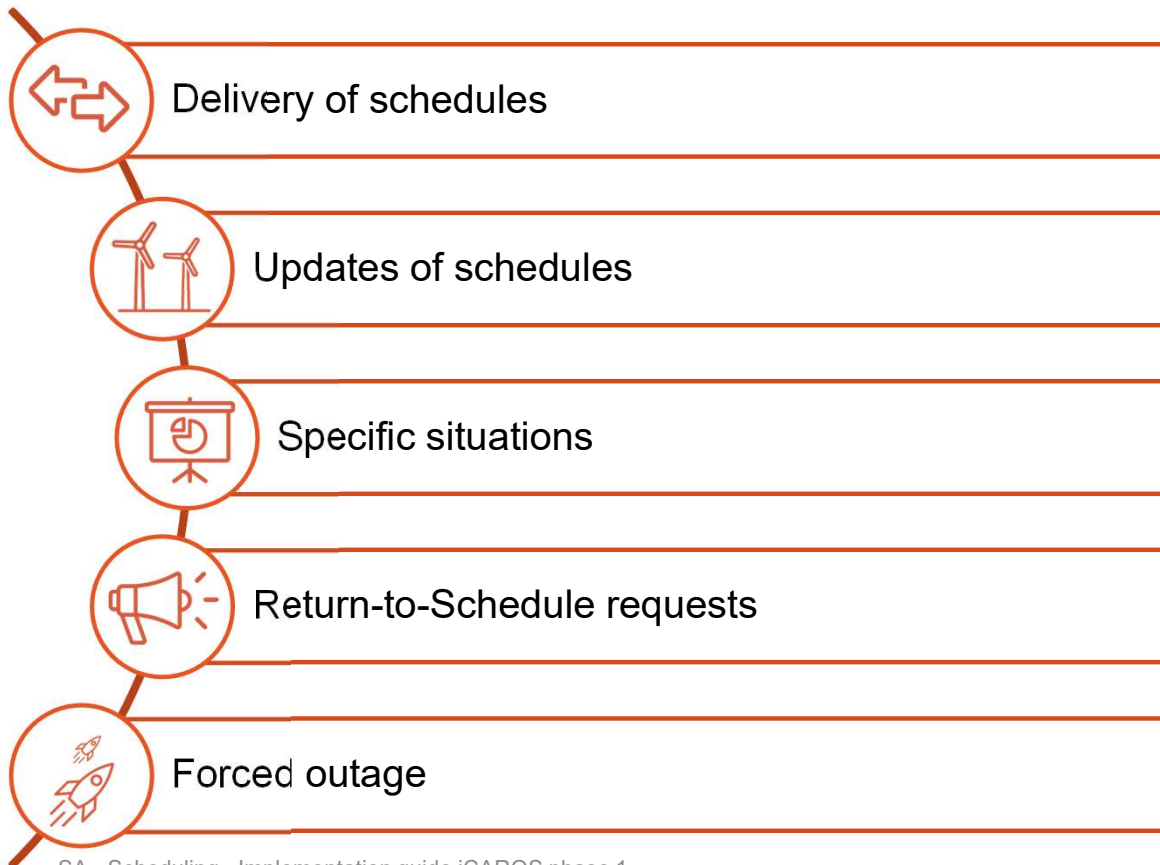

SCHEDULING

Timeline of processes

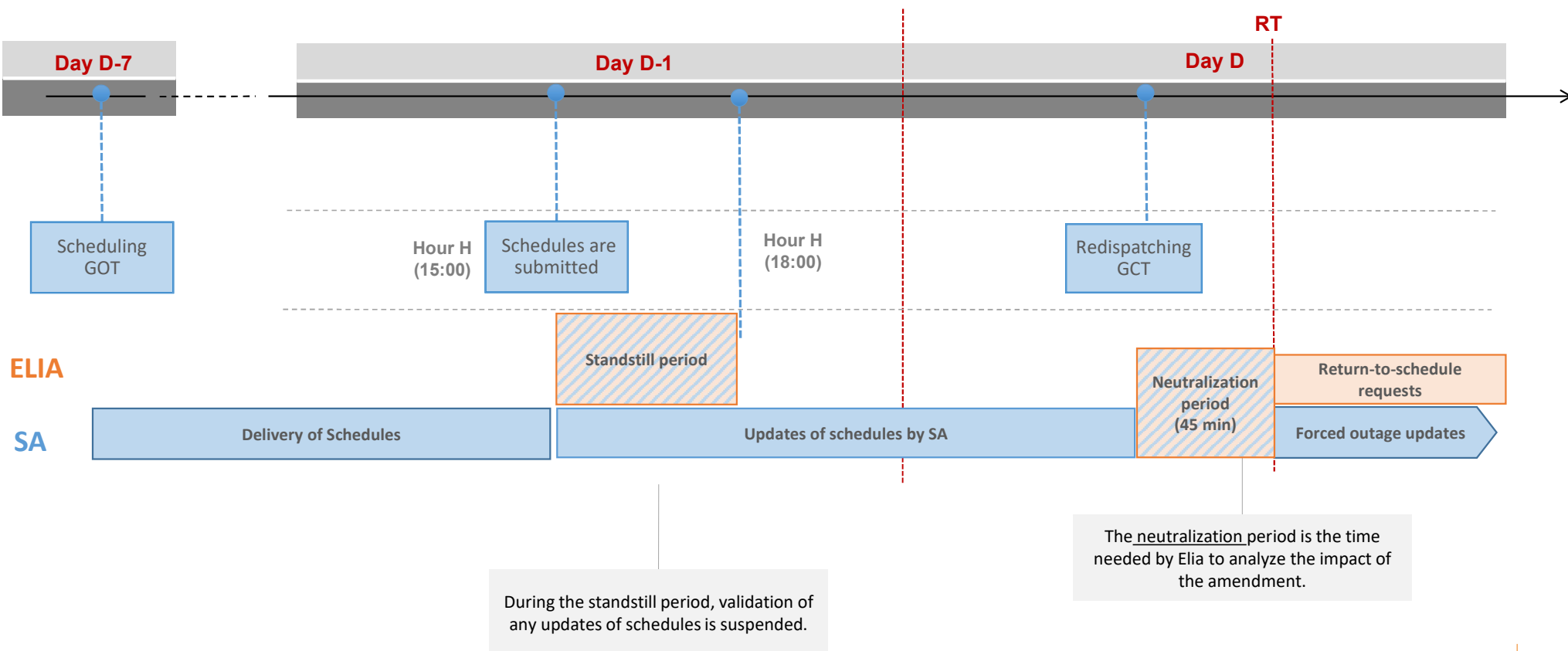

SCHEDULING

Delivery of schedules

- The schedules must be submitted at the latest in D-1 15.00 for all Delivery Points in the portfolio of a Scheduling Agent.
- The granularity of the message is:
 - Per DP
 - Per execution day
- The schedules are
 - In MW with a granularity of 0,1 MW
 - Positive if offtake
 - Negative if production
- The schedule submitted message are subject to validation rules described in the Technical Guide and will be answered accordingly:

Elia reply

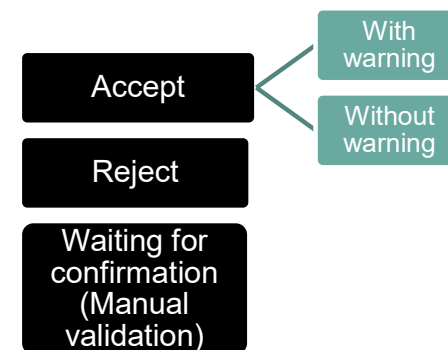

SCHEDULING

Delivery of schedules - example

A **wind park A** which is a Power Park Module (PPM) whose primary energy source is wind

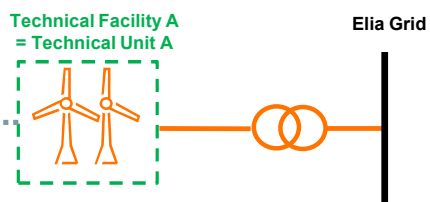

Delivery Point A

07/11/2022	00:00	00:15	23:45
Schedules	-45,1	-45,1	

A **CCGT B** which is a synchronous Power Generating Module composed of three Technical Units (TU): two gas turbines and one steam turbine

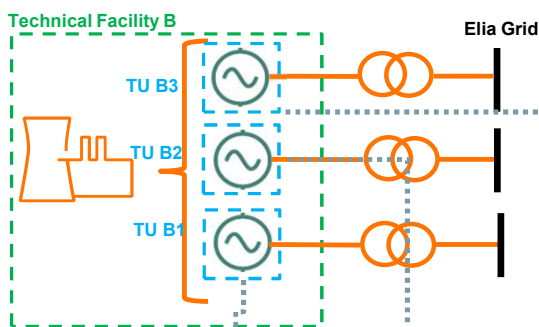

Delivery Point B1

07/11/2022	00:00	00:15	23:45
Schedules	-45,1	-45,1	-23,5

Delivery Point B2

07/11/2022	00:00	00:15	23:45
Schedules	0,0	0,0	0,0

Delivery Point B3

07/11/2022	00:00	00:15	23:45
Schedules	-45,1	-45,1	-14,5

**SA needs to submit the schedules at Delivery Point (DP) level:
1 message per DP for all DPs**

SCHEDULING

Delivery of schedules - example

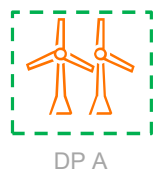

		00.00	00.15	00.30	00.45	01.00
OPA	Availability plan status	A	A	A	A	A
	$P_{max, avail}$					
SA	Schedule	-45,1	-42,2	-43,5	-45,1	-42,2

.....

.....

		23.15	23.30	23.45
OPA	Availability plan status	A	A	A
	$P_{max, avail}$			
SA	Schedule	-12,3	-5,4	0

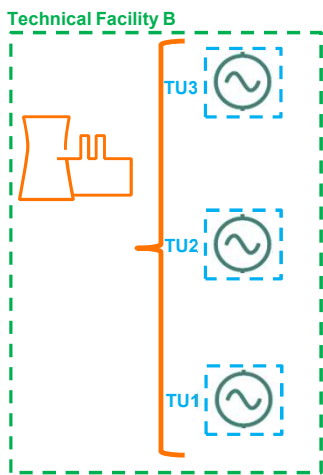

		00.00	00.15	00.30	00.45	01.00
DP B3	OPA	A	A	A	A	A
	$P_{max, avail}$					
SA	Schedule	-45,1	-42,2	-43,5	-45,1	-42,2
DP B2	OPA	U	U	U	U	U
	$P_{max, avail}$	0	0	0	0	0
SA	Schedule	0	0	0	0	0
DP B1	OPA	A	A	A	A	A
	$P_{max, avail}$					
SA	Schedule	0	-5,0	-10,0	-15,0	-20,5

.....

.....

.....

.....

.....

		23.15	23.30	23.45
OPA	Availability plan status	A	A	A
	$P_{max, avail}$			
SA	Schedule	-12,3	-5,4	0
OPA	Availability plan status	U	U	U
	$P_{max, avail}$	0	0	0
SA	Schedule	-100	-100	-100
OPA	Availability plan status	A	A	A
	$P_{max, avail}$			
SA	Schedule	-120,0	-120,0	-120,0

Schedule Incoherency notification

SCHEDULING

Update of schedules

- A schedule can be updated until RD GCT (45 min before the beginning of the concerned quarter-hour)
- A schedule update has the same properties:
 - Granularity of the message:
 - per DP
 - Per execution day
 - The schedules are
 - In MW with a granularity of 0,1 MW
 - Positive if offtake
 - Negative if production
- A schedule update is sent to the same queue.
- The schedule submitted message are subject to validation rules described in the Technical Guide and will be answered accordingly:

1st reply

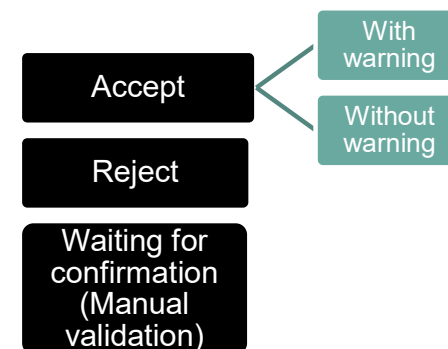

SCHEDULING

Update of schedules – example (1/2)

Technical Facility B

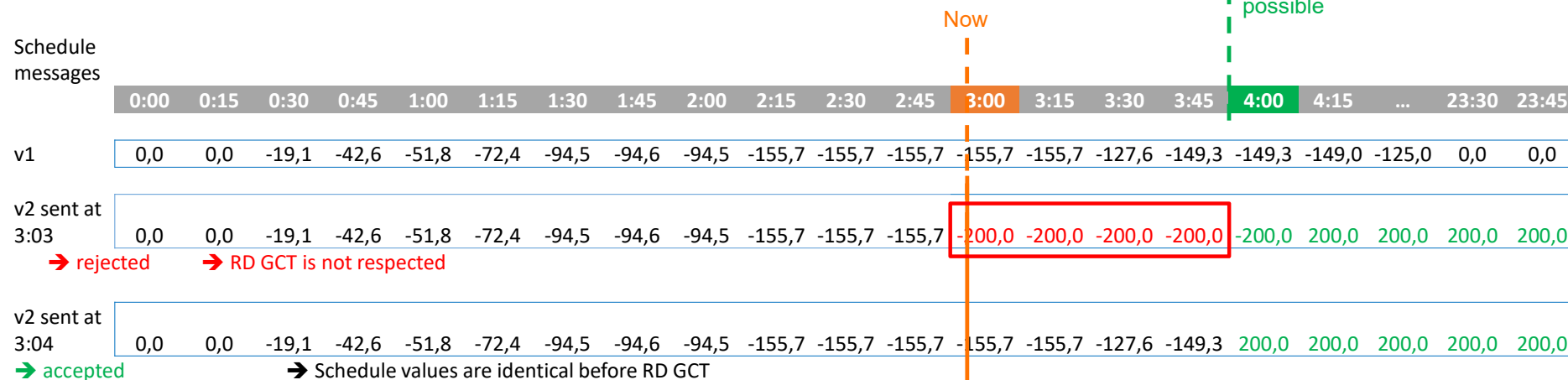
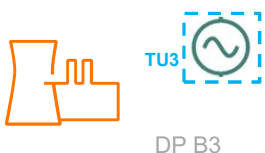

SCHEDULING

Update of schedules – example (2/2)

Technical Facility B

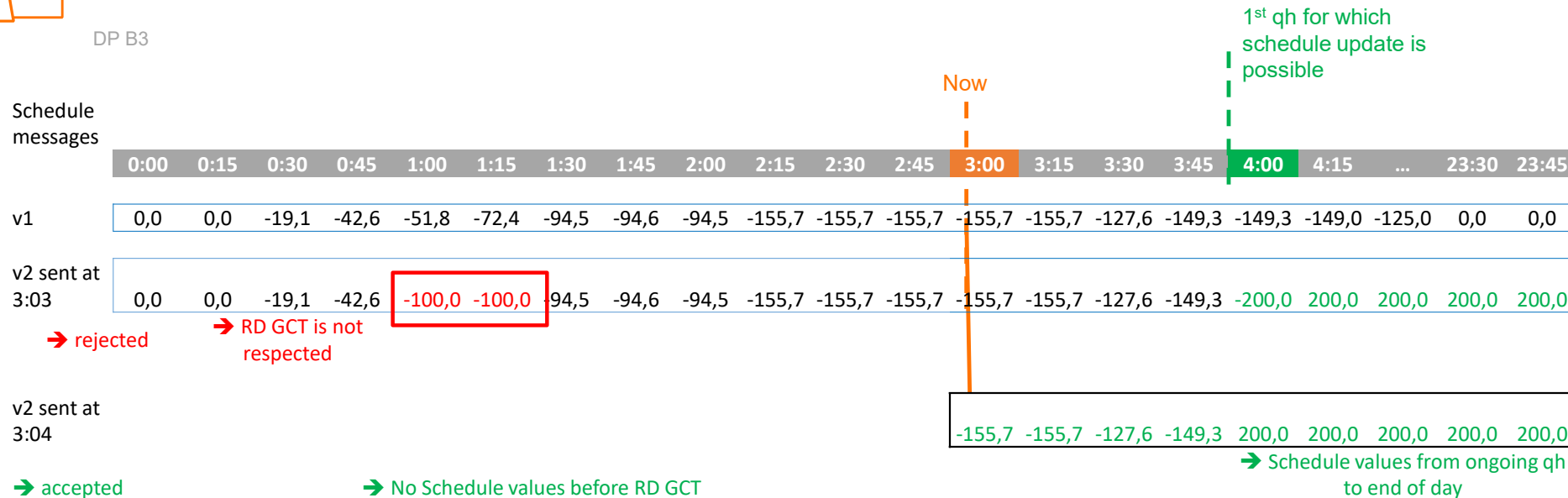
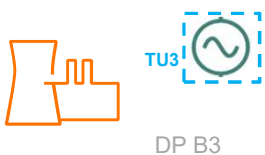

SCHEDULING

Specific situations

In the following cases the schedule update must be **requested to Elia for approval**:

- A schedule update in the **opposing direction of an earlier requested activation** of flexibility for redispatching on the concerned asset for the concerned period **will be rejected**
- A schedule update **in violation of a Must-Run or May-Not-Run agreement** with Elia is **subject to validation by Elia**;
- A schedule update for an offshore PPM, submitted **between the notice**, by Elia, of an upcoming **Sea Storm**, and **the end of the second hour after** this Sea Storm is **subject to validation by Elia**

SCHEDULING

Specific situations – example for RD activation

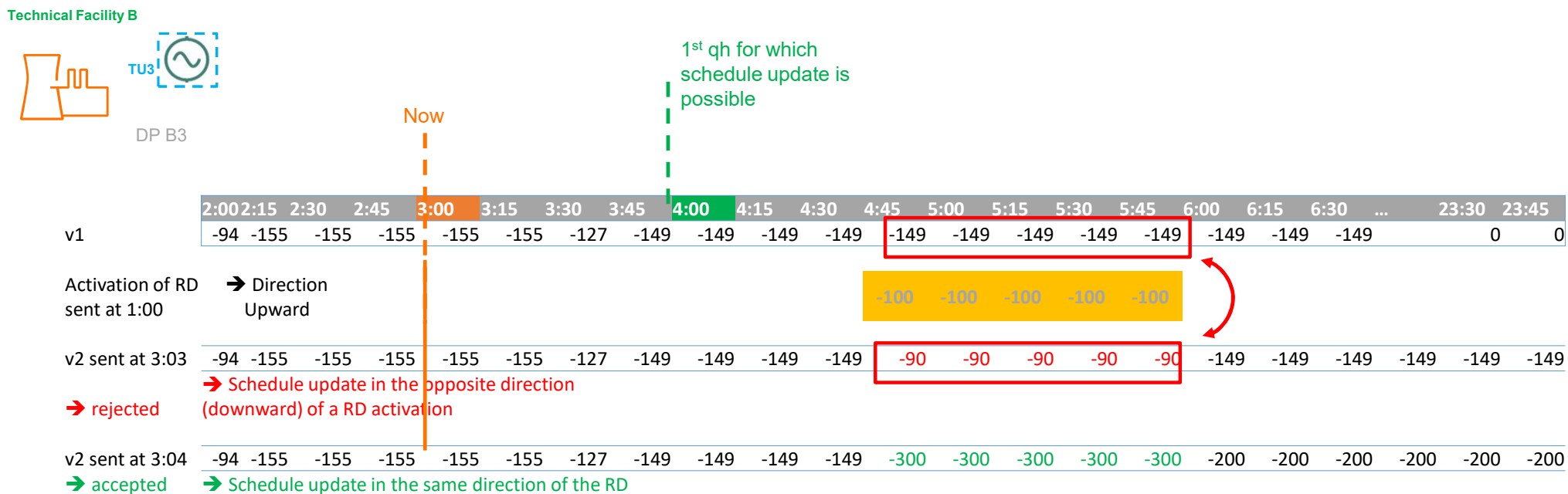

SCHEDULING

Specific situations – example for Must Run / May Not Run

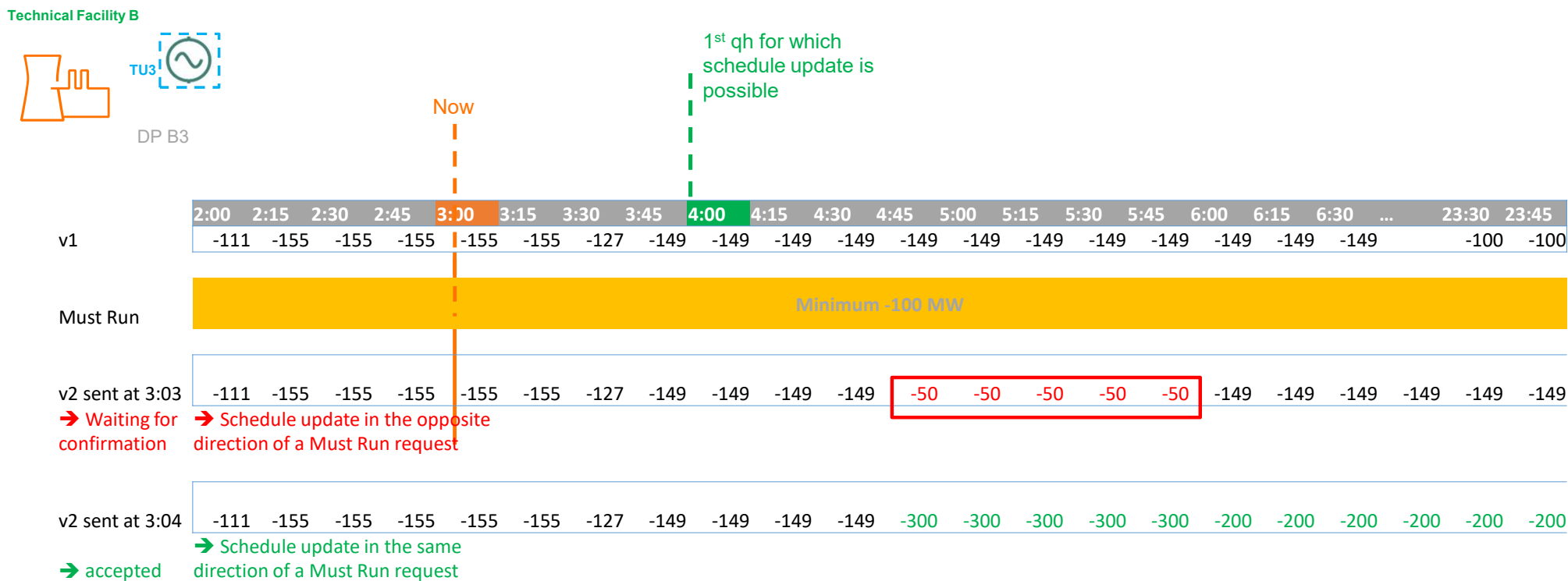

SCHEDULING

Specific situations – example for Storm

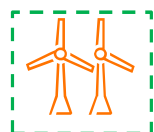

DP A

Now

1st qh for which
schedule update is
possible

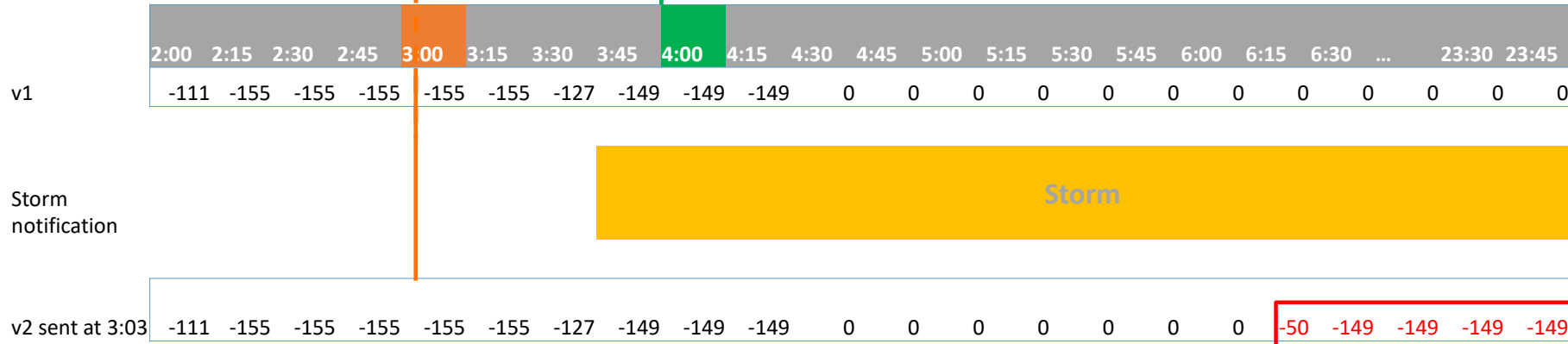

→ waiting for confirmation → schedule update during a storm

SCHEDULING

Return to schedule request

- A Return-to-Schedule request sent to a Technical Unit includes an Authorized zone. SA only needs to react if schedule deviation is not in the authorized zone.
- This request:
 - Applies to the quarter-hour after the moment of the request and all following quarter-hours for which the RD GCT has passed
 - is only sent to Technical Units which are coordinable in the direction of the Authorized zone.

High or Medium CRI in UP direction

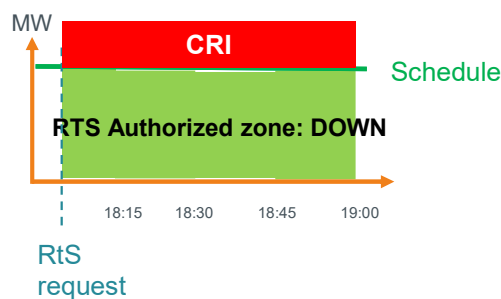

High or Medium CRI in DOWN direction

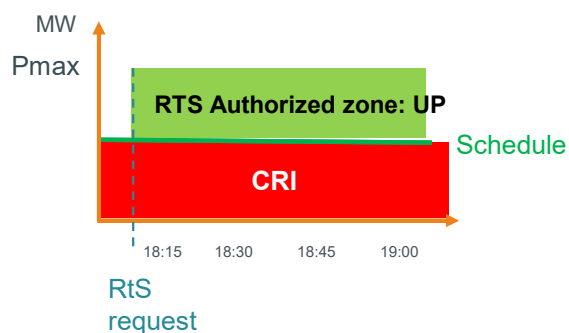

High or Medium CRI in UP & DOWN direction

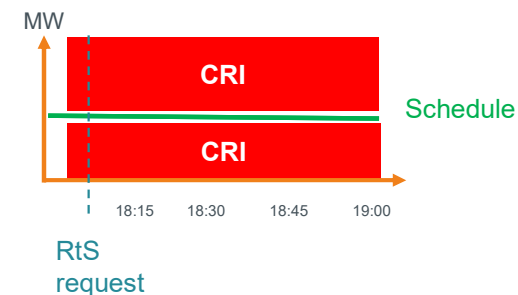

SCHEDULING

Return to schedule request - example

A Return-to-Schedule request is sent to DP B1, B2 & B3 with an Authorized zone: [P_{schedule}; 0]

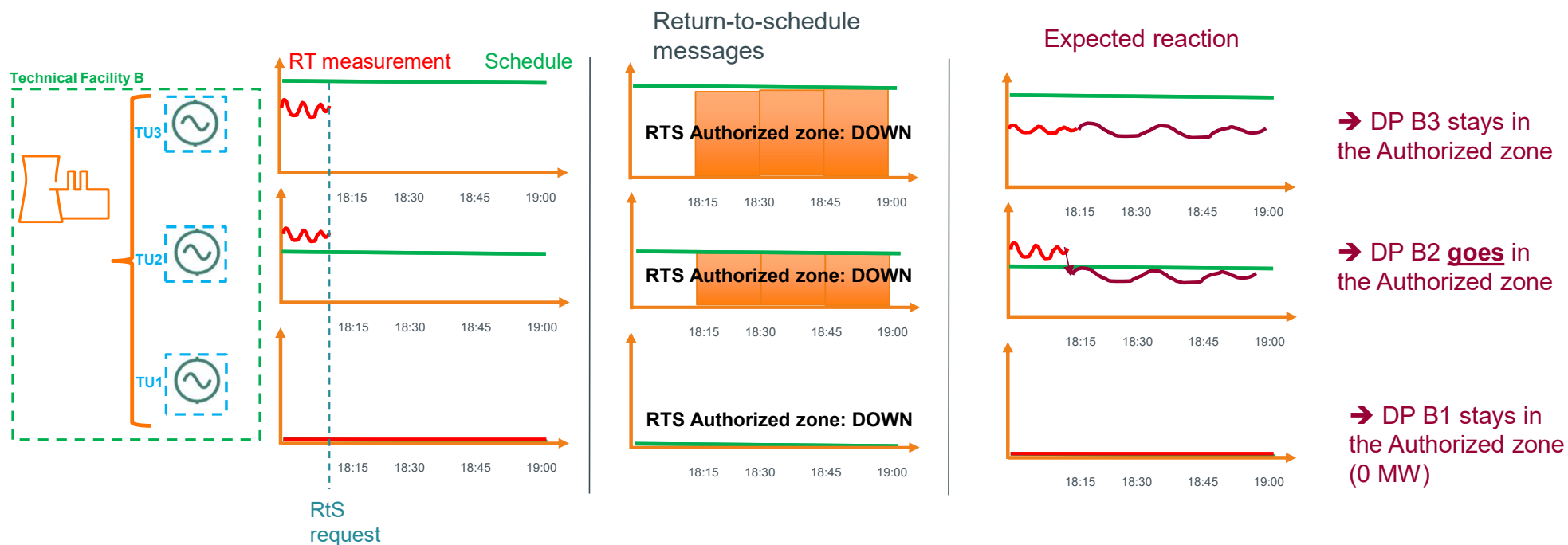

SCHEDULING

Forced outage process

- **The forced unavailability update** procedure is performed in coordination by the **Outage Planning Agent** through the data exchange for Outage Planning.
- The Scheduling Agent has to update his schedule.
- RD GCT validation rules does not apply on Forced outage communication.

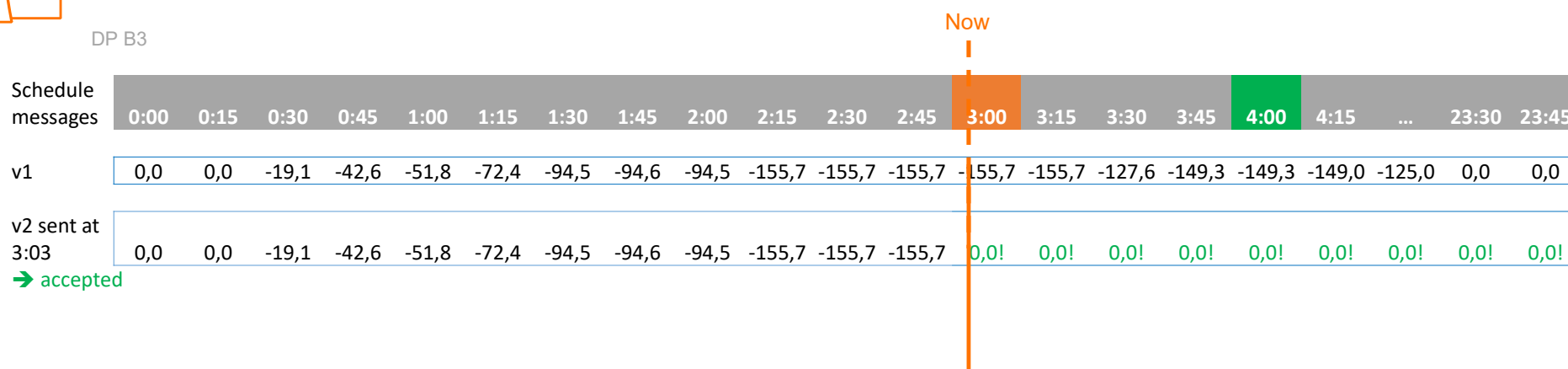
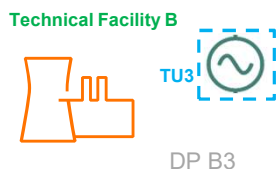

SUBMITTING SCHEDULES

B2B & B2C possibilities

Schedules can be sent through two channels :

- exchanges of json messages via the **External Communication layer**. Information related to the external communication layer and the json messages can be found in the Technical Guide.
- sending of an excel file via the **OPTIFLEX web interface**. Information related to the OPTIFLEX web interface can be found in the OPTIFLEX user manual.

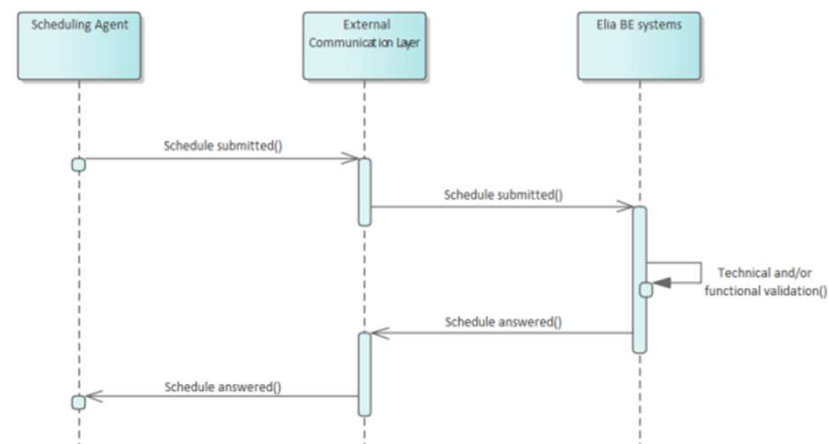

Optiflex

Demo

